

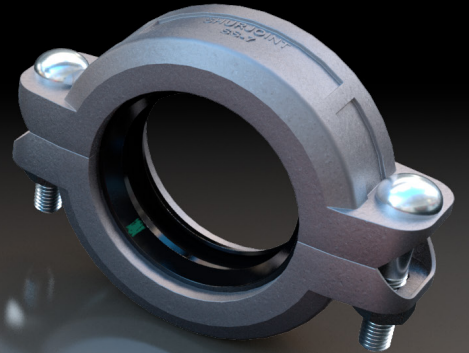

SHURJOINT®

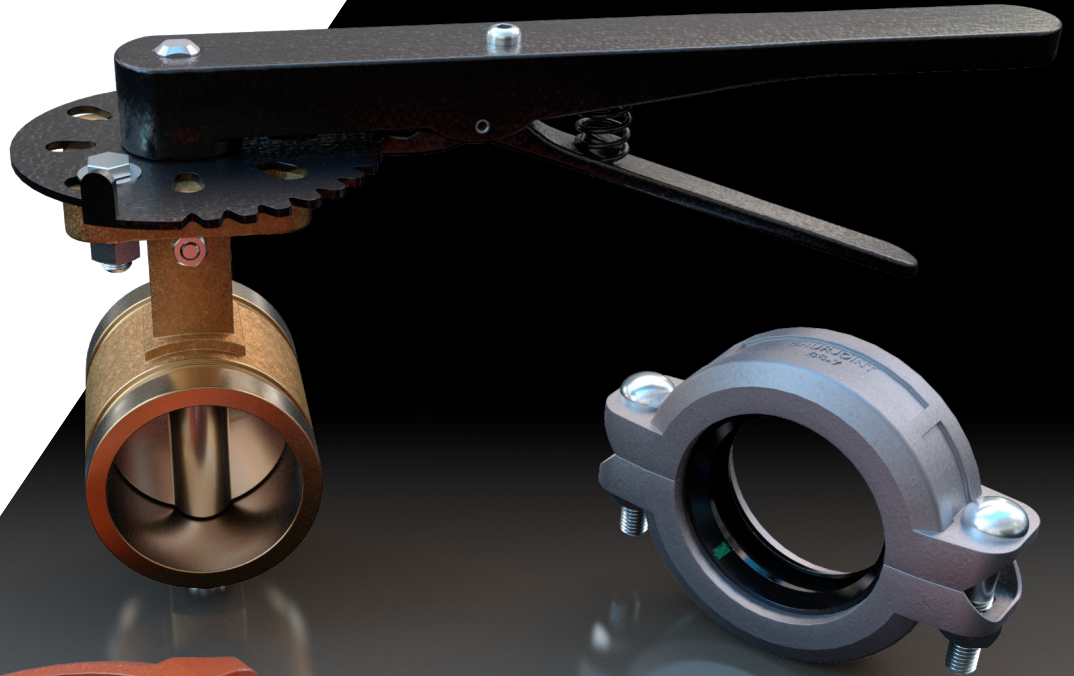

north american catalog

shurjoint.apollovalves.com
customer service 704.841.6000



integrated
piping systems

CONTENTS

H3 - H11

GENERAL INFORMATION

H12 - H47

GROOVED MECHANICAL COUPLINGS, FLANGE ADAPTERS & MECHANICAL TEES

H48 - H67

CAST & WROUGHT GROOVED FITTINGS

H68 - H87

STAINLESS STEEL SERIES

H88 - H103

VALVES & FLOW CONTROL COMPONENTS

H104 - H113

RING JOINT, SHOULDERED & PLAIN-END COUPLINGS

H114 - H119

HDPE SERIES

H120 - H131

COPPER SERIES

H132 - H137

AWWA DUCTILE IRON SERIES

H138 - H161

TECHNICAL INFORMATION

Mechanical couplings were first developed in the 1920's and evolved into grooved mechanical couplings during the 1950's & 60's. This revolution was further spurred in the latter half of the 20th century by advanced engineering and innovative materials such as ductile iron and EPDM elastomers.

The history of Shurjoint dates back to 1974, when the founders produced their first grooved couplings. These first couplings were produced from malleable iron, the casting material of choice at this time. Before long, foundry production was converted to ductile iron. Ductile iron was the ideal raw material, providing for precision castings and superior strength, without the need for further heat treatment. EPDM (ethylene propylene diene monomer) provided a great advancement in synthetic rubber elastomer compounds. This new compound offered a service life equal to or in some cases longer than that of carbon steel pipe. EPDM was an ideal gasket material for grooved piping systems.

With over four decades of experience, Shurjoint is recognized as a world leader in the design and manufacture of mechanical piping components. Shurjoint has developed and currently offers 3000 individual piping components in sizes from 1/2" to 104", for use with a variety of piping materials including carbon steel, stainless steel, ductile iron, PVC, HDPE, CPVC and copper tubing.

Our mission is to supply the highest quality products to customers worldwide with an unmatched level of customer service at a superior value. In addition to these hallmarks, Shurjoint continuously invests in research, engineering and development, resulting in innovative products and new solutions for the changing needs of industry.

TYPICAL APPLICATIONS

- HVAC
- FIRE PROTECTION
- WATER SUPPLY & TREATMENT
- PLUMBING
- MUNICIPAL
- FOOD PROCESSING
- PULP & PAPER
- AGRICULTURE
- REVERSE OSMOSIS
- DESALINATION
- MINING & TUNNEL BORING
- MARINE
- GAS
- CHEMICAL
- OIL
- AIR

MODEL NUMBER	PAGE	MODEL NUMBER	PAGE	MODEL NUMBER	PAGE	MODEL NUMBER	PAGE	MODEL NUMBER	PAGE	MODEL NUMBER	PAGE
10EP	65	7112	47	A10-R	131	DE30-GG	122	RX-3000	106	SS-50F	77
11EP	65	7113	47	A11	130	G28	42, 42	RX-3770	107	SS-60	75
20EP	65	7120	48	A20	130	H305	110	SJ-200	88	SS-80	79
22EP	65	7121	49, 50	A25	131	H307	111	SJ-C300	125	SS-723	80
35EP	65	7130	48	A50	131	H312	112	SJ-300N	89, 90	SS-726	81
49	30	7135	48	A505	128	L11-3D	58	SJ-400	83	SS-1200	73
55	63	7137	53	A507	129	L11-5D	59	SJ-500L	91	W110LR	54
56	64	7150	51	A512	129	L11-6D	60	SJ-500W	91	W111LR	54
57	64	7150-F	63	A60	130	L22-3D	58	SJ-600L	82	W120	54
58	64	7150-M	63	BH-22C	99	L22-5D	59	SJ-600W	82	W121	55
59	64	7151	51	C-7	28, 42	L22-6D	60	SJ-630		W135	57
651	95	7160	52	C10	119	L30-3D	58	SJ-900	92	W137	57
79	108	7160-H	52	C11	119	L30-5D	59	SJ-915	93	W150	56
725-G	96	7160-P	52	C20	119	L30-6D	60	SJ-930	94	W151	56
726	97	7160-T	53	C21	120	L45-3D	58	SS-7	69, 84, 151	W160	52, 54
728	98	7170	32	C26	120	L45-5D	59	SS-7X	70, 84	XH-70EP	25
901	61	7180	33	C50	120	L45-6D	60	SS-8	71, 84	XH-1000	26, 42
903	61	7181	33	C52	121	L60-3D	58	SS-8X	72, 84	Z07	15 - 16, 38, 150
7041	29, 43	7705	23, 41, 150	C55	121	L60-5D	59	SS-10	75	Z07N	17, 39
7043	31, 43	7706	24, 41, 150	C60	119	L60-6D	60	SS-11	75	M07	13 - 14, 38
7110	47	7707	20, 40	C305	116, 151	L90-3D	58	SS-20	75	Z05	18 - 19, 39, 150
7110-B	62	7707-L	22, 40	C306	117, 151	L90-5D	59	SS-21	76		
7110-DR	62	7707-N	21, 40	C307	118, 151	L90-6D	60	SS-21F	77		
7110-LR	53	7721	34 - 35	C341	118	R-88	102, 103, 105	SS-28	74, 85		
7111	47	7722	36 - 37	C723	123	R-88N	104	SS-41	78		
7111-LR	53	A10	130	C726	124	RH-1000	106	SS-50	76		

NOTES

1. Always read and understand all Shurjoint installation instructions before installing any Shurjoint product.
2. Always depressurize and drain the piping system before attempting disassembly, adjustment or removal of any piping components.
3. Designers must know and understand all relevant building and or piping standards, codes and specifications. It is the responsibility of the designer to select and or specify the appropriate product for the intended use and service.
4. Always refer to the maximum pressure rating and service temperature range allowed for Shurjoint products and ensure that they are used within these parameters.
5. Special attention is required for selection of suitable gasket grades for the intended service application.
6. All information and data contained herein supersede all previous published data. Shurjoint reserves the right to change product designs and or specifications without notice and or obligation.
7. Please refer to www.shurjoint.apollovalves.com for the latest information.

DUCTILE IRON

Superior tensile strength with good castability.

GRAY IRON

Excellent castability, but "brittle", with less strength.

MALLEABLE IRON

Stronger than gray iron, but poor castability.

International ductile iron specifications equivalent to ASTM A536 Gr. 65-45-12 and or ASTM A395 Gr. 65-45-15 are:

SAE J434; D4512
 EN1563: EN=GJS-450-10 or EN-GJS-450-15
 JIS G5502: FCD450-10
 SABS 936/937: SG42

DUCTILE IRON HOUSING MATERIAL

Ductile iron is an ideal material for grooved mechanical components, as it provides similar or greater strength to that of wrought or cast steel piping materials such as; forged steel flanges - ASTM A105, carbon steel valves - ASTM A216 WCB, wrought carbon steel pipe - ASTM A53 Gr. B, etc. Most Shurjoint components are made of ductile iron conforming to ASTM A536 gr. 65-45-12 and or ASTM A395 Gr. 65-45-15.

Ductile iron was first invented in the U.S.A. and U.K. in the late 1940's. Superior strength was achieved by crystallizing graphite in the shape of nodules. The result was ductile iron that had tensile and yield strength properties that were equal to or great than some steel castings. This superior strength combined with ductile iron's excellent castability helped to reduce the weight and cost of many components. Because of these advantages and benefits, many components have been converted from gray iron, malleable iron and steel castings to ductile iron over the past 60 years.

PHYSICAL STRENGTH OF MATERIALS COMPARATIVE

MATERIAL	ASTM DESIGNATION	TENSILE STRENGTH MIN. PSI (MPA)	YIELD STRENGTH MIN. PSI (MPA)	ELONGATION IN 2", %
Ductile Iron Castings	A536: Gr. 65-45-12	65,000 (448)	45,000 (310)	12
Ductile Iron Castings	A395: Gr. 65-45-15	65,000 (448)	45,000 (310)	15
Forged Carbon Steel	A105	70,000 (485)	40,000 (250)	20
Cast Carbon Steel	A216: WCB	70,000 (485)	36,000 (205)	22
Carbon Steel Pipe	A53: Gr. B	60,000 (415)	35,000 (240)	(29.5)
Malleable Iron Castings	A47: Gr. 32510	51,000 (345)	32,000 (224)	10
Gray Iron Castings	A126: Gr. B	31,000 (214)	Not Specified	Not Specified

ASTM A536

GRADE 65-45-12 (UNS F33100)

CHEMICAL REQUIREMENTS	MINIMUM	MAXIMUM
Carbon, %	3.0	3.9
Silicon, %	2.5	3.0
Manganese, %	0.1	0.4
Phosphorus, %		0.07
Sulfur, %		0.02
Magnesium, %	0.03	0.05
Chromium, %		0.1
PHYSICAL PROPERTIES		
Tensile Strength, psi (MPa)	65,000 (448)	—
Yield Strength, psi (MPa)	45,000 (310)	—
Elongation, %	12	—

ASTM A395

GRADE 65-45-15 (UNS F33100)

CHEMICAL REQUIREMENTS	MINIMUM	MAXIMUM
Carbon, %	3.0	
Silicon, %		2.5
Manganese, %	Not specified	
Phosphorus, %		0.08
Sulfur, %	Not specified	
Magnesium, %	Not specified	
Chromium, %	Not specified	
PHYSICAL PROPERTIES		
Tensile Strength, psi (MPa)	65,000 (448)	—
Yield Strength, psi (MPa)	45,000 (310)	—
Elongation, %	15	—

CARBON STEEL BOLTS & NUTS

Shurjoint products utilize oval neck track bolts conforming to ASTM A449 or ASTM A183 Gr. 2 and heavy duty nuts to ASTM A563 Gr. B, available with UNC threads or ISO metric threads. The UNC track bolts and nuts are supplied electro zinc plated in a silver chromate color and ISO metric bolts and nuts in a gold chromate color. Hot-dip galvanized bolts and nuts are also available upon request.

ASTM A449

QUENCHED AND TEMPERED STEEL BOLTS*

CHEMICAL REQUIREMENTS	MINIMUM	MAXIMUM
Carbon, %	0.28	0.55
Manganese, %	0.60	
Phosphorus, %		0.04
Sulfur, %		0.05
PHYSICAL PROPERTIES		
Tensile Strength, psi (MPa)	120,000 (825)	—
Yield Strength, psi (MPa)	92,000 (635)	—
Elongation, %	14	—

*Equivalent to property class 8.8 bolts per ISO 898.

ASTM A183

GRADE 2 CARBON STEEL TRACK BOLTS

CHEMICAL REQUIREMENTS	MINIMUM	MAXIMUM
Carbon, %	0.30	
Phosphorus, %		0.05
Sulfur, %		0.06
PHYSICAL PROPERTIES		
Tensile Strength, psi (MPa)	110,000 (825)	—
Yield Strength, psi (MPa)	80,000 (550)	—
Elongation, %	12	—

ASTM A563

GRADE B CARBON AND ALLOY STEEL HEAVY HEX NUTS

CHEMICAL REQUIREMENTS	MINIMUM	MAXIMUM
Carbon, %		0.55
Phosphorus, %		0.12
Sulfur, %		0.15
PHYSICAL PROPERTIES		
Hardness, Rockwell	B69	C32

SILICON BRONZE NUTS

ASTM B98

ALLOY B COPPER-SILICON ALLOY (UNS NO. C65100)

CHEMICAL REQUIREMENTS	MINIMUM	MAXIMUM
Copper, %	96.0	
Lead, %		0.05
Iron, %		0.8
Zinc, %		1.5
Magnesium, %		0.7
Silicon, %	0.8	2.0
PHYSICAL PROPERTIES		
Tensile Strength, psi (MPa)	55,000 (380)	—
Yield Strength, psi (MPa)	20,000 (140)	—
Elongation, %	11	12

STAINLESS STEEL BOLTS & NUTS

Stainless steel track bolts and nuts, type 304 or type 316, are supplied with Shurjoint stainless steel couplings. Track bolts and nuts are molybdenum disulfide (MoS₂) coated to inhibit galling. As an option, silicon bronze nuts are also available to further reduce the chance of galling.

ASTM A193

GRADE B8 (TYPE 304) STAINLESS STEEL BOLTS

CHEMICAL REQUIREMENTS	MINIMUM	MAXIMUM
Carbon, %		0.08
Manganese, %		2.00
Phosphorus, %		0.045
Sulfur, %		0.03
Silicon, %		1.00
Chromium, %	18.00	20.00
Nickel, %	8.00	10.50
PHYSICAL PROPERTIES		
Tensile Strength, psi (MPa)	75,000 (515)	—
Yield Strength, psi (MPa)	30,000 (205)	—
Elongation, %	30	—

ASTM A193

GRADE B8M (TYPE 316) STAINLESS STEEL BOLTS

CHEMICAL REQUIREMENTS	MINIMUM	MAXIMUM
Carbon, %		0.08
Manganese, %		2.00
Phosphorus, %		0.045
Sulfur, %		0.030
Silicon, %		1.00
Chromium, %	16.00	18.00
Nickel, %	10.00	14.00
Molybdenum, %	2.00	3.00
PHYSICAL PROPERTIES		
Tensile Strength, psi (MPa)	75,000 (515)	—
Yield Strength, psi (MPa)	30,000 (205)	—
Elongation, %	30	—

RECOMMENDED BOLT TORQUE RANGE

Always use factory supplied bolts and nuts for assembly of Shurjoint couplings. Shown below are the general recommended torque ranges for common sizes of carbon steel bolts. Never exceed the recommended torque range by more than 25% as excessive torque can lead to a joint failure, personal injury and or property damage. Always depressurize and drain the piping system before attempting disassembly, adjustment or removal of any piping component. Follow installation instructions for proper assembly of all Shurjoint components.

BOLT SIZE		PROPER TORQUE RANGE	
MM	IN	NM	LB-FT
M10	3/8	40-50	30-40
M12	1/2	120-150	90-110
M16	5/8	140-180	100-130
M20	3/4	200-270	150-200
M22	7/8	240-300	180-220
M24	1	270-340	200-250
M29	1-1/8	250-300	340-400

NOMINAL SIZE	PIPE O.D.	MAX. WORKING PRESSURE (CWP)	MAX. END LOAD (CWP)	AXIAL DISPLACEMENT	ANGULAR MOVEMENT		DIMENSIONS			BOLT SIZE	BOLT TORQUE	WEIGHT
					DEGREE PER COUPLING	PIPE	A	B	C			
in	in	PSI	lb	in	°	ft/in	in	in	in	in	lb-Ft	lb
mm	mm	Bar	kN	in/mm		mm/m	mm	mm	mm		Nm	kg

- 1**
- 2**
- 3**
- 4**
- 5**
- 6**
- 7**
- 8**
- 9**
- 10**

1 NOMINAL SIZE

Shurjoint couplings and fittings are identified by the nominal IPS pipe size in inches, or nominal diameter of pipe (DN) in millimeters. Refer to the chart on the next page which shows a comparison between typical metric and IPS pipe sizes.

2 PIPE O.D.

Actual outside diameter of pipe in inches and millimeters.

3 MAXIMUM WORKING PRESSURE (CWP)

Maximum working pressures listed are CWP (cold water pressure) or maximum allowed working pressure within the service temperature range of the gasket used in the coupling, based on standard wall or sch. 40 steel pipe, cut or roll-grooved to ANSI/AWWA C606 (latest edition) specifications and tested to ASTM F1476. Burst test pressures are minimum 3 times the maximum working pressures unless otherwise specified.

These ratings may occasionally differ from maximum working pressures listed and/or approved by UL, ULC, and/or FM as testing conditions and test pipes differ. For performance data on other pipe schedules contact Shurjoint.

Note: For one time field test only the maximum joint working pressure may be increased 1-1/2 times the figures shown.

4 MAXIMUM END LOAD

Maximum end loads listed are the total of internal and external forces to which the joint can be subjected, based on standard wall or sch. 40 steel pipe, cut or roll-grooved to ANSI/AWWA C606 (latest edition) specifications.

5 AXIAL DISPLACEMENT

Designed range of the gap between pipe ends based on roll-grooved pipe.

6 ANGULAR MOVEMENT (DEFLECTION)

Maximum allowable deflection of pipe from centerline when the joint is used with cut or roll-grooved steel pipe under no internal pressure.

Note: Allowable Axial Displacement and Angular Movement (deflection) figures are for roll-grooved standard steel pipe. Values for cut grooved pipe will be double that of roll-grooved. These values are maximums; for design and installation purposes these figures should be reduced by: 50% for 3/4" /DN20 - 3-1/2" /DN90; 25% for 4" /DN100 and larger to compensate for jobsite conditions.

7 DIMENSIONS

"A", "B", "C" and so on are external dimensions for reference purpose only in inches and millimeters.

8 BOLT SIZE

UNC bolt size and length in inches and ISO metric bolt size and length in millimeters with numbers of bolts where applicable.

9 BOLT TORQUE

Recommended bolt fastening torque in Nm and lb-ft.

10 WEIGHT

Weight of a coupling complete with gasket, bolts and nuts or of a fitting in kilograms and pounds.

NOMINAL SIZE / PIPE O.D.

While Shurjoint fittings are normally identified by the nominal size, always check the actual O.D. of the pipe and fittings to be connected, as in some markets it is customary to refer to different O.D. pipes with the same nominal size.

For example: The nominal size 65 (2-1/2") is referred to 73.0 mm (2.875") pipe O.D. in IPS and 76.1 mm (3.000") pipe O.D. in BS, ISO or JIS pipes. Refer to pipe and tubing standards for details.

PIPE & TUBING STANDARDS

ANSI - American National Standards Institute B36.10 & B36.19

API - American Petroleum Institute API 5L

ASTM - American Society of Testing & Materials A 135, A795 & B88

BS - British Standards BS1387, BS3600, BS3601 & BS3605

ISO - International Standard Organization 65 & 4200

JIS - Japan Industrial Standard G3452 & G3459

Shurjoint product data and technical data are identified by the nominal IPS pipe size in inches or nominal diameter of pipe (DN) in millimeters. The following chart shows a comparison between typical IPS size and metric (DIN) sizes.

NOMINAL SIZE		OUTSIDE DIAMETER (O.D.)								
INCHES (IMPERIAL)	DN (METRIC, MM)	MM (ACTUAL PIPE O.D.)	DIN MM	BS MM	ISO MM	JIS MM	ANSI IN	GB MM	INDIA	
									IS 1239	IS 3589
1/2	15	21.3 mm	DN 15	DN 15	DN 15	21.7 mm	1/2	DN 15	DN 15	—
3/4	20	26.7 mm	26.9 mm	DN 20	DN 20	27.2 mm	3/4	DN 20	DN 20	—
1	25	33.4 mm	33.7 mm	DN 25	DN 25	34.0 mm	1	DN 25	DN 25	—
1-1/4	32	42.2 mm	42.4 mm	DN 32	DN 32	42.7 mm	1-1/4	DN 32	DN 32	—
1-1/2	40	48.3 mm	DN 40	DN 40	DN 40	48.6 mm	1-1/2	DN 40	DN 40	—
2	50	60.3 mm	DN 50	DN 50	DN 50	60.5 mm	2	DN 50	DN 50	—
2-1/2	65	73.1 mm	—	—	—	—	2-1/2	—	—	—
		76.1 mm BS/ISO	76.1 mm	76.1 mm	76.1 mm	76.3 mm	—	76.1 mm**	76.1 mm	—
3	80	88.9 mm	DN 80	DN 80	DN 80	DN 80	3	DN 80	DN 80	—
3-1/2	90	101.6 mm	—	—	—	—	—	—	—	—
4	100	108.0 mm China (& old DIN)	DIN 133.0 mm	—	—	—	—	108.0 mm**	—	—
		114.3 mm	DN 100	DN 100	DN 101	DN 100	4	DN 100	DN 100	—
—	127.0 mm	127.0 mm	—	—	—	—	—	—	—	—
5	125	133.0 mm China	—	—	—	—	—	133.0 mm**	—	—
		139.7 mm BS/ISO	DN 125	139.7 mm	139.7 mm	139.8 mm	—	139.7 mm	139.7 mm	—
		141.3 mm	—	—	—	—	5	—	—	—
—	152.4 mm	152.4 mm	—	—	—	—	—	—	—	—
6	150	159.0 mm China	—	—	—	—	—	159.0 mm	—	—
		165.1 mm JIS/BS	—	165.1 mm	—	165.2 mm	—	—	165.1 mm	—
		168.3 mm	DN 150	—	DN 150	—	6	DN 150	—	DN 150
—	6	193.7 mm	—	—	—	—	—	—	193.7 mm	—
—	203.2 mm	203.2 mm	—	—	—	—	—	—	—	—
8	200	216.3 mm JIS	—	—	—	216.3 mm	—	—	—	—
		219.1 mm	DN 200	DN 200	DN 200	—	8	DN 200	DN 200	DN 200
—	254.0 mm	254.0 mm	—	—	—	—	—	—	—	—
10	250	267.4 mm JIS	—	—	—	267.4 mm	—	—	—	—
		273.0 mm	DN 250	DN 250	DN 250	—	10	DN 250	DN 250	DN 250
—	304.8 mm	304.8 mm	—	—	—	—	—	—	—	—
12	300	318.5 mm JIS	—	—	—	318.5 mm	—	—	—	—
		323.9 mm	DN 300	DN 300	DN 300	—	12	—	—	—
14	350	355.6 mm	DN 350	DN 350	DN 350	DN 350	14	DN 350	—	—
		377.0 mm China	—	—	—	—	—	377.0 mm	—	—
16	400	406.4 mm	DN 400	DN 400	DN 400	DN 400	16	DN 400	—	—
		426.0 mm China	—	—	—	—	—	480.0 mm	—	—
18	450	457.2 mm	DN 450	DN 450	DN 450	DN 450	18	DN 450	—	—
		480.0 mm China	—	—	—	—	—	480.0 mm	—	—
20	500	508.0 mm	DN 500	DN 500	DN 500	DN 500	20	DN 500	—	—
		530.0 mm China	—	—	—	—	—	530.00 mm	—	—
22	550	558.8 mm	—	—	—	DN 550	22	559.0 mm	—	—
		580.00 mm China	—	—	—	—	—	580.0 mm	—	—
24	600	610.0 mm	DN 600	DN 600	DN 600	DN 600	24	DN 600	—	—
		630.0 mm China	—	—	—	—	—	630.0 mm	—	—





















Nominal designations are used where the actual O.D. of the pipe matches the ANSI size.

Otherwise both the nominal and actual O.D. are listed.

China sizes are listed as actual O.D. in mm.

**China sizes are tubing sizes.

Shurjoint production facilities are certified to ISO 9001. Products are designed to conform and meet or exceed all applicable domestic and international standards and are listed, approved and or certified by various approval bodies and registration authorities. Shurjoint is also active in industry and environmental organizations.

 ANSI American National Standards Institute	 FM Factory Mutual Research Corp. Approved for Fire Protection Services	 NYC MEA New York City Department of Buildings, Material & Equipment Services
 ANSI/AWWA American Water Works Association C606 (latest edition)	 FESC Japan Fire Equipment Safety Center	 NYPA New York Power Authority
 ASME American Society of Mechanical Engineers Power Piping, B31.1 Building Services Piping, B31.9	 IAPMO R&T IAPMO Research and Testing, Inc.	 PED Pressure Equipment Directory 97/23/EC
 ASTM American Society of Testing and Materials F 1476-01 Couplings F 1548-01 Fittings F 1155 Shipbuilding	 LLOYD Lloyd's Register Quality Assurance ISO 9001:2008	 UL Underwriter's Laboratories, Inc. - UL213
 CNBOP-PIB Scientific and Research Centre for Fire Protection - National Research Institute	 LPCB Loss Prevention Certification Board LPS-1219	 ULC Underwriter's Laboratories of Canada
 CSA Canadian Standards Association B-242	 NFPA National Fire Protection Association NFPA 13	
 DLEG State of Michigan Board of Mechanical Rules	 NSF NSF/ANSI 61 Drinking Water System Components - Health Effects NSF/ANSI 372 Drinking Water System Components - Lead Content	 UL WATER QUALITY





**grooved mechanical
couplings,
flange adapters &
mechanical tees**

The Shurjoint grooved piping system is one of the most advanced, versatile, economical and reliable systems available today. After the pipe ends are grooved a gasket is mounted over the pipe ends. The coupling segments are then placed over the gasket and the bolts and nuts are fastened resulting in a secure and leak free joint. Shurjoint's quick install couplings are designed to slip over the pipe ends without any dis-assembly making for a quicker joint assembly.

A coupling can be installed faster than a comparable welded or brazed joint, and there is no need for a flame or welding torch on the job site. A grooved mechanical coupling can be installed by fastening a pair of bolts and nuts while using only a wrench or spanner, whereas a comparable flanged joint requires the fastening of many bolts and nuts with a pair of wrenches. The grooved system allows for easy material take-offs and unlike a threaded system, there is no need to allow for added pipe length for thread engagement. With removal of just a few bolts one can easily access the system for cleaning, maintenance, changes and or system expansion.

HELPFUL INFORMATION TO ENSURE PROPER ASSEMBLY

Some couplings and components require the housing bolt pads to make metal-to-metal contact for proper assembly, while others require a specific bolt torque while maintaining equal bolt pad gaps. The icons and information below will help to identify those items to ensure proper assembly. Read and follow all installation instructions for the component being installed.

METAL-TO-METAL CONTACT

Tighten bolts and nuts until bolt pads make metal-to-metal contact. After metal-to-metal contact is achieved, tighten nuts by another one quarter or one half turn to make sure the bolts and nuts are snug and secure. No torque wrench is required. Excessive torque may lead to bolt or joint failure.

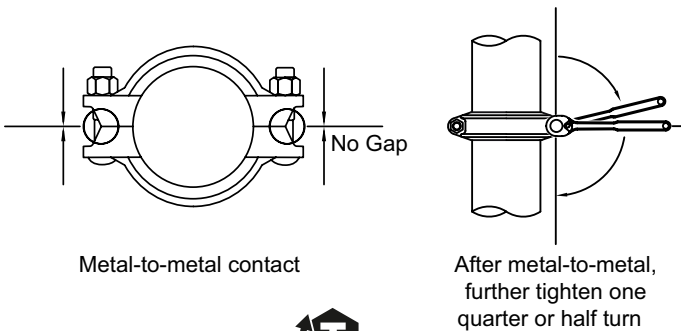

TORQUE REQUIRED

Bolts and nuts must always be tightened to the required torque by using a torque wrench. Normally there will be some gaps seen between the bolt pads after the bolts and nuts are fully tightened. Bolt pad gaps should be equal on both sides of the coupling. Models that require torque tightening include 2" through 4" of model XH-1000, all sizes of models XH-70EP, SS-7X and 79 couplings.

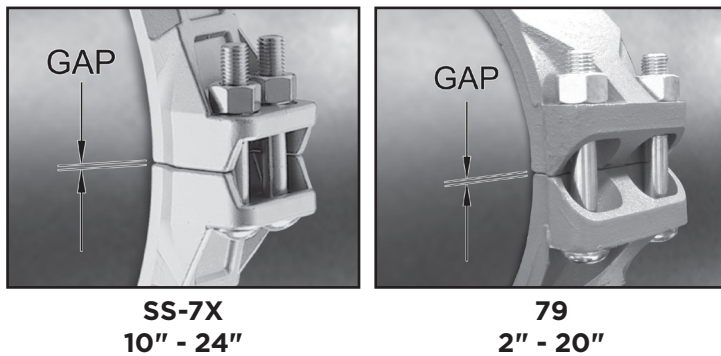

Grooved mechanical couplings are available in both rigid and flexible models. A rigid coupling is used in applications where a rigid joint is desired, similar to that of a traditional flanged, welded, and or threaded connection. To be considered rigid, a coupling would allow less than one degree of deflection of angular movement.

Flexible couplings are designed to accommodate axial displacement, rotation and a minimum one degree of angular movement. Flexible couplings are used in applications that call for curved or deflected layouts and or when systems are exposed to outside forces beyond normal static conditions, such as seismic events or where vibration and or noise attenuation are a concern.

Grooved couplings become less flexible as the pipe size increases. For sizes in excess of 18" (450mm) couplings are very limited in their angular movement. Please refer to the following definition and test methods.

DEFINITION

Grooved couplings are subjected to internal pressures and exterior bending forces during service. ASTM F1476-07 defines a rigid coupling as a joint where there is essentially no available free angular or axial pipe movement and a flexible coupling as a joint wherein there is available limited angular and axial pipe movement.

BENDING MOMENT

Test bending moments are calculated by the equation $M=F(L)$, where F is weight of water filled pipe (Lbs) and L is hanger spacing x 1/2 (feet). The table to the right shows test bending moments calculated using sch. 40 pipe with NFPA 13 hanger spacing.

FLEXIBILITY PROOF TEST

Flexibility proof testing is conducted by applying a small bending moment, 10% of the listed moment, to the test assembly with no internal pressure. A 4" model 7705 or 7707 flexible coupling deflects 3-4 degrees depending on the type of groove processed.

RIGIDITY PROOF TEST

Rigidity proof testing is conducted by applying 25% of the listed moment to the test assembly which is internally pressurized to the rated pressure.

The rigid coupling shall pass the test when the angle has not changed more than angle \emptyset . \emptyset shall be calculated as follows: $\emptyset = 60' (\text{minutes}) - [2' (\text{minutes}) \times (\text{nominal pipe size in inches})]$. In other words, when \emptyset is less than 1 degree (60 minutes), the grooved mechanical coupling is verified as a rigid coupling and when \emptyset is more than 1 degree (60 minutes), the grooved mechanical coupling is regarded as a flexible coupling. The maximum angles \emptyset for rigid couplings are shown in the table to the right.

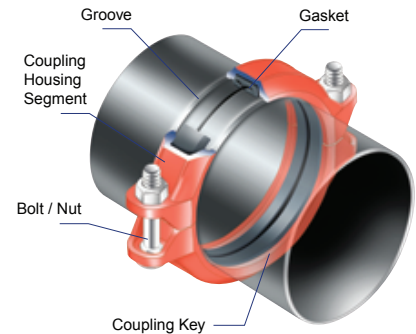

RIGIDITY PROOF TEST ALLOWABLE ANGLE

NOMINAL SIZE (INCHES)	\emptyset , MAX (MINUTES)	\emptyset , MAX (DEGREES)
1-1/2	57	0.95
2	56	0.93
2-1/2	55	0.92
3	54	0.90
4	52	0.87
5	50	0.83
6	48	0.80
8	44	0.73
10	40	0.67
12	36	0.60
14	32	0.53
16	16	0.47

BENDING MOMENT PROOF TEST

The coupling shall resist a 100% listed bending moment while the assembly is internally pressurized to the rated pressure.

BENDING MOMENT PROOF TEST (ASTM F1476)

NOMINAL SIZE (INCHES)	MOMENT NM	MOMENT LB-FT
1-1/2	549	405
2	780	575
2-1/2	1200	885
3	1645	1213
4	2471	1823
5	3551	2619
6	4803	3543
8	7663	5652
10	11379	8393
12	15558	11475
14	18609	13725
16	24299	17922

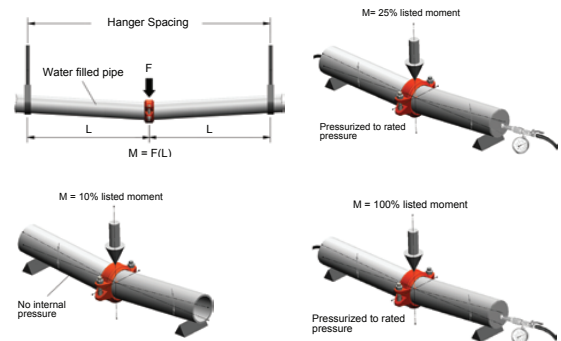

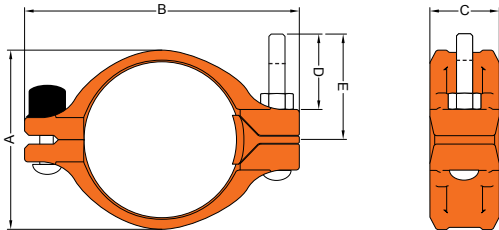

The Shurjoint Model M07 is a ready to install rigid coupling for general piping applications where rigidity is required including valve connections, mechanical rooms, risers and long straight runs. This proprietary design provides a rigid joint that resists flexural and torsional loads. Support and hanging requirements corresponding to ANSI B31.1, B31.9 and NFPA 13.

The Shurjoint Model M07 is available with a proprietary EPDM gasket, which includes a GapSeal and a center leg feature to support the coupling during installation. The M07 includes two identical housing segments and a fully constrained wedge. Proper installation requires the tightening of only one bolt/nut. As this bolt/nut is tightened, the wedge applies uniform compression to the gasket, reducing the chance of pinching. The draw bolt has a break away feature and the hinge bolt/nut is factory pre-set and requires no adjustment.

Patent Pending

DIMENSIONS

NOMINAL SIZE	PIPE O.D.	MAX. WORKING PRESSURE (CWP*)	MAX. END LOAD (CWP)	MAX. END GAP+	DIMENSIONS					BOLT SIZE	WEIGHT
					A	B	C	D	E		
in	in	PSI	lb	in	in	in	in	in	in	in	lb
mm	mm	Bar	kN	mm	mm	mm	mm	mm	mm	mm	kg
2	2.375	750	3340	.25	3.36	5.58	1.90	2.09	2.95	1/2 x 3.8	2.9
50	60.3	52	14.84	6.35	85	142	48	53	75	M12 x 97	1.3
2-1/2	2.875	750	4890	.25	3.80	6.29	1.90	2.09	2.95	1/2 x 3.8	3.3
65	73.0	52	21.75	6.35	97	160	48	53	75	M12 x 97	1.5
3	3.500	750	7250	.25	4.42	7.10	1.90	2.09	2.95	1/2 x 3.8	3.8
80	88.9	52	32.26	6.35	112	180	48	53	75	M12 x 97	1.7
4	4.500	750	11990	.25	5.44	8.35	2.11	1.97	2.91	1/2 x 3.8	5.1
100	114.3	52	53.33	6.35	138	212	54	50	74	M12 x 97	2.3
5	5.563	750	17900	.25	6.73	9.84	2.13	2.17	3.09	5/8 x 4.0	7.7
125	141.3	52	79.66	6.35	171	250	54	55	79	M16 x 102	3.5
6	6.625	700	24000	.25	7.77	10.90	2.11	2.17	3.11	5/8 x 4.0	8.4
150	168.3	48	106.73	6.35	197	277	54	55	79	M16 x 102	3.8
8	8.625	600	35580	.25	10.74	13.79	2.52	2.46	3.43	3/4 x 4.7	17.4
200	219.1	42	158.27	6.35	273	350	64	62	87	M20 x 120	7.9

MATERIAL SPECIFICATIONS

HOUSING:

- Ductile Iron ASTM A536, Gr. 65-45-12, min. tensile strength 65,000 psi (448 MPa).
- ASTM A395 Gr. 65-45-15 (on special request)

SURFACE FINISH:

- Standard Orange Paint Finish.
- Hot dip zinc galvanized (Option).

RUBBER GASKET:

Grade "EHM" EPDM (Color code: Red and Green Stripes)

- Good for cold and hot water up to +250°F (110°C). Also good for services for water with acid, water with chlorine, deionized water, seawater and waste water, dilute acids, oil-free air and many chemicals.
- Not recommended for petroleum oils, minerals oils, solvents and aromatic hydrocarbons.
- Maximum Temperature Range: -30°F (-34°C) to +250°F (+110°C).
- *EPDM gaskets for water services are not recommended for steam services.
- Certified to ANSI/NSF/CAN 61 for cold +73°F/+23°C and hot +180°F/+82°C potable water service.

BOLTS & NUTS:

- Heat treated carbon manganese steel track bolts to ASTM A449-83a (or A183 Gr. 2), minimum tensile strength 110,000 psi (758 MPa), Zinc electroplated, with heavy-duty hexagonal nuts to ASTM A563.
- Standard deep well sockets are required for assembly.

COUPLING SIZES	BOLT SIZE	SOCKET SIZE
2", 2.5", 3", 4"	1/2-13 M12	7/8" 19mm
5", 6"	5/8-11 M16	1-1/16" 24mm
8"	3/4-10 M20	1-1/4" 30mm

PERFORMANCE DATA

The following table show the maximum working pressures (CWP) of Shurjoint Model M07 Coupling used on carbon steel and stainless steel.

CARBON STEEL PIPE

NOMINAL SIZE	CUT-GROOVED		ROLL-GROOVED	
	XS	STD	STD	SCH. 10
in	psi	psi	psi	psi
mm	Bar	Bar	Bar	Bar
2	750	750	750	750
50	52	52	52	52
2-1/2	750	750	750	600
65	52	52	52	42
3	750	750	750	600
80	52	52	52	42
4	750	750	750	600
100	52	52	52	42
5	750	750	750	500
125	52	52	52	35
6	700	700	700	500
150	48	48	48	35
8	600	600	600	300
200	42	42	42	20

STAINLESS STEEL PIPE

NOMINAL SIZE	CUT-GROOVED		ROLL-GROOVED	
	XS	STD	STD	SCH. 10
in	psi	psi	psi	psi
mm	Bar	Bar	Bar	Bar
2	600	600	600	300
50	42	42	42	21
2-1/2	600	600	600	300
65	42	42	42	21
3	600	600	600	300
80	42	42	42	21
4	600	600	600	300
100	42	42	42	21
5	600	600	600	300
125	42	42	42	20
6	600	600	600	300
150	42	42	42	21
8	400	400	400	150
200	28	28	28	10

GENERAL NOTES

- Maximum Working Pressure (CWP) listed is the maximum cold water pressure for general piping services tested to ASTM F1476 and or AWWA C606 methods. Figures listed are based on roll- or cut-grooved standard wall carbon steel pipe. For other pipe schedules or pipe materials, contact Shurjoint for additional information.
- Max. End Load is calculated based on the maximum working pressure (CWP).
- Field Joint Test: For one time only the system may be tested hydrostatically at 1.5 times the maximum working pressure listed (AWWA C606 5.2.3).
- Warning: Piping systems must always be depressurized and drained before attempting disassembly and or removal of any components.
- The 10 Year Limited Warranty applies to manufacturing defects only and does not cover severe service/temperature applications or wear parts.
- Shurjoint reserves the right to change specifications, designs and or standard without notice and without incurring any obligations.

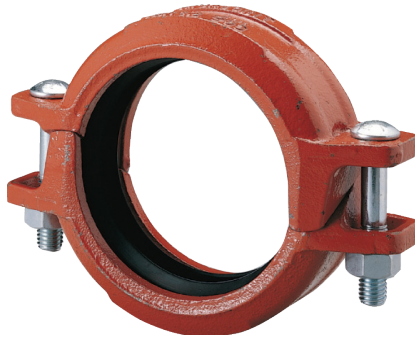

Ensure coupling bolt pads make metal-to-metal contact.

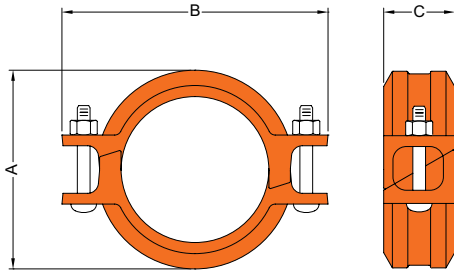

The Shurjoint Model Z07 is an angle-pad design rigid coupling for general piping applications where rigidity is required including valve connections, mechanical rooms, fire mains and long straight runs. The angle-pad design allows the coupling housings to slide along the bolt pads when tightened. The result is an offset clamping action which provides a rigid joint that resists flexural and torsional loads. Support and hanging requirements correspond to ANSI B31.1, B31.9 and NFPA 13.

The Shurjoint Model Z07 is available with a standard "C" shaped or GapSeal gasket in a variety grades to meet your specific service requirements.

For Fire Protection pressure rating, listing, and approval information, refer to Data Sheet B-42 or visit www.shurjoint.com for details or contact Shurjoint.

DIMENSIONS

NOMINAL SIZE	PIPE O.D.	MAX. WORKING PRESSURE (CWP*)	MAX. END LOAD (CWP)	AXIAL DISPLACEMENT †	DIMENSIONS			BOLT		WEIGHT
					A	B	C	NO.	SIZE	
in	in	PSI	lb	in	in	in		in	lb	
mm	mm	Bar	kN	mm	mm	mm		mm	kg	
1-1/4	1.660	750	1620	0-0.05	2.68	4.13	1.85	2	3/8 x 2-1/8	1.6
32	42.2	52	7.27	0-1.2	68	105	47		M10 x 55	0.7
1-1/2	1.900	750	2120	0-0.05	2.91	4.53	1.85	2	3/8 x 2-1/8	2.0
40	48.3	52	9.52	0-1.2	74	115	47		M10 x 55	0.9
2	2.375	750	3320	0-0.07	3.39	4.69	1.88	2	3/8 x 2-3/4	2.4
50	60.3	52	14.84	0-1.7	86	119	48		M10 x 70	1.1
2-1/2	2.875	750	4860	0-0.07	3.94	5.50	1.88	2	3/8 x 2-3/4	2.4
65	73.0	52	21.75	0-1.7	100	140	48		M10 x 70	1.1
3	3.500	750	7210	0-0.07	4.53	6.54	1.88	2	1/2 x 3	3.1
80	88.9	52	32.26	0-1.7	115	166	48		M12 x 75	1.4
4	4.500	750	11920	0-0.16	5.78	8.11	2.13	2	1/2 x 3	4.4
100	114.3	52	53.33	0-4.1	147	206	54		M12 x 75	2.0
5	5.563	750	18220	0-0.16	6.97	9.45	2.09	2	5/8 x 3-1/2	7.5
125	141.3	52	81.50	0-4.1	177	240	53		M16 x 90	3.2
6	6.625	700	24110	0-0.16	8.00	10.67	2.56	2	5/8 x 3-1/2	27.4
150	168.3	48	106.73	0-4.1	203	271	65		M16 x 90	10.4
8	8.625	600	35030	0-0.19	10.55	13.46	2.56	2	7/8 x 6-1/2	26.0
200	219.1	42	158.27	0-4.8	268	342	64		M20 x 120	7.1
10	10.750	500	45350	0-0.13	12.86	15.60	2.56	2	7/8 x 6-1/2	27.4
250	273.0	35	204.77	0-3.2	327	396	65		M20 x 120	10.4
12	12.750	400	51040	0-0.13	14.86	17.80	2.56	2	7/8 x 6-1/2	26.0
300	323.9	28	230.59	0-3.2	377	452	65		M20 x 120	11.8

* Working Pressure is based on roll grooved standard wall carbon steel pipe.

† Allowable Axial Displacement is for roll grooved standard steel pipe. Values for cut grooved pipe will be double that of roll grooved. These values are maximums; for design and installation purposes these figures should be reduced by: 50% for 3/4" - 3-1/2"; 25% for 4" and larger to compensate for jobsite conditions.

MATERIAL SPECIFICATIONS

HOUSING:

- Ductile Iron to ASTM A536, Gr. 65-45-12 and or ASTM A395 Gr.65-45-15, min. tensile strength 65,000 psi (448 MPa).

SURFACE FINISH:

- Standard Orange Paint Finish.
- Hot dipped zinc galvanized (option)

RUBBER GASKET:

Grade "E" EPDM (Color code: Double Green stripe)

- Good for cold & hot water up to +230°F (+110°C). Also good for services for water with acid, water with chlorine, chloramine, deionized water, seawater and waste water, dilute acids, oil-free air and many chemicals.
- Not recommended for petroleum oils, minerals oils, solvents and aromatic hydrocarbons.
- Maximum Temperature Range: -30°F (-34°C) to +230°F (+110°C).
*EPDM gaskets for water services are not recommended for steam services.

(Option) Grade "T" Nitrile (Color code: Orange stripe)

- Recommended for petroleum products, air with oil vapors, vegetable and mineral oils.
- Temperature range: -20°F to +180°F (-29°C to +82°C)
- Do not use for HOT WATER above +150°F (+66°C) or HOT DRY AIR above +140°F (+60°C).

OTHER OPTIONS

Grade "O" - Fluoroelastomer

Grade "L" - Silicone

- For dry systems we recommend the use of the Shurjoint GapSeal gasket.
- For additional details contact Shurjoint.

BOLTS & NUTS:

- Heat treated carbon manganese steel track bolts to ASTM A449-83a (or A183 Gr. 2), minimum tensile strength 110,000 psi (758 MPa), Zinc electroplated, with heavy-duty hexagonal nuts to ASTM A563.

PERFORMANCE DATA

The following tables show the maximum working pressures (CWP) of Shurjoint Model Z07 Standard Rigid Coupling used on both carbon steel and stainless steel pipes. Shurjoint ductile iron couplings can be used in conjunction with stainless steel pipe in non-corrosive environment as the flow media does not come in direct contact with the coupling housings but rather only the gasket.

CARBON STEEL PIPE

NOMINAL SIZE	CUT-GROOVED		ROLL-GROOVED	
	XS	STD	STD	SCH. 10
in	psi	psi	psi	psi
mm	Bar	Bar	Bar	Bar
1-1/4	750	750	750	600
32	52	52	52	42
1-1/2	750	750	750	600
40	52	52	52	42
2	750	750	750	600
50	52	52	52	42
2-1/2	750	750	750	600
65	52	52	52	42
3	750	750	750	600
80	52	52	52	42
4	750	750	750	600
100	52	52	52	42
5	750	750	750	500
125	52	52	52	35
6	700	700	700	400
150	48	48	48	28
8	600	600	600	350
200	42	42	42	24
10	500	500	500	300
250	35	35	35	20
12	400	400	400	250
300	28	28	28	17

STAINLESS STEEL PIPE

NOM. SIZE	CUT-GROOVED		ROLL-GROOVED		
	SCH. 80S	SCH. 40S	SCH. 40S	SCH. 10S	SCH. 5S
in	psi	psi	psi	psi	psi
mm	Bar	Bar	Bar	Bar	Bar
1-1/4	750	750	750	750	300
32	52	52	52	52	20
1-1/2	750	750	750	750	300
40	52	52	52	52	20
2	750	750	750	700	300
50	52	52	52	48	20
2½	750	750	750	700	300
65	52	52	52	48	20
3	750	750	750	500	300
80	52	52	52	35	20
4	750	750	750	500	250
100	52	52	52	34	17
5	750	750	650	500	NR
125	52	52	45	34	NR
6	700	700	600	300	NR
150	48	48	41	20	NR
8	600	600	450	300	NR
200	42	42	31	21	NR
10	500	500	450	150	NR
250	35	35	31	10	NR
12	400	400	400	100	NR
300	28	28	28	7	NR



The Shurjoint Model Z07N is an angle-pad design rigid coupling for general piping applications where rigidity is required including valve connections, mechanical rooms, fire mains and long straight runs. The angle-pad design allows the coupling housings to slide along the bolt pads when tightened. The result is an offset clamping action which provides a rigid joint that resists flexural and torsional loads. Model Z07N is a two-segment coupling which is available in sizes 14"~24". Support and hanging requirements correspond to ANSI B31.1, B31.9 and NFPA 13. All model Z07N are comprised of two identical ductile iron housings segments, EPDM or Nitrile gaskets and plated track bolts and nuts. Housings are supplied with our standard orange paint or hot dipped zinc galvanized.

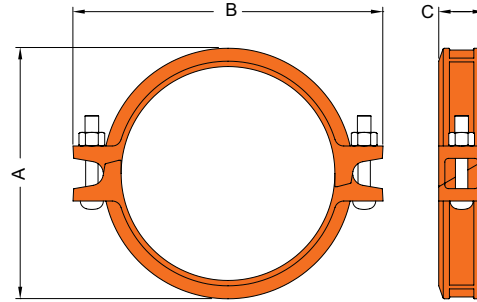
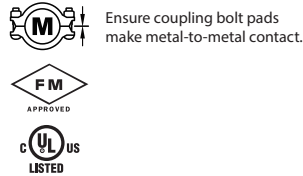

DIMENSIONS

NOMINAL SIZE	PIPE O.D.	MAX. WORKING PRESSURE (CWP*)	MAX. END LOAD (CWP)	AXIAL DISPLACEMENT †	DIMENSIONS			BOLT		WEIGHT
					A	B	C	NO.	SIZE	
in	in	PSI	lb	in	in	in	in		in	lb
mm	mm	Bar	kN	mm	mm	mm	mm		mm	kg
14	14.000	250	38460	0~0.13	16.06	20.00	2.95	2	7/8 x 5-1/2	35.3
350	355.6	17	168.75	0~3.2	408	508	75		-	16.0
16	16.000	250	50240	0~0.13	18.39	22.05	2.95	2	7/8 x 5-1/2	30.5
400	406.4	17	220.41	0~3.2	467	660	75		-	17.9
18	18.000	250	63580	0~0.13	20.68	24.29	3.11	2	7/8 x 5-1/2	40.1
450	457.2	17	278.95	0~3.2	525	617	79		-	22.3
20	20.000	250	78500	0~0.13	22.93	27.99	3.00	2	1 x 5-1/2	57.8
500	508.0	17	344.39	0~3.2	582	711	76		-	26.2
24	24.000	250	113040	0~0.13	27.05	30.55	3.06	2	1 x 5-1/2	70.8
600	609.6	17	495.92	0~3.2	687	776	78		-	32.1

* Working Pressure is based on roll grooved standard wall carbon steel pipe.

† Allowable Axial Displacement and Angular Movement (deflection) figures are for roll grooved standard steel pipe. Values for cut grooved pipe will be double that of roll grooved. These values are maximums; for design and installation purposes these figures should be reduced by: 50% for 3/4" - 3-1/2"; 25% for 4" and larger to compensate for jobsite conditions.

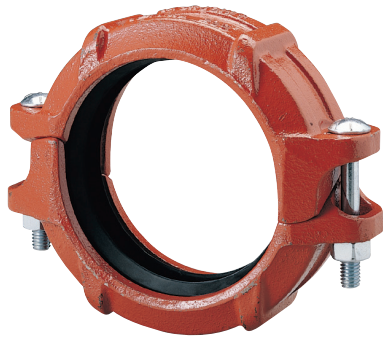

Ensure coupling bolt pads make metal-to-metal contact.

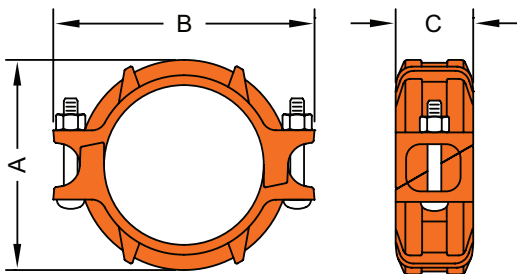

The Shurjoint Model Z05 is an angle-pad design rigid coupling for moderate pressure piping services including fire mains, long straight runs and valve connections. The angle-pad design allows the coupling housings to slide along the bolt pads when tightened. The result is an offset clamping action which provides a rigid joint which resists so called snaking of a long straight run. Support and hanging requirements correspond to ANSI B31.1, B31.9 and NFPA 13. With the removal of only one bolt you can make a fast and easy "swing-over" installation.

For Fire Protection pressure rating, listing, and approval information, refer to Data Sheet B-42 or visit www.shurjoint.com for details or contact Shurjoint.

DIMENSIONS

NOMINAL SIZE	PIPE O.D.	MAX. WORKING PRESSURE (CWP*)	MAX. END LOAD (CWP)	AXIAL DISPLACEMENT †	DIMENSIONS			BOLT		WEIGHT
					A	B	C	NO.	SIZE	
in	in	PSI	lb	in	in	in	in		in	lb
mm	mm	Bar	kN	mm	mm	mm	mm		mm	kg
1-1/4	1.660	500	1080	0-0.05	2.60	4.00	1.81	2	3/8 x 2-1/8	1.41
32	42.2	35	4.89	0-1.2	66	102	46		M10 x 55	0.64
1-1/2	1.900	500	1410	0-0.05	2.83	4.29	1.81	2	3/8 x 2-1/8	1.46
40	48.3	35	6.41	0-1.2	72	109	46		M10 x 55	0.66
2	2.375	500	2210	0-0.07	3.35	4.61	1.85	2	3/8 x 2-3/4	1.74
50	60.3	35	9.99	0-1.7	85	117	47		M10 x 70	0.79
2-1/2	2.875	500	3240	0-0.07	3.86	5.24	1.85	2	3/8 x 2-3/4	2.05
65	73.0	35	14.64	0-1.7	98	133	47		M10 x 70	0.93
3	3.500	500	4800	0-0.07	4.45	5.91	1.88	2	1/2 x 3	2.60
80	88.9	35	21.71	0-1.7	113	150	48		M12 x 75	1.20
4	4.500	500	7940	0-0.16	5.75	7.20	2.13	2	1/2 x 3	4.12
100	114.3	35	35.89	0-4.1	146	183	54		M12 x 75	1.87
5	5.563	350	8500	0-0.16	6.89	9.06	2.13	2	1/2 x 3	5.69
125	141.3	24	37.62	0-4.1	175	230	54		M12 x 75	2.58
6	6.625	350	12050	0-0.16	8.00	10.00	2.09	2	1/2 x 3	6.77
150	168.3	24	53.36	0-4.1	203	254	53		M12 x 75	3.07
8	8.625	350	20430	0-0.19	10.40	12.68	2.52	2	5/8 x 5-5/16	13.38
200	219.1	24	90.44	0-4.8	264	322	64		M15 x 135	6.07

* Working Pressure is based on roll grooved standard wall carbon steel pipe.

† Allowable Axial Displacement and Angular Movement (deflection) figures are for roll grooved standard steel pipe. Values for cut grooved pipe will be double that of roll grooved. These values are maximums; for design and installation purposes these figures should be reduced by: 50% for 3/4" - 3-1/2"; 25% for 4" and larger to compensate for jobsite conditions.

MATERIAL SPECIFICATIONS

HOUSING:

- Ductile Iron to ASTM A536, Gr. 65-45-12 and or ASTM A395, Gr. 65-45-15, min. tensile strength 65,000 psi (448 MPa).

SURFACE FINISH:

- Standard Orange Paint Finish.
- Hot dip zinc galvanized (optional).

RUBBER GASKET:

Grade "Lube-E" (E-A) (Color code: Violet stripe)

- UL approved pre-lubricated gasket designed specifically for the fire protection industry.
- Maximum Temperature Range: Ambient

OTHER OPTIONS

GapSeal E-A* (without prelubrication).

- Maximum Temperature Range: Ambient

BOLTS & NUTS:

- Heat treated carbon manganese steel track bolts to ASTM A449-83a (or A183 Gr. 2), minimum tensile strength 110,000 psi (758 MPa), Zinc electroplated, with heavy-duty hexagonal nuts to ASTM A563.

For dry fire systems, we recommend GapSeal E-A gasket (listed under other options)

For additional details or questions contact Shurjoint.

PERFORMANCE DATA

The following tables show the maximum working pressures (CWP) of Shurjoint Model Z05 Rigid Coupling used on both carbon steel and stainless steel pipes. Shurjoint ductile iron couplings can be used in conjunction with stainless steel pipe in non-corrosive environment as the flow media does not come in direct contact with the coupling housings but rather only the gasket.

CARBON STEEL PIPE

NOM. SIZE	CUT-GROOVED		ROLL-GROOVED	
	XS	STD	STD	SCH. 10
in	psi	psi	psi	psi
mm	Bar	Bar	Bar	Bar
1-1/4	600	600	500	400
32	42	42	35	28
1-1/2	600	600	500	400
40	42	42	35	28
2	600	600	500	400
50	42	42	35	28
2-1/2	600	600	500	400
65	42	42	35	28
3	600	600	500	400
80	42	42	35	28
4	600	600	500	400
100	42	42	35	28
5	450	450	350	300
125	31	31	24	20
6	450	450	350	300
150	31	31	24	20
8	450	450	350	300
200	31	31	24	20

STAINLESS STEEL PIPE

NOM. SIZE	CUT-GROOVED		ROLL-GROOVED		
	SCH. 80S	SCH. 40S	SCH. 40S	SCH. 10S	SCH. 5S
in	psi	psi	psi	psi	psi
mm	Bar	Bar	Bar	Bar	Bar
1-1/4	600	600	450	300	250
32	42	42	31	20	17
1-1/2	600	600	450	300	250
40	42	42	31	20	17
2	600	600	450	300	250
50	42	42	31	20	17
2-1/2	600	600	450	300	250
65	42	42	31	20	17
3	600	600	450	300	250
80	42	42	31	20	17
4	600	600	450	300	200
100	42	42	31	20	14
5	450	450	300	200	NR
125	31	31	20	14	
6	450	450	300	125	NR
150	31	31	20	9	
8	450	450	300	100	NR
200	31	31	20	7	

GENERAL NOTES

- Maximum Working Pressure (CWP) listed is the maximum cold water pressure for general piping services tested to ASTM F1476 and or AWWA C606 methods. Figures listed are based on roll- or cut-grooved standard wall carbon steel pipe. For other pipe schedules or pipe materials, contact Shurjoint for additional information.
- Max. End Load is calculated based on the maximum working pressure (CWP).
- Listed and or Approved Pressures are pressure ratings for fire protection systems, tested and approved by various approval bodies. Please always refer to the latest approval data posted on the Shurjoint website.
- Field Joint Test: For one time only the system may be tested hydrostatically at 1.5 times the maximum working pressure listed (AWWA C606 5.2.3).
- Warning: Piping systems must always be depressurized and drained before attempting disassembly and or removal of any components.
- The 10 Year Limited Warranty applies to manufacturing defects only and does not cover severe service/temperature applications or wear parts.
- Shurjoint reserves the right to change specifications, designs and or standard without notice and without incurring any obligations.

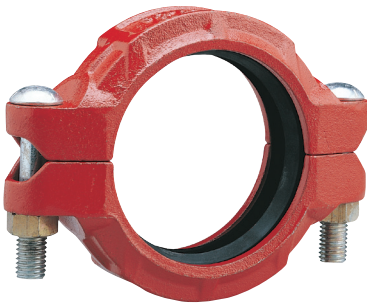

The Model 7707 Flexible Coupling is designed for use in a variety of general piping applications of moderate or high pressure services. Working pressure is usually dictated by the wall thickness and rating of the pipe being used. The Model 7707 couplings feature flexibility that can accommodate misalignment, distortion, thermal stress, vibration and noise and also resist seismic tremors. The utilization of Model 7707 couplings can accommodate a curved layout. See Typical Applications – Flexible Couplings on Shurjoint cutsheet#B-19.

The Model 7707 couplings are comprised of two housing segments, EPDM gaskets and plated track bolts and nuts. Housing segments are supplied with our standard orange paint finish or hot dipped zinc galvanized.



Ensure coupling bolt pads make metal-to-metal contact.

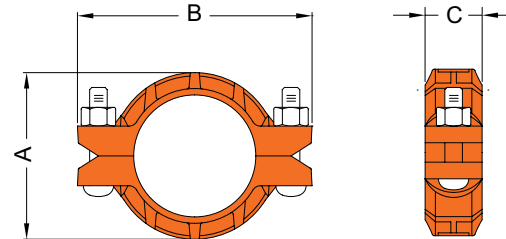

DIMENSIONS

NOMINAL SIZE	PIPE O.D.	MAX. WORKING PRESSURE (CWP*)	MAX. END LOAD (CWP)	AXIAL DISPLACEMENT †	ANGULAR MOVEMENT** †		DIMENSIONS			BOLT SIZE		WEIGHT
					DEGREE PER COUPLING	PER PIPE	A	B	C	NO.	SIZE	
in	in	PSI	lb	in	(°)	in / ft	in	in	in		in	lb
mm	mm	Bar	kN	mm		mm / m	mm	mm	mm		mm	kg
3/4*	1.050	1000	865	0.0625	3° – 23'	0.71	2.13	3.74	1.81	2	3/8 x 2-1/8	1.3
20	26.7	69	3.79	1.6		58	54	95	46		M10x55	0.6
1	1.315	1000	1360	0.0625	2° – 45'	0.58	2.40	4.02	1.81	2	3/8 x 2-1/8	1.7
25	33.4	69	6.15	1.6		48	61	102	46		M10x55	0.8
1-1/4	1.660	1000	2160	0.0625	2° – 10'	0.45	2.76	4.45	1.81	2	1/2 x 3	2.1
32	42.2	69	9.64	1.6		38	70	113	46		M12x75	1.0
1-1/2	1.900	1000	2830	0.0625	1° – 54'	0.40	3.00	4.57	1.81	2	1/2 x 2-3/8	2.1
40	48.3	69	12.64	1.6		33	76	116	46		M12x60	1.0
2	2.375	1000	4430	0.0625	1° – 31'	0.31	3.50	5.35	1.81	2	1/2 x 3	2.6
50	60.3	69	19.69	1.6		26	90	136	46		M12x75	1.2
2-1/2	2.875	1000	6490	0.0625	1° – 15'	0.26	4.00	5.98	1.85	2	1/2 x 3	2.9
65	73.0	69	28.86	1.6		22	102	152	47		M12x75	1.3
3	3.500	1000	9620	0.0625	1° – 02'	0.21	4.88	6.34	1.85	2	1/2 x 3	3.3
80	88.9	69	42.81	1.6		18	124	161	47		M12x75	1.5
4	4.500	1000	15900	0.1250	1° – 36'	0.33	6.18	8.03	2.05	2	5/8 x 3-1/2	4.6
100	114.3	69	70.76	3.2		27	157	204	52		M16x90	2.1
5	5.563	1000	24295	0.1250	1° – 18'	0.27	7.32	9.65	2.09	2	5/8 x 3-1/2	7.2
125	141.3	69	108.14	3.2		22	186	245	53		M16x90	3.3
6	6.625	1000	34455	0.1250	1° – 05'	0.22	8.24	10.75	2.09	2	3/4 x 4-3/4	8.1
150	168.3	69	153.42	3.2		19	214	273	53		M20x120	3.7
8	8.625	800	46720	0.1250	0° – 50'	0.18	10.86	13.23	2.44	2	3/4 x 4-3/4	14.5
200	219.1	55	207.26	3.2		15	276	336	62		M20x120	6.6
10	10.750	800	72575	0.1250	0° – 40'	0.14	13.50	16.10	2.56	2	7/8 x 6-1/2	23.3
250	273.0	55	321.78	3.2		11	343	409	65		---	10.6
12	12.750	800	102090	0.1250	0° – 34'	0.12	15.35	18.50	2.60	2	7/8 x 6-1/2	26.4
300	323.9	55	452.95	3.2		10	390	470	66		---	12.0

* Working Pressure is based on roll grooved standard wall carbon steel pipe.

† Allowable Axial Displacement and Angular Movement (deflection) figures are for roll grooved standard steel pipe. Values for cut grooved pipe will be double that of roll grooved. These values are maximums; for design and installation purposes these figures should be reduced by: 50% for 3/4" – 3-1/2"; 25% for 4" and larger to compensate for jobsite conditions.

** Deflection or angular movement given is the maximum value that a coupling allows. When using the given maximum angles for a curved layout, proper bracing should be used to counter pressure thrust that will occur when the system is pressurized. Flexible couplings can be used for angular movement and/or thermal expansion, though please note individual coupling(s) cannot be used to their maximums for both types of movement within a system at the same time.



The Model 7707N Heavy Duty Flexible Coupling is designed for use in a variety of general piping applications of moderate or high pressure services. The Model 7707N couplings feature flexibility that can deal with misalignment, distortion, thermal stress, vibration and noise and also resist seismic tremors. With the use of Model 7707N couplings you can even design a curved layout. See Typical application – Flexible Couplings on Shurjoint Data Sheet #B-19.

The Model 7707N couplings sizes 14" – 26" (350 mm – 650 mm) are comprised of two identical ductile iron housing segments, an EPDM or Nitrile gaskets and plated track bolts and nuts. Housings are supplied with our standard orange paint or hot dipped zinc galvanized.

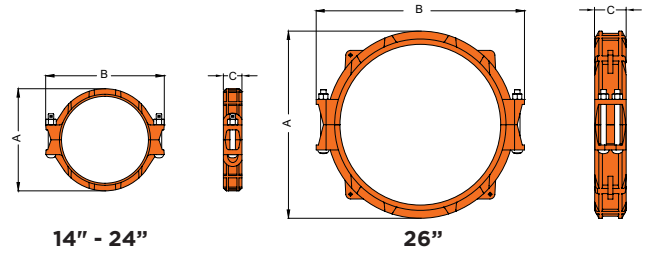
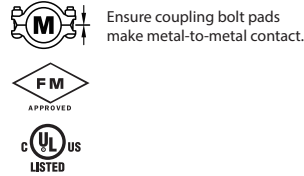

DIMENSIONS

NOMINAL SIZE	PIPE O.D.	MAX. WORKING PRESSURE (CWP)*	MAX. END LOAD (CWP)	AXIAL DISPLACEMENT †	ANGULAR MOVEMENT**†		DIMENSIONS			BOLT		WEIGHT
					DEGREE PER COUPLING	PER PIPE	A	B	C	NO.	SIZE	
in	in	PSI	lb	in	(°)	in / ft	in	in	in		in	lb
mm	mm	Bar	kN	mm		mm / m	mm	mm	mm			kg
14	14.00	300	46150	0.125	0° – 31'	0.06	16.23	19.80	2.95	2	7/8 x 6-1/2	34.5
350	355.6	20	198.53	3.2		4.5	412.0	503.0	75.0			15.7
16	16.00	300	60280	0.125	0° – 27'	0.05	18.23	21.85	2.95	2	1 x 6-1/2	37.0
400	406.4	20	259.30	3.2		4.0	463.0	555.0	75.0			16.8
18	18.00	300	76300	0.125	0° – 24'	0.04	20.45	24.06	3.11	2	1 x 6-1/2	47.1
450	457.2	20	327.89	3.2		3.5	520.0	611.0	79.0			22.3
20	20.00	300	94200	0.125	0° – 22'	0.04	22.48	26.38	3.11	2	1 x 6-1/2	54.4
500	508.0	20	405.16	3.2		3.0	571.0	670.0	79.0			24.7
22	22.00	300	113980	0.125	0° – 19'	0.04	24.46	30.16	3.11	2	1-1/8 x 6-1/2	63.0
550	558.8	20	490.60	3.2		3.0	621.4	766.0	79.0			28.6
24	24.00	300	135640	0.125	0° – 18'	0.03	26.55	30.43	3.11	2	1-1/8 x 6-1/2	65.1
600	609.6	20	584.20	3.2		2.5	674.0	773.0	79.0			29.5
26	26.00	300	159190	0.125	0° – 17'	0.03	29.68	33.15	4.94	4	7/8 x 9-5/8	143.0
650	660.4	20	684.72	3.2		2.5	754.0	842.0	125.6			65.0

* Working pressure is based on roll-grooved standard wall carbon steel pipe.

† Allowable Axial Displacement and Angular Movement (deflection) figures are for roll grooved standard steel pipe. Values for cut grooved pipe will be double that of roll grooved. These values are maximums; for design and installation purposes these figures should be reduced by: 50% for 3/4" - 3-1/2"; 25% for 4" and larger to compensate for jobsite conditions.

** Deflection or angular movement given is the maximum value that a coupling allows. When using the given maximum angles for a curved layout, proper bracing should be used to counter pressure thrust that will occur when the system is pressurized. Flexible couplings can be used for angular movement and or thermal expansion, though please note individual coupling(s) cannot be used to their maximums for both types of movement within a system at the same time.



The Shurjoint Model 7707L Large diameter couplings in sizes 28" -42" / 700 mm – 1050 mm are designed for joining large diameter IPS pipe that can be roll grooved, or used with type A, D, or E rings. All couplings feature a six to eight segment design, incorporating two bolts at each segment joint to ensure a positive connection and seal. All Model 7707L couplings are comprised of two identical ductile iron housings segments, EPDM or Nitrile rubber gasket and plated track bolts & nuts. Housings segments are supplied with our standard orange paint finish or hot dipped zinc galvanized.

 Ensure coupling bolt pads make metal-to-metal contact.

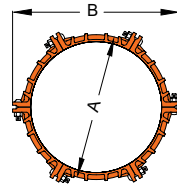

28" - 36"

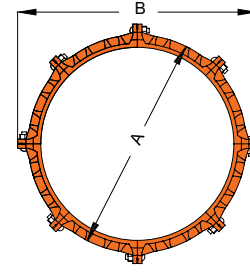
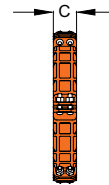

40" - 42"

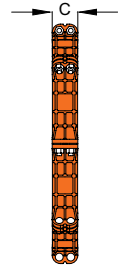

DIMENSIONS

NOMINAL SIZE	PIPE O.D.	MAX. WORKING PRESSURE (CWP)*	MAX. END LOAD (CWP)	AXIAL DISPLACEMENT †	ANGULAR MOVEMENT**†		DIMENSIONS			BOLT		WEIGHT
					DEGREE PER COUPLING	PER PIPE	A	B	C	NO.	SIZE	
in	in	PSI	lb	in	(°)	in / ft	in	in	in		in	lb
mm	mm	Bar	kN	mm		mm / m	mm	mm	mm			kg
28	28.0	175	107700	0.250	---	---	32.0	35.98	5.0	12	7/8 x 4	180
700	711.2	12	476.47	6.4	---	---	813	914	127			82
30	30.0	175	123630	0.250	---	---	34.0	38.07	5.0	12	7/8 x 4	209
750	762.0	12	546.97	6.4	---	---	864	967	127			95
32	32.0	175	140670	0.250	---	---	36.0	40.08	5.0	12	7/8 x 4	207
800	812.8	12	622.33	6.4	---	---	914	1018	127			94
34	34.0	175	158800	0.250	---	---	38.3	42.00	5.0	12	7/8 x 4	198
850	863.6	12	702.55	6.4	---	---	974	1066	127			90
36	36.0	175	178030	0.250	---	---	40.0	44.02	5.0	12	7/8 x 4	212
900	914.4	12	787.63	6.4	---	---	1016	1118	127			96
40	40.0	175	219800	0.250	---	---	43.5	49.49	5.4	16	1 x 3-1/2	271
1000	1016.0	12	972.39	6.4	---	---	1105	1257	138			123
42	42.0	175	242330	0.250	---	---	45.5	51.57	5.4	16	1 x 3-1/2	313
1050	1066.8	12	1072.05	6.4	---	---	1156	1310	138			142

* Working pressure is based on roll-grooved standard wall carbon steel pipe.

† Allowable Axial Displacement and Angular Movement (deflection) figures are for roll grooved standard steel pipe. Values for cut grooved pipe will be double that of roll grooved. These values are maximums; for design and installation purposes these figures should be reduced by: 50% for 3/4" - 3-1/2"; 25% for 4" and larger to compensate for jobsite conditions.

** Deflection or angular movement given is the maximum value that a coupling allows. When using the given maximum angles for a curved layout, proper bracing should be used to counter pressure thrust that will occur when the system is pressurized. Flexible couplings can be used for angular movement and or thermal expansion, though please note individual coupling(s) cannot be used to their maximums for both types of movement within a system at the same time.

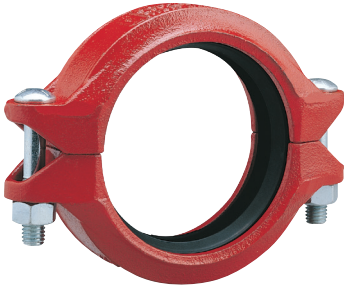

The Model 7705 Standard Flexible Coupling is a standard flexible coupling for use in a variety of general piping applications of moderate pressure services. The model 7705 couplings features flexibility that can deal with misalignment, distortion, thermal stress, vibration and noise and also resist seismic tremors. With the use of Model 7705 couplings you can even design a curved layout. See Typical Applications – Flexible Couplings on Shurjoint cut sheet #B-19.

All Model 7705 couplings are comprised of two identical ductile iron housings segments, EPDM or Nitrile rubber gasket and plated track bolts & nuts. Housings segments are supplied with our standard orange paint finish or hot dipped zinc galvanized.



Ensure coupling bolt pads make metal-to-metal contact.

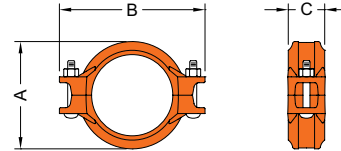

DIMENSIONS

NOMINAL SIZE	PIPE O.D.	MAX. WORKING PRESSURE (CWP*)	MAX. END LOAD (CWP)	AXIAL DISPLACEMENT †	ANGULAR MOVEMENT** †		DIMENSIONS			BOLT SIZE	WEIGHT
					DEGREE PER COUPLING	PER PIPE	A	B	C		
in	in	PSI	lb	in		in/ft	in	in	in	in	lb
mm	mm	Bar	kN	mm	(°)	mm/m	mm	mm	mm	mm	kg
1	1.315	500	670	0.0625	2° - 45'	0.58	2.24	3.94	1.81	3/8 x 1-3/4	1.3
25	33.4	35	3.12	1.6		48	57	100	46	M10 x 45	0.6
1-1/4	1.660	500	1080	0.0625	2° - 10'	0.46	2.60	4.06	1.81	3/8 x 2-1/8	1.5
32	42.2	35	4.94	1.6		38	66	103	46	M10 x 55	0.7
1-1/2	1.900	500	1410	0.0625	1° - 54'	0.4	2.83	4.25	1.81	3/8 x 2-1/8	1.6
40	48.3	35	6.41	1.6		33	72	108	46	M10 x 55	0.7
2	2.375	500	2210	0.0625	1° - 31'	0.32	3.31	5.08	1.85	3/8 x 2-1/8	1.8
50	60.3	35	9.99	1.6		27	84	129	47	M10 x 55	0.8
2-1/2	2.875	500	3240	0.0625	1° - 15'	0.26	3.90	5.59	1.85	3/8 x 2-1/8	2.0
65	73.0	35	14.64	1.6		22	99	142	47	M10 x 55	0.9
3	3.500	500	4800	0.0625	1° - 02'	0.22	4.57	6.46	1.85	1/2 x 3	2.8
80	88.9	35	21.71	1.6		18	116	164	47	M12 x 75	1.3
4	4.500	500	7940	0.1250	1° - 36'	0.34	5.71	7.76	2.05	1/2 x 3	4.1
100	114.3	35	35.89	3.2		28	145	197	52	M12 x 75	1.9
5	5.563	450	10930	0.1250	1° - 18'	0.27	6.77	9.17	2.05	5/8 x 3-1/2	5.9
125	141.3	31	48.59	3.2		23	172	233	52	M16 x 90	2.7
6	6.625	450	15500	0.1250	1° - 05'	0.23	7.87	10.55	2.09	5/8 x 3-1/2	7.0
150	168.3	31	68.93	3.2		19	200	268	53	M16 x 90	3.2
8	8.625	300	17510	0.1250	0° - 50'	0.18	10.24	13.27	2.44	5/8 x 3-1/2	12.8
200	219.1	20	75.37	3.2		15	260	337	62	M16 x 90	5.8
10	10.750	300	27210	0.1250	0° - 40'	0.14	13.50	13.78	2.56	3/4 x 4-3/4	18.0
250	273.0	20	117.01	3.2		12	343	350	65	M20 x 120	8.2
12	12.750	300	38280	0.1250	0° - 34'	0.12	15.35	15.75	2.56	7/8 x 6-1/2	23.8
300	323.9	20	164.71	3.2		10	390	400	65	---	10.8

All DIN size 7705 couplings up to DN150 size and the DN200 7705H coupling are VdS approved in addition to cULus and FM approvals.

* Working Pressure is based on roll grooved standard wall carbon steel pipe.

† Allowable Axial Displacement and Angular Movement (deflection) figures are for roll grooved standard steel pipe. Values for cut grooved pipe will be double that of roll grooved. These values are maximums; for design and installation purposes these figures should be reduced by: 50% for 3/4" - 3-1/2"; 25% for 4"/DN100 and larger to compensate for jobsite conditions.

** Deflection or angular movement given is the maximum value that a coupling allows. When using the given maximum angles for a curved layout, proper bracing should be used to counter pressure thrust that will occur when the system is pressurized. Flexible couplings can be used for angular movement and or thermal expansion, though please note individual coupling(s) cannot be used to their maximums for both types of movement within a system at the same time.

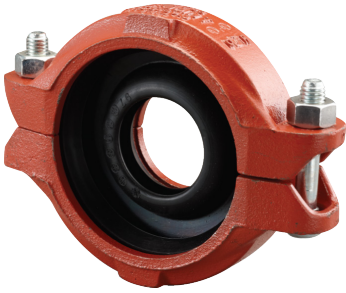

The Model 7706 Reducing Coupling allows direct reduction on a piping run and eliminates the need for a concentric reducer and couplings. The specially designed rubber gasket prevents the smaller pipe from telescoping into the larger pipe during vertical installation. All 7706 couplings are comprised of two identical housing segments, EPDM or Nitrile gaskets and plated track bolts and nuts. Housings are supplied with our standard orange paint or hot dipped zinc galvanized.

Caution: The Model 7706 couplings must not be used with an end cap, as the end cap could be sucked into the pipe by the vacuum created when a system is being drained.



The Model 7706 couplings must not be used with an end cap, as the end cap could be sucked into the pipe by the vacuum created when a system is being drained.



Ensure coupling bolt pads make metal-to-metal contact.

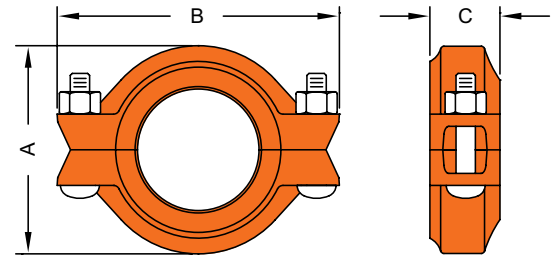

DIMENSIONS

NOMINAL SIZE	PIPE O.D.	MAX. WORKING PRESSURE (CWP)*	MAX. END LOAD (CWP)	AXIAL DISPLACEMENT †	ANGULAR MOVEMENT**†		DIMENSIONS			BOLT SIZE	WEIGHT
					DEGREE PER COUPLING	PER PIPE	A	B	C		
in mm	in mm	PSI Bar	lb kN	in mm	(°)	in / ft mm / m	in mm	in mm	in mm	in mm	lb kg
1-1/2 x 1-1/4 40 x 32	1.900 x 1.660 48.3 x 42.2	500 35	1410 6.23	0 ~ 0.065 0 ~ 1.6	1° - 54'	0.20 17	2.83 72	4.65 118	1.81 46	3/8 x 2-1/2 M10 x 55	1.8 0.8
2 x 1-1/2 50 x 40	2.375 x 1.900 60.3 x 48.3	500 35	2210 9.70	0 ~ 0.065 0 ~ 1.6	1° - 31'	0.16 13	3.35 85	4.80 122	1.89 48	3/8 x 2-1/8 M10 x 55	2.0 0.9
2-1/2 x 2 65 x 50	2.875 x 2.375 73.0 x 60.3	500 35	3240 14.22	0 ~ 0.065 0 ~ 1.6	1° - 15'	0.13 11	3.78 96	5.67 144	1.89 48	3/8 x 2-1/8 M10 x 55	2.6 1.2
3 x 2 80 x 50	3.500 x 2.375 88.9 x 60.3	50 35	4800 21.09	0 ~ 0.065 0 ~ 1.6	1° - 02'	0.11 9	4.57 116	6.61 168	1.89 48	1/2 x 3 M12 x 75	3.3 1.5
3 x 2-1/2 80 x 65	3.500 x 2.875 88.9 x 73.0	500 35	4800 21.09	0 ~ 0.065 0 ~ 1.6	1° - 02'	0.11 9	4.57 116	6.61 168	1.89 48	1/2 x 3 M12 x 75	3.7 1.7
4 x 2 100 x 50	4.500 x 2.375 114.3 x 60.3	500 35	7940 34.87	0 ~ 0.095 0 ~ 2.4	1° - 12'	0.13 11	5.75 146	7.80 198	1.93 49	1/2 x 3 M12 x 75	5.3 2.4
4 x 2-1/2 100 x 65	4.500 x 2.875 114.3 x 73.0	500 35	7940 34.87	0 ~ 0.095 0 ~ 2.4	1° - 12'	0.13 11	5.75 146	7.80 198	1.93 49	1/2 x 3 M12 x 75	5.7 2.6
4 x 3 100 x 80	4.500 x 3.500 114.3 x 88.9	500 35	7940 34.87	0 ~ 0.095 0 ~ 2.4	1° - 12'	0.13 11	5.75 146	7.80 198	2.01 51	1/2 x 3 M12 x 75	5.3 2.4
5 x 4 125 x 100	5.563 x 4.500 141.3 x 114.3	400 28	9710 43.88	0 ~ 0.125 0 ~ 3.2	1° - 18'	0.14 12	6.30 160	9.84 242	2.01 51	5/8 x 3-1/2 M16 x 90	7.9 3.6
6 x 3 150 x 80	6.625 x 3.500 168.3 x 88.9	400 28	13780 62.26	0 ~ 0.125 0 ~ 3.2	1° - 06'	0.12 10	8.19 208	10.63 270	2.05 52	5/8 x 3-1/2 M16 x 90	10.1 4.6
6 x 4 150 x 100	6.625 x 4.500 168.3 x 114.3	400 28	13780 62.26	0 ~ 0.125 0 ~ 3.2	1° - 06'	0.12 10	8.19 208	10.63 270	2.05 52	5/8 x 3-1/2 M16 x 90	9.9 4.5
8 x 6 200 x 150	8.625 x 6.625 219.1 x 168.3	400 28	23350 105.51	0 ~ 0.125 0 ~ 3.2	0° - 50'	0.09 8	10.24 260	13.11 333	2.09 53	3/4 x 4-3/4 M20 x 120	14.3 6.5

* Working Pressure is based on roll- or cut-grooved standard wall carbon steel pipe.

† Allowable Axial Displacement and Angular Movement (deflection) figures are for roll grooved standard steel pipe. Values for cut grooved pipe will be double that of roll grooved. These values are maximums; for design and installation purposes these figures should be reduced by: 50% for 3/4" - 3-1/2"; 25% for 4" and larger to compensate for jobsite conditions.

** Deflection or angular movement given is the maximum value that a coupling allows. When using the given maximum angles for a curved layout, proper bracing should be used to counter pressure thrust that will occur when the system is pressurized. Flexible couplings can be used for angular movement and or thermal expansion, though please note individual coupling(s) cannot be used to their maximums for both types of movement within a system at the same time.



The Shurjoint Model XH-70EP coupling is an extra heavy rigid coupling for use with plastic coated pipe, cement-lined pipe or Sch. 40S or 80S stainless steel pipe. The coupling is capable of holding high pressure up to 2,500 psi (175 Bar) depending on pipe size when used in conjunction with machined EP cut-grooves and the applicable pipe. The coupling housings are painted black and supplied with an EP (End-Protection) gasket, which will permit a continuous connection of lined-surface of the pipe and also protect the pipe ends from corrosion. The standard EP gaskets are made of oil-resistant Nitrile compound.

XH-70EP couplings are not allowed to install on standard or commercial roll- or cut- grooved pipes. Pipe ends shall always be prepared with the EP Cut-Grooves.

Always use the XH-70EP coupling with an EP (End-Protection) gasket. Do not use a C-shaped standard gasket with a XH-70EP coupling.



Always fasten the bolts to the required torque.

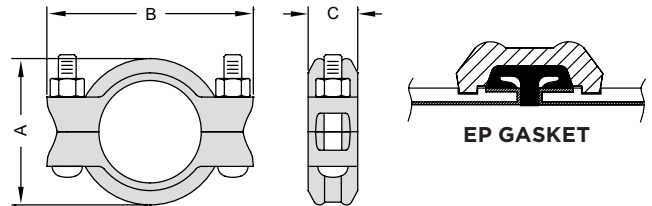

DIMENSIONS

NOMINAL SIZE	PIPE O.D.	MAX. WORKING PRESSURE (CWP*)	MAX. END LOAD (CWP)	AXIAL DISPLACEMENT †	DIMENSIONS			BOLT		WEIGHT	
					A	B	C	NO.	SIZE	Lbs	Kgs
in	in	Psi	Lbs	in	in	in		in	Lbs-Ft	Lbs	
mm	mm	Bar	kN	mm	mm	mm				Nm	Kgs
2	2.375	2500	11070	3.54	5.71	1.92	2	x 2¾	60 - 90	3.3	
50	60.3	175	50.0	90	145	49				80 - 120	1.5
2-½	2.875	2500	16220	4.06	6.61	1.92	2	x 2¾	60 - 90	4.0	
65	73.0	175	73.2	103	168	49				80 - 120	1.8
3	3.500	2500	24040	4.80	7.40	2	2	x 2¾	60 - 90	4.8	
80	88.9	175	108.6	122	188	51				80 - 120	2.2
4	4.500	2500	39740	6.18	8.74	2.17	2			8.8	
100	114.3	175	179.5	157	222	55		¾ x 4¾	74 - 170	100 - 235	4.0
6	6.625	2000	68910	8.58	11.61	2.25	2			17.6	
150	168.3	140	311.3	218	295	57		x 5½	125 - 200	170 - 275	8.0
8	8.625	2000	116790	10.83	14.33	2.75	2			24.0	
200	219.1	140	527.6	275	364	70		1 x 5½	200 - 300	275 - 400	10.9
10	10.750	1250	113400	13.15	16.70	2.95	2			31.2	
250	273.0	88	514.8	334	424	75		1 x 5½	200 - 300	275 - 400	14.2
12	12.750	1250	159510	15.35	18.90	2.95	2			36.7	
300	323.9	88	724.7	390	480	75		1 x 5½	200 - 300	275 - 400	16.7

* Working pressure is based on EP cut grooved XS, Sch. 80 pipe. Compensate for jobsite conditions.

“EP” END PROTECTION CUT GROOVING DIMENSIONS FOR XH-70EP COUPLINGS

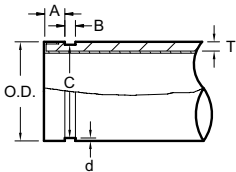

- EP cut-grooves are for plastic coated or cement lined pipe to be connected with Shurjoint XH-70EP couplings only. Do not roll groove pipe, which can damage the coating or lining and or create flared pipe ends.
- Always use plain-end square cut pipe. Do not use beveled end pipe.
- Always use an EP gasket with a XH-70EP coupling. Do not use a standard gasket.
- The gasket seating area shall be free from deep scores, marks, or ridges that could prevent a positive seal.

NOMINAL SIZE	PIPE O.D.			A		B		C		D GROOVE DEPTH (REF.)	T MIN. ALLOWED WALL THICKNESS
	BASIC	TOLERANCE		GASKET SEAT		GROOVE WIDTH		GROOVE DIA.			
		+	-	BASIC	TOL. ±	BASIC	TOL. +0.010/+0.25	BASIC	TOL. +0/+0		
in	in	in	in	in	in	in	in	in	in	in	in
mm	mm	mm	mm	mm	mm	mm	mm	mm	mm	mm	mm
2	2.375	+0.024	-0.024	0.562	±0.010	0.255	-0.005	2.250	-0.015	0.063	0.154
50	60.3	+0.61	-0.61	14.27	±0.25	6.48	-0.13	57.15	-0.38	1.60	3.91
2-1/2	2.875	+0.029	-0.029	0.562	±0.010	0.255	-0.005	2.720	-0.018	0.078	0.188
65	73.0	+0.74	-0.74	14.27	±0.25	6.48	-0.13	69.09	-0.46	1.98	4.78
3	3.500	+0.035	-0.031	0.562	±0.010	0.255	-0.005	3.344	-0.018	0.078	0.188
80	88.9	+0.89	-0.79	14.27	±0.25	6.48	-0.13	84.94	-0.46	1.98	4.78
4	4.500	+0.045	-0.031	0.605	±0.015	0.305	-0.005	4.334	-0.020	0.083	0.203
100	114.3	+1.14	-0.79	15.37	±0.38	7.75	-0.13	110.08	-0.51	2.11	5.16
6	6.625	+0.063	-0.031	0.605	±0.015	0.305	-0.005	6.455	-0.022	0.085	0.219
150	168.3	+1.60	-0.79	15.37	±0.38	7.75	-0.13	163.96	-0.56	2.16	5.56
8	8.625	+0.063	-0.031	0.714	±0.015	0.400	-0.010	8.441	-0.025	0.092	0.238
200	219.1	+1.60	-0.79	18.14	±0.38	10.16	-0.25	214.40	-0.64	2.34	6.05
10	10.750	+0.063	-0.031	0.714	±0.015	0.400	-0.010	10.562	-0.027	0.094	0.250
250	273.0	+1.60	-0.79	18.14	±0.38	10.16	-0.25	268.28	-0.69	2.39	6.35
12	12.750	+0.063	-0.031	0.714	±0.015	0.400	-0.010	12.531	-0.030	0.109	0.279
300	323.9	+1.60	-0.79	18.14	±0.38	10.16	-0.25	318.29	-0.76	2.77	7.09

1. EP cut-grooves are for plastic coated or cement lined pipe to be connected with Shurjoint XH-70EP couplings only. Any coating applied to the gasket seat (A) and gasket width (B) should not exceed 0.25mm (0.010") thick. Do not roll groove pipe, which can damage the coating or lining and or create flared pipe ends.
2. Always use plain-end square cut pipe. Do not use beveled end pipe.
3. Always use an EP gasket with a XH-70EP coupling. Do not use a standard gasket.
4. The gasket seating area shall be free from deep scores, marks, or ridges that could prevent a positive seal.

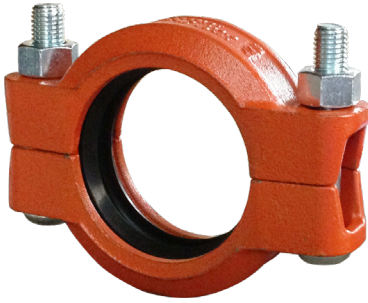

The Shurjoint Model XH-1000 is an extra heavy rigid coupling designed for high pressure services up to 1000 psi (70 Bar). This coupling is painted orange and is supplied with a standard EPDM or Nitrile C-shaped gasket and heavy duty bolts and nuts. The Model XH-1000 can be installed on standard roll or cut grooved pipes or components. Sizes 2" through 4" require a bolt torque of 60-70 lb-ft with some bolt gaps. For sizes 6" and above, the bolt pads will make metal to metal contact when properly installed with no torque wrench required.



Sizes 6" through 12" are designed to make a metal-to-metal contact when properly installed.

Sizes 2" through 4" require a bolt torque of 60 - 70 lb-ft (80 - 95 Nm). Normally you can see some gaps between the bolt pads. Bolt pad gaps should be equal on both sides of the coupling.

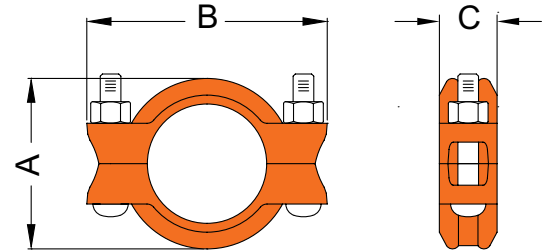

DIMENSIONS

NOMINAL SIZE	PIPE O.D.	MAX. WORKING PRESSURE (CWP*)	MAX. END LOAD (CWP)	AXIAL DISPLACEMENT †	DIMENSIONS			BOLT		WEIGHT
					A	B	C	NO.	SIZE	
in	in	PSI	lb	in	in	in	in		in	lb
mm	mm	Bar	kN	mm	mm	mm	mm			kg
2	2.375	1000	4420	0~0.14	3.50	5.71	1.92	2	5/8 x 2-3/4	3.4
50	60.3	69	19.98	0~3.6	90	145	49			1.6
2-1/2	2.875	1000	6480	0~0.14	4.02	6.61	1.92	2	5/8 x 2-3/4	3.8
65	73.0	69	29.28	0~3.6	102	168	49			1.7
3	3.500	1000	9610	0~0.14	4.86	7.40	1.92	2	5/8 x 2-3/4	4.8
80	88.9	69	43.43	0~3.6	123	188	49			2.2
4	4.500	1000	15890	0~0.25	6.09	8.74	2.10	2	3/4 x 4-3/4	8.4
100	114.3	69	71.79	0~6.4	155	222	53			3.8
6	6.625	1000	34450	0~0.25	8.58	11.61	2.25	2	7/8 x 5-1/8	17.6
150	168.3	69	155.65	0~6.4	218	295	57			8.0
8	8.625	800	46710	0~0.25	10.83	14.33	2.75	2	1 x 5-1/2	24.0
200	219.1	55	207.26	0~6.4	275	364	70			10.9
10	10.750	800	72570	0~0.25	13.15	16.70	2.95	2	1 x 5-1/2	31.2
250	273.0	55	321.78	0~6.4	334	424	70			14.2
12	12.750	800	102080	0~0.25	15.35	18.90	2.95	2	1 x 5-1/2	36.7
300	323.9	55	452.95	0~6.4	390	480	70			16.7

* Working Pressure is based on roll grooved standard wall carbon steel pipe. Stated pressure ratings have been developed with a safety factor.

Please see Shurjoint's 2017 online installation instructions for most recently updated instructions. Proper installation is important to proper performance.

† Allowable Axial Displacement and Angular Movement (deflection) figures are for roll grooved standard steel pipe. Values for cut grooved pipe will be double that of roll grooved. These values are maximums; for design and installation purposes these figures should be reduced by: 50% for 3/4" - 3-1/2"; 25% for 4" and larger to compensate for jobsite conditions.



The Model G28 Hinged Grooved Coupling is designed for quick connect and disconnect services. The housing segments are hinged with a lever handle for easy assembly. The use of the split pin can secure and prevent the accidental opening of the coupling.

The Model G28 can be used in a wide variety of applications with standard rolled or cut grooved pipe. Housings 1-1/2" - 4" (40 mm - 100 mm) feature a smooth outer surface, housings 5" - 10" (125 mm - 250 mm) feature a cross-ribbed design for added strength.

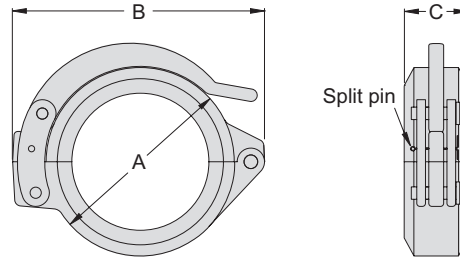

DIMENSIONS

NOMINAL SIZE	PIPE O.D.	MAX. WORKING PRESSURE (CWP)**	MAX. END LOAD (CWP)	AXIAL DISPLACEMENT †	ANGULAR MOVEMENT / DEFLECTION**†	DIMENSIONS			WEIGHT
						A	B	C	
in	in	PSI	lb	in	(°)	in	in	in	lb
mm	mm	Bar	kN	mm		mm	mm	mm	kg
1-1/2	1.900	300	850	0 - 0.06	1° - 54'	2.95	4.65	1.85	2.2
40	48.3	20	3.66	0 - 1.6		75	118	47	1.0
2	2.375	300	1320	0 - 0.06	1° - 45'	3.43	5.08	1.85	2.4
50	60.3	20	5.71	0 - 1.6		87	129	47	1.1
2-1/2	2.875	300	1940	0 - 0.06	1° - 15'	3.94	5.63	1.85	3.1
65	73.0	20	8.37	0 - 1.6		100	143	47	1.4
3	3.500	300	2880	0 - 0.06	1° - 12'	4.69	6.46	1.85	4.0
80	88.9	20	12.41	0 - 1.6		119	164	47	1.7
4	4.500	300	4760	0 - 0.13	1° - 36'	5.98	7.95	2.05	5.9
100	114.3	20	20.51	0 - 3.2		152	202	52	2.7
5	5.563	300	7280	0 - 0.13	1° - 18'	7.05	10.00	2.05	10.8
125	141.3	20	31.35	0 - 3.2		179	254	52	4.9
6	6.625	300	10330	0 - 0.13	1° - 05'	8.11	11.02	2.05	13.2
150	168.3	20	44.47	0 - 3.2		206	280	52	6.0
8	8.625	300	17510	0 - 0.13	0° - 50'	10.08	13.58	2.44	15.2
200	219.1	20	75.37	0 - 3.2		256	345	62	6.9
10	10.750	300	27210	0 - 0.13	0° - 40'	12.68	17.48	2.60	36.1
250	273.0	20	117.01	0 - 3.2		322	444	66	16.4

* Working pressure is based on roll grooved standard wall carbon steel pipe.

† Allowable Axial Displacement and Angular Movement (deflection) figures are for roll grooved standard steel pipe. Values for cut grooved pipe will be double that of roll grooved. These values are maximums; for design and installation purposes these figures should be reduced by: 50% for 3/4" - 3-1/2"; 25% for 4" and larger to compensate for jobsite conditions.

** Deflection or angular movement given is the maximum value that a coupling allows. When using the given maximum angles for a curved layout, proper bracing should be used to counter pressure thrust that will occur when the system is pressurized. Flexible couplings can be used for angular movement and or thermal expansion, though please note individual coupling(s) cannot be used to their maximums for both types of movement within a system at the same time.

EXPANSION PIPE

Lever handles are factory assembled pretty tight for safety sake. The use of expansion pipes may be used to assist in closing and opening of the coupling.



EXPANSION PIPE SIZE	APPLICABLE COUPLING SIZES
1/2" x 6"	1-1/2" - 4"
3/4" x 8"	5" - 8"

(You can easily make your expansion pipe simply by cutting sch. 40 1/2" or 3/4" pipe to a proper length)

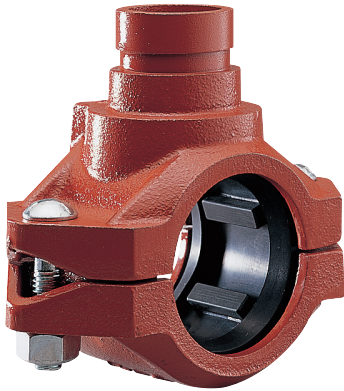

The Model C-7 Outlet Coupling combines the features of a coupling and a reducing outlet. The C-7 is a joining device with an integral reducing outlet, eliminating the need for a mechanical tee or a reducing tee and couplings. The C-7 is available with grooved, male threaded or female threaded outlets. The C-7 coupling is recommended for fire sprinkler services and other applications up to 500 psi (34.4 Bar) depending on the size and schedule of pipe being used. The C-7 can be used for dry pipe systems or vacuum services up to -10 inHg or 254 mmHg which may occur when the system is drained. All Model C-7 couplings are comprised of an upper and lower ductile iron housings segment, EPDM or Nitrile gaskets and plated track bolts and nuts. Housings are supplied with our standard orange paint or hot dipped zinc galvanized.

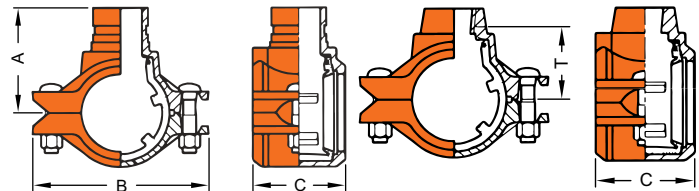
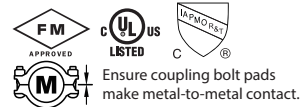

GROOVED OUTLET

THREADED OUTLET

DIMENSIONS

RUN PIPE	NOMINAL SIZE		MAX. WORKING PRESSURE (CWP)‡	AXIAL DISPLACEMENT	MAX. END LOAD (CWP)	DIMENSIONS				BOLT SIZE	WEIGHT
	OUTLET					T**	A	B	C		
	FPT	GR / MPT									
in	in	in	PSI	in	lb	in	in	in	in	in	lb
mm	mm	mm	Bar	mm	kN	mm	mm	mm	mm	mm	kg
1-1/2	1/2 3/4 1	---	500	0.81~0.88	1050	2.06 2.06 1.94	---	4.50	2.75	3/8 x 2-1/8	2.6 2.6 2.9
40	15 20 25	---	35	20~22	4.7	52 52 49	---	114.3	70.0	M10 x 55	1.2 1.2 1.3
2	1/2 3/4 1	---	500	0.81~0.88	2180	2.32 2.32 2.20	---	5.00	2.75	3/8 x 2-1/8	3.1 3.1 3.3
50	15 20 25	---	35	20~22	9.7	59 59 56	---	127.0	70.0	M10 X 55	1.4 1.4 1.5
2-1/2	1/2 3/4 1 1-1/4 ---	---	500	1.25~1.50	3200	2.20 2.56 2.44 2.36 ---	---	6.33	3.25	1/2 x 2-3/8	4.8 4.6 4.4 5.1 5.9
65	15 20 25 32 ---	---	35	32~38	14.2	56 65 62 60 ---	---	161.0	83.0	M12 X 60	2.2 2.1 2.0 2.3 2.4
3	3/4 1 1-1/4* 1-1/2	---	500	1.25~1.50	4750	2.83 2.75 2.75 2.75 ---	---	6.87	3.25	1/2 x 3	5.9 6.2 6.2 6.4
80	20 25 32 40	---	35	32~38	21.0	72 70 70 70 ---	---	175.0	83.0	M12 X 75	2.7 2.8 2.8 2.9
4	3/4 1 1-1/2 2	---	500	1.63~1.81	7840	3.70 3.58 3.31 3.50 ---	---	8.31	3.66	5/8 x 3-1/2	9.2 9.5 9.5 9.9
100	20 25 40 50	---	35	41~46	34.9	94 91 84 89 ---	---	211.0	93.0	M16 X 90	4.2 4.3 4.3 4.5
6	3/4 1 1-1/2 2 ---	---	400	1.63~1.81	14000	4.76 4.76 4.76 4.40 ---	---	10.86 3.70 10.86 3.70 11.04	3.70 3.70 13.6 14.3 18.7	5/8 x 3-1/2 5/8 x 3-1/2 5/8 x 3-1/2 3/4 x 4-3/4	13.2 13.2 13.6 14.3 18.7
150	20 25 40 50 ---	---	28	41~46	62.3	121 121 121 111 ---	---	276.0 276.0 276.0 276.0 280.5	94.0 94.0 94.0 94.0 104.0	M16 X 90 M16 X 90 M16 X 90 M16 X 90 M20 x 120	6.0 6.0 6.2 6.5 8.5

FPT: Female threaded outlet Gr: Grooved outlet MPT: Male threaded outlet.

** T: Center of run pipe to end of outlet pipe (dimensions approximate). Female threaded outlet only.

* Working pressure is based on roll grooved standard wall carbon steel pipe.

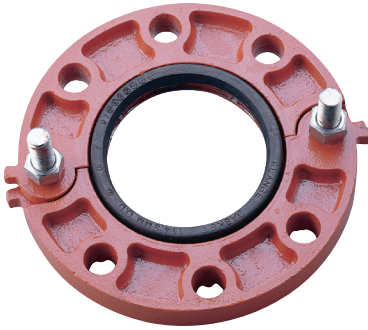

The Model 7041 Flange Adapter allows for a direct connection with ANSI class 125/150 flanges. The specially designed gasket enables the transition from a grooved system to a flanged system or component with this single flange adapter. The two-segment design provides an easy and fast installation. 2" through 12" flange adapters are supplied hinged as a single assembly, while 14" - 24" (Model 7041N) are supplied with two separate segments and a draw kit. All include an EPDM or Nitrile gasket and plated track bolts and nuts. Housing segments are supplied with our standard orange paint finish or hot dipped zinc galvanized.



Always fasten the bolts to the required torque.

Always use factory-supplied bolts and nuts to assemble flange segments. The use of other bolts may cause joint failure. If the factory supplied bolts cannot be used for the component that is being connected consult Shurjoint technical services for further guidance

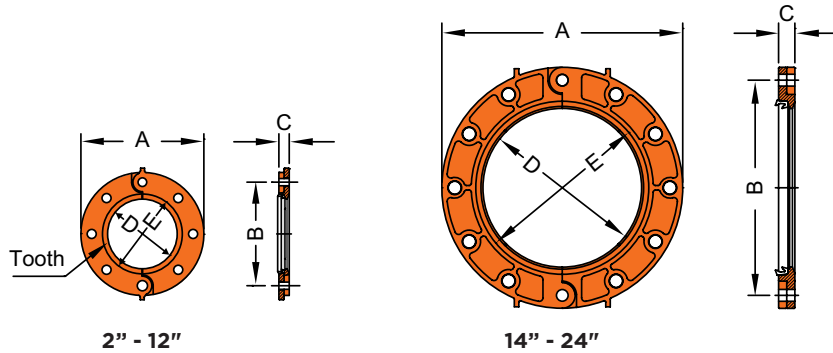

DIMENSIONS

NOMINAL SIZE	PIPE O.D.	MAX. WORKING PRESSURE (CWP)**	MAX. END LOAD (CWP)	DIMENSIONS					SEALING SURFACE		BOLT		WEIGHT
				A	B	C	D	E	NO.	SIZE			
in	in	PSI	lb	in	in	in	in	in		in	lb		
mm	mm	Bar	kN	mm	mm	mm	mm	mm			kg		
2	2.375	300	1330	6.00	4.75	0.75	2.38	3.07	4	5/8	4.0		
50	60.3	20	5.71	152	121	19	60	78			1.8		
2-1/2	2.875	300	1950	7.00	5.50	0.87	2.88	3.54	4	5/8	5.1		
65	73.0	20	8.37	178	140	22	73	90			2.3		
3	3.500	300	2880	7.52	6.00	0.94	3.50	4.17	4	5/8	6.2		
80	88.9	20	12.41	191	152	24	89	106			2.8		
4	4.500	300	4770	9.00	7.50	0.94	4.50	5.20	8	5/8	8.3		
100	114.3	20	20.51	229	191	24	114	132			3.8		
5	5.563	300	7290	10.00	8.50	1.00	5.56	6.26	8	3/4	10.3		
125	141.3	20	31.35	254	216	25	141	159			4.7		
6	6.625	300	10340	11.00	9.50	1.00	6.63	7.32	8	3/4	11.1		
150	168.3	20	44.47	279	241	25	168	186			5.0		
8	8.625	300	17520	13.50	11.75	1.14	8.63	9.29	8	3/4	17.2		
200	219.1	20	75.37	343	298	29	219	236			7.8		
10	10.750	300	27210	16.00	14.25	1.18	10.75	11.61	12	7/8	25.7		
250	273.0	20	117.01	406	362	30	273	295			11.7		
12	12.750	300	38280	19.02	17.00	1.25	12.75	13.62	12	7/8	37.6		
300	323.9	20	164.71	483	432	32	324	346			17.1		
14	14.000	300	46160	21.00	18.75	1.42	14.00	15.08	12	1	61.7		
350	355.6	20	198.5	533	476	36	356	383			28.0		
16	16.000	300	60290	23.50	21.25	1.42	16.00	16.97	16	1	77.1		
400	406.4	20	259.3	597	540	36	406	431			35.0		
18	18.000	300	76300	25.00	22.75	1.56	18.00	19.13	16	1-1/8	86.0		
450	457.2	20	328.2	635	578	40	457	486			39.0		
20	20.000	300	94200	27.50	25.00	1.73	20.00	21.14	20	1-1/8	109.1		
500	508.0	20	405.2	699	635	44	508	537			49.5		
24	24.000	300	135650	32.00	29.50	1.89	24.00	25.00	20	1-1/4	157.6		
600	609.6	20	583.4	813	749	48	610	635			71.5		

* Working Pressure is based on roll grooved standard wall carbon steel pipe.

Specified bolt torque is required. See page 70 in the Shurjoint Installation Instructions.



The Model #7041, #7043, #C341 & #A512 flange adapters require a hard flat surface for effective gasket sealing. A sandwich plate is required and should always be used when the mating surface is not adequate as seen with the serrated faces of some valves or the rubber-faced or rubber-lined flanges of a wafer valve.

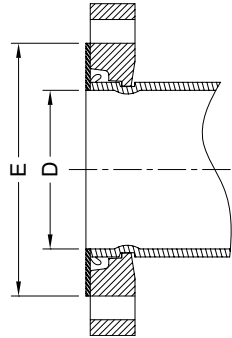

MATERIAL SPECIFICATIONS FITTING BODY:

- Carbon steel: electro-zinc plated
- Stainless steel: 316
- Stainless steel: 304

DIMENSIONS

NOMINAL SIZE	MODEL #49 FOR #7041 FLANGE ADAPTER		MODEL #A49 FOR #A512 FLANGE ADAPTER	
	E	D	E	D
in	in	in	in	in
mm	mm	mm	mm	mm
2	3.74	2.13	---	---
50	95	54	---	---
2-1/2	4.65	2.64	---	---
65	118	67	---	---
3	5.12	3.19	---	---
80	130	81	---	---
4	6.22	4.13	6.66	4.55
100	158	105	169	116
5	7.4	5	---	---
125	188	128	---	---
6	8.5	6.1	8.5	6.65
150	216	155	216	169
8	10.67	8.07	10.63	8.8
200	271	205	270	224
10	12.83	10.15	---	---
250	326	258	---	---
12	15	12	---	---
300	381	305	---	---
14	17.4	13.46	---	---
350	442	342	---	---
16	19.92	15.43	---	---
400	506	392	---	---
18	21.26	17.44	---	---
450	540	443	---	---
20	23.5	19.45	---	---
500	597	494	---	---
24	27.87	23.46	---	---
600	708	596	---	---



The Model 7043 flange adapter allows for a direct connection with ANSI Class 300 flanges. The specially designed gasket enables the transition from a grooved system to a flanged system or component with this single flange. 2" through 8" Model 7043 flange adapters are supplied hinged as a single assembly, while larger sizes are supplied with separate segments. The Model 7043 flange adapters are comprised of two identical ductile iron segments complete with an EPDM gasket and two pairs of bolts and nuts. The flange segments are painted black. The Model 7043 flange adapter has been designed with small projections on the outside face of the flange for mating with 1/16" (1.6 mm) raised face flanges. For mating with flat-face flanges these projections must be removed, this can be accomplished with a grinder or other tool.



Always fasten the bolts to the required torque.

Always use factory-supplied bolts and nuts to assemble flange segments. The use of other bolts may cause joint failure. If the factory supplied bolts cannot be used for the component that is being connected consult Shurjoint technical services for further guidance

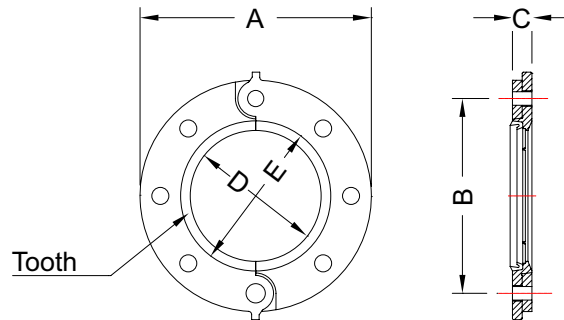

DIMENSIONS

NOMINAL SIZE	PIPE O.D.	MAX. WORKING PRESSURE (CWP)*	MAX. END LOAD (CWP)	DIMENSIONS			SEALING SURFACE		BOLT		WEIGHT
				A	B	C	D	E	NO.	SIZE	
in	in	PSI	lb	in	in	in	in	in		in	lb
mm	mm	Bar	kN	mm	mm	mm	mm	mm			kg
2	2.375	750	3320	6.50	5.00	0.94	2.38	3.07	8	5/8	5.3
50	60.3	52	14.84	165	127	24	60	78	8	3/4	2.4
2-1/2	2.875	750	4860	7.50	5.88	1.06	2.88	3.54	8	3/4	7.9
65	73.0	52	21.75	191	149	27	73	90	8	3/4	3.6
3	3.500	750	7210	8.25	6.63	1.19	3.50	4.17	8	3/4	10.0
80	88.9	52	32.26	210	168	30	89	106	8	3/4	4.6
4	4.500	750	11920	10.00	7.95	1.31	4.50	5.20	8	3/4	17.3
100	114.3	52	53.33	254	202	33	114	132	8	3/4	7.8
5	5.563	750	18220	11.00	9.25	1.44	5.56	5.55	8	3/4	21.3
125	141.3	52	81.50	279	235	37	141	141	8	3/4	9.7
6	6.625	750	25840	12.50	10.63	1.50	6.63	7.32	12	3/4	26.9
150	168.3	52	115.62	318	270	38	168	186	12	3/4	12.2
8	8.625	750	43790	15.00	13.00	1.61	8.63	9.29	12	7/8	36.2
200	219.1	52	195.96	381	330	41	219	236	12	7/8	16.4
10	10.750	750	68030	17.68	15.25	1.89	10.75	11.61	16	1	56.9
250	273.0	52	304.23	449	387	48	273	295	16	1	25.8
12	12.750	750	95700	20.50	17.75	1.93	12.75	13.62	16	1-1/8	77.7
300	323.9	52	428.25	521	451	49	324	346	16	1-1/8	35.2

*Working Pressure is based on roll grooved standard wall carbon steel pipe.

Specified bolt torque is required. See page 70 in the Shurjoint Installation Instructions.

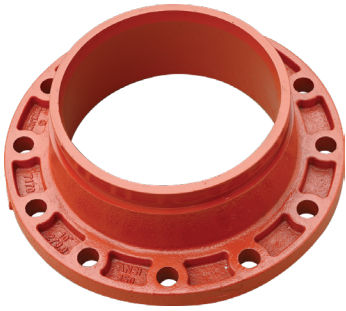

The Model 7170 Flange Adapter provides a rigid transition between ANSI class 125 / 150 flanged components and a grooved system.

Shurjoint standard fitting pressure ratings conform to the ratings of the connected grooved coupling used.

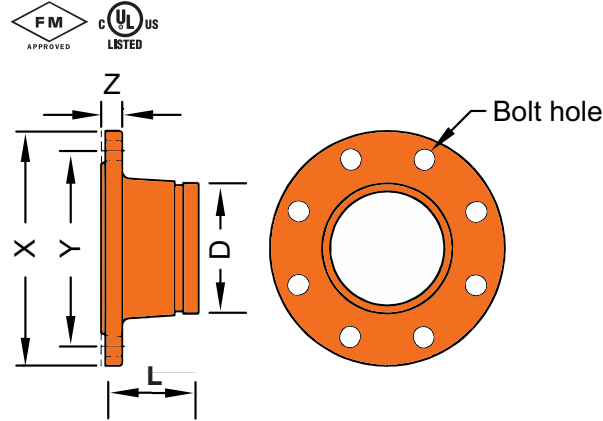

DIMENSIONS ANSI CLASS 125 / 150

NOMINAL SIZE	X	Y	Z	BOLT SIZE	BOLT HOLE		D	L	WEIGHT
					DIA.	NO.			
in	in	in	in	in	in		in	in	lb
mm	mm	mm	mm		mm		mm	mm	kg
10	15.98	14.25	1.18	7/8	1	12	10.75	7.99	48.4
250	406.0	362.0	30.0				273.0	203.0	22.0
12	19.00	17.00	1.25	7/8	1	12	12.75	7.99	61.6
300	483.0	432.0	32.0				323.9	203.0	28.0
14	21.00	18.75	1.38	1	1-1/8	12	14.00	5.00	108.9
350	533.0	476.3	35.0				355.6	127.0	49.5
16	23.50	21.25	1.46	1	1-1/8	16	16.00	5.00	110.0
400	597.0	539.7	37.0				406.4	127.0	50.0
18	25.00	22.75	1.57	1-1/8	1-1/4	16	18.00	5.50	137.5
450	635.0	577.8	40.0				457.2	140.0	62.5
20	27.50	25.00	1.69	1-1/8	1-1/4	20	20.00	5.71	158.4
500	699.0	635.0	43.0				508.0	145.0	72.0
24	32.00	29.50	1.89	1-1/4	1-3/8	20	24.00	6.00	218.9
600	813.6	749.3	48.0				609.6	152.0	99.5

DIMENSIONS ANSI CLASS 300 (FABRICATED)

NOMINAL SIZE	X	Y	Z	BOLT SIZE	BOLT HOLE		D	L	WEIGHT
					DIA.	NO.			
in	in	in	in	in	in		in	in	lb
mm	mm	mm	mm		mm		mm	mm	kg
2	6.5	5	0.875	5/8	3/4	8	2.375	4	8.58
50	165	127	22				60.3	101.6	3.9
2-1/2	7.5	5.875	1	3/4	7/8	8	2.875	4	10.12
65	191	149	25				73.0	101.6	4.6
3	8.25	6.625	1.125	3/4	7/8	8	3.500	4	10.34
80	210	168	29				88.9	101.6	4.7
4	10	7.875	1.25	3/4	7/8	8	4.500	6	16.94
100	254	200	32				114.3	152.4	7.7
6	12.5	10.625	1.438	3/4	7/8	12	6.625	6	28.6
150	318	270	37				168.3	152.4	13

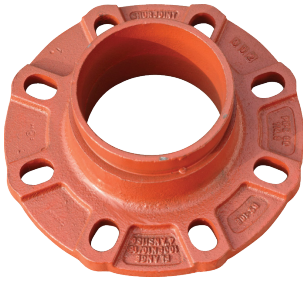

The Model 7180 Universal Flange Adapter provides all the benefits of our popular #7170 Flange Adapter with the added benefit of mating to a range of flange types including ANSI 125/150, PN10, PN16, JIS 10K and BS- 10E.

Raised face flange #7180F available upon request.

Shurjoint Model 7180 pressure ratings conform to the working pressure of the coupling used to join the system.

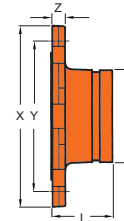
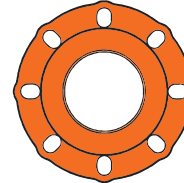

DIMENSIONS

NOMINAL SIZE	PIPE O.D.	L	X	Y: FLANGE DRILLING				Z	BOLT SIZE		WEIGHT
				ANSI	PN	JIS	BS		DIA	NO.	
				125 / 150	10 / 16	10K	10E				
in	in	in	in	in	in	in	in	in		lb	
mm	mm	mm	mm	mm	mm	mm	mm	mm		kg	
2	2.375	2.50	6.50	4.75	4.92	4.72	4.49	0.63	5/8	4	5.10
50	60.3	64	165	121	125	120	114	16	M16	4	2.30
2-1/2	2.875	2.99	7.28	5.50	5.70	5.50	5.00	0.63	5/8	4	6.53
65	73.0	76	185	140	145	140	127	16	M16	4	2.96
3	3.500	2.95	7.87	6.00	6.30	5.90	5.75	0.63	5/8	4 / 8	7.47
80	88.9	75	200	152	160	150	146	16	M16	4 / 8	3.39
4	4.500	2.95	8.86	7.50	7.09	6.89	7.00	0.63	5/8	8	8.49
100	114.3	75	225	191	180	175	178	16	M16	8	3.85
5	5.563	2.95	10.00	8.50	8.27	8.27	---	0.87	5/8 / 3/4	8	14.33
125	141.3	75	254	216	210	210	---	22	M16 / M20	8	6.50
6	6.625	2.95	10.71	9.50	9.45	9.45	---	0.63	3/4	8	12.58
150	168.3	75	272	241	240	240	---	16	M20	8	5.72
8	8.625	4.00	13.50	11.75	11.61	11.42	11.50	0.87	3/4	8 / 12	30.09
200	219.1	102	343	298	295	290	292	22	M20	8 / 12	13.65

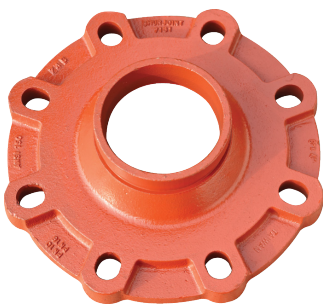

7181 UNIVERSAL REDUCING FLANGE ADAPTER

The Model 7181 Universal Reducing Flange Adapter provides a rigid transition between a flanged piping system and a one or two-size reduced grooved system without the need of a concentric reducer. The flange drilling is compatible to ANSI 125/150, PN10/16, BS-10E and JIS 10K.

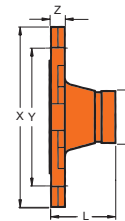
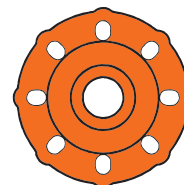

DIMENSIONS

NOMINAL SIZE	PIPE O.D.	L	X	Z	Y: FLANGE DRILLING			D	BOLT		WEIGHT
					ANSI 125 / 150	PN 10 / 16	JIS 10K		DIA.	NO.	
in	in	in	in	in	in	in	in	in		lb	
mm	mm	mm	mm	mm	mm	mm	mm	mm		kg	
3 x 2	3.500 x 2.375	2.95	8.19	0.63	8.00	6.30	5.90	2.000	5/8	8	5.95
80 x 50	88.9 x 60.3	75.0	208.0	16.0	152	160	150	60.3	M16		2.70
4 x 2-1/2	4.500 x 2.875	3.00	8.88	0.63	7.52	7.09	6.89	2.875	5/8	8	8.80
100 x 65	114.3 x 73.0	76.0	225.5	16.0	191	180	175	73.0	M16		4.00
4 x 3	4.500 x 3.500	2.95	8.88	0.63	7.50	7.09	6.89	3.000	5/8	8	7.61
100 x 80	114.3 x 88.9	75.0	225.5	16.0	191	180	175	88.9	M16		3.45
6 x 4	6.625 x 4.500	2.95	11.46	0.95	9.50	9.45	9.45	4.000	3/4	8	15.61
150 x 100	168.3 x 114.3	75.0	291.0	24.0	241	240	240	114.3	M20		7.08

7721 MECHANICAL TEE FEMALE THREADED OUTLET



The Model 7721 Mechanical Tee when mounted on hole cut pipe provides a fast and easy mid-pipe threaded branch outlet. By utilizing the Model 7721 you eliminate the need for welding or the use of multiple fittings. The Mechanical Tee is comprised of upper and lower ductile iron housing segments, a grade "E" EPDM or "T" Nitrile rubber molded gasket and plated track bolts and nuts. Mechanical tees are supplied with our standard orange paint or hot dipped zinc galvanized.

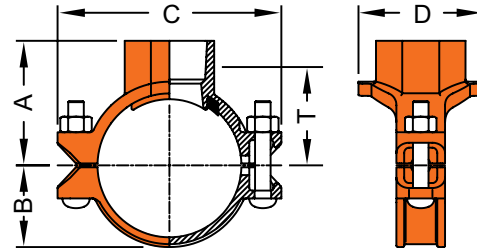
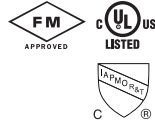

DIMENSIONS

NOMINAL SIZE RUN X BRANCH	MAX. WORKING PRESSURE (CWP)*	DIMENSIONS					BOLT SIZE	WEIGHT
		T±	A	B	C	D		
in	PSI	in	in	in	in	in	in	lb
mm	Bar	mm	mm	mm	mm	mm	mm	kg
2 x 1/2	300	1.97	2.50	1.57	5.04	2.87	3/8 x 2-1/8	2.4
50 x 15	20	50	64	40	128	73	M10 x 55	1.1
2 x 3/4	300	1.97	2.50	1.57	5.04	2.87	3/8 x 2-1/8	2.4
50 x 20	20	50	64	40	128	73	M10 x 55	1.1
2 x 1	300	2.00	2.68	1.57	5.04	2.87	3/8 x 2-1/8	2.6
50 x 25	20	51	68	40	128	73	M10 x 55	1.2
2 x 1-1/4	300	2.08	2.80	1.57	5.04	3.22	3/8 x 2-1/8	2.9
50 x 32	20	53	71	40	128	82	M10 x 55	1.3
2 x 1-1/2	300	2.08	2.80	1.57	5.04	3.22	3/8 x 2-1/8	2.9
50 x 40	20	53	71	40	128	82	M10 x 55	1.3
2-1/2 x 1/2	300	2.25	2.80	1.89	5.75	2.87	1/2 x 3	3.1
65 x 15	20	57	71	48	146	73	M12 x 75	1.4
2-1/2 x 3/4	300	2.32	2.88	1.89	5.75	2.87	1/2 x 3	3.1
65 x 20	20	59	73	48	146	73	M12 x 75	1.4
2-1/2 x 1	300	2.28	2.95	1.89	5.75	2.87	1/2 x 3	3.3
65 x 25	20	58	75	48	146	73	M12 x 75	1.5
2-1/2 x 1-1/4	300	2.40	3.11	1.89	5.75	3.22	1/2 x 3	3.5
65 x 32	20	61	79	48	146	82	M12 x 75	1.6
2-1/2 x 1-1/2	300	2.40	3.11	1.89	5.75	3.22	1/2 x 3	3.5
65 x 40	20	61	79	48	146	82	M12 x 75	1.6
3 x 1/2	300	2.47	3.19	2.20	6.39	2.63	1/2 x 3	3.5
80 x 15	20	63	81	56	160	67	M12 x 75	1.6
3 x 3/4	300	2.44	3.19	2.20	6.39	2.63	1/2 x 3	3.5
80 x 20	20	62	81	56	160	67	M12 x 75	1.6
3 x 1	300	2.50	3.19	2.20	6.39	2.63	1/2 x 3	3.7
80 x 25	20	64	81	56	160	67	M12 x 75	1.7
3 x 1-1/4	300	2.80	3.50	2.20	6.39	3.46	1/2 x 3	4.2
80 x 32	20	71	89	56	160	88	M12 x 75	1.9
3 x 1-1/2	300	2.80	3.50	2.20	6.39	3.46	1/2 x 3	4.4
80 x 40	20	71	89	56	160	88	M12 x 75	2.0
3 x 2	300	2.83	3.58	2.20	6.39	3.98	1/2 x 3	5.1
80 x 50	20	72	91	56	160	101	M12 x 75	2.3
4 x 1/2	300	3.00	3.70	2.83	7.48	2.63	1/2 x 3	4.2
100 x 15	20	76	94	72	190	67	M12 x 75	1.9
4 x 3/4	300	2.95	3.70	2.83	7.48	2.63	1/2 x 3	4.2
100 x 20	20	75	94	72	190	67	M12 x 75	1.9
4 x 1	300	3.03	3.70	2.83	7.48	2.63	1/2 x 3	4.4
100 x 25	20	77	94	72	190	67	M12 x 75	2.0
4 x 1-1/4	300	3.19	3.89	2.83	7.48	3.35	1/2 x 3	4.8
100 x 32	20	81	99	72	190	85	M12 x 75	2.2
4 x 1-1/2	300	3.19	3.89	2.83	7.48	3.35	1/2 x 3	5.1
100 x 40	20	81	99	72	190	85	M12 x 75	2.3
4 x 2	300	3.38	4.13	2.83	7.48	3.98	1/2 x 3	5.9
100 x 50	20	86	105	72	190	101	M12 x 75	2.7
4 x 2-1/2	300	3.23	4.37	2.83	7.48	4.40	1/2 x 3	7.3
100 x 65	20	82	111	72	190	112	M12 x 75	3.3

Continued on next page.

7721 MECHANICAL TEE FEMALE THREADED OUTLET

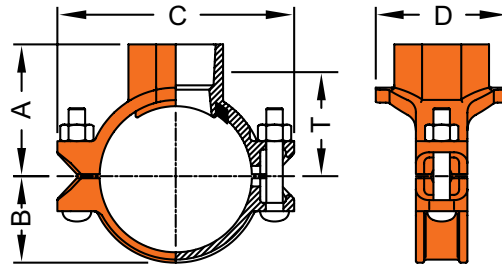

Continued from previous page.

NOMINAL SIZE RUN X BRANCH	MAX. WORKING PRESSURE (CWP)*	DIMENSIONS					BOLT SIZE	WEIGHT
		T‡	A	B	C	D		
in	PSI	in	in	in	in	in	in	lb
mm	Bar	mm	mm	mm	mm	mm	mm	kg
4 x 3	300	3.23	4.40	2.83	7.48	5.35	5/8 x 3-1/2	12.3
100 x 80	20	82	112	72	190	136	M16 x 90	5.6
5 x 2	300	4.13	4.88	3.39	9.29	4.00	5/8 x 3-1/2	9.2
125 x 50	20	105	124	86	236	102	M16 x 90	4.2
5 x 2-1/2	300	3.89	5.00	3.39	9.29	4.65	5/8 x 3-1/2	9.9
125 x 65	20	99	127	86	236	118	M16 x 90	4.5
6 x 1/2	300	4.48	5.03	3.86	10.07	3.50	5/8 x 55/16	9.7
150 x 15	20	114	128	98	256	89	M16 x 135	4.4
6 x 1	300	4.33	5.00	3.86	10.07	3.50	5/8 x 55/16	9.7
150 x 25	20	110	127	98	256	89	M16 x 135	4.4
6 x 1-1/4	300	4.29	5.00	3.86	10.07	3.66	5/8 x 55/16	9.7
150 x 32	20	109	127	98	256	93	M16 x 135	4.4
6 x 1-1/2	300	4.29	5.00	3.86	10.07	3.66	5/8 x 55/16	9.7
150 x 40	20	109	127	98	256	93	M16 x 135	4.4
6 x 2	300	4.45	5.29	3.86	10.07	3.98	5/8 x 55/16	10.6
150 x 50	20	113	132	98	256	101	M16 x 135	4.8
6 x 2-1/2	300	4.37	5.50	3.86	10.07	4.65	5/8 x 55/16	11.9
150 x 65	20	111	140	98	256	118	M16 x 135	5.4
6 x 3	300	4.33	5.50	3.86	10.07	5.39	5/8 x 55/16	13.2
150 x 80	20	110	140	98	256	137	M16 x 135	6.0
6 x 4	300	4.21	5.50	3.86	10.07	6.46	5/8 x 55/16	14.5
150 x 100	20	107	140	98	256	164	M16 x 135	6.6
8 x 1/2	300	5.31	5.82	4.72	12.87	4.40	3/4 x 4-3/4	12.5
200 x 15	20	135	148	120	327	112	M20 x 120	5.7
8 x 1	300	5.31	5.98	4.72	12.87	4.40	3/4 x 4-3/4	12.5
200 x 25	20	135	152	120	327	112	M20 x 120	5.7
8 x 1-1/4	300	5.31	5.98	4.72	12.87	3.98	3/4 x 4-3/4	12.5
200 x 32	20	135	152	120	327	101	M20 x 120	5.7
8 x 1-1/2	300	5.31	5.98	4.72	12.87	3.98	3/4 x 4-3/4	12.5
200 x 40	20	135	152	120	327	101	M20 x 120	5.7
8 x 2	300	5.31	6.54	4.72	12.87	3.98	3/4 x 4-3/4	13.6
200 x 50	20	135	166	120	327	101	M20 x 120	6.2
8 x 2-1/2	300	5.39	6.54	4.72	12.87	4.09	3/4 x 4-3/4	13.9
200 x 65	20	137	166	120	327	104	M20 x 120	6.3
8 x 3	300	5.35	6.54	4.72	12.87	5.04	3/4 x 4-3/4	15.6
200 x 80	20	136	166	120	327	128	M20 x 120	7.1
8 x 4	300	5.24	6.54	4.72	12.87	6.46	3/4 x 4-3/4	17.6
200 x 100	20	133	166	120	327	164	M20 x 120	8.0

‡ T: Take-Out (Center of run to end of pipe to be engaged.)

*Working pressure is based on standard wall carbon steel pipe.

7722 MECHANICAL TEE GROOVED-END OUTLET

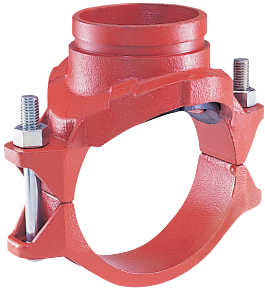

The Model 7722 Mechanical Tee when mounted on the hole cut pipe provides a fast and easy mid-pipe grooved end branch outlet. By utilizing the Model 7722 you eliminate the need for welding or the use of multiple fittings. The mechanical Tee is comprised of upper and lower ductile iron housing segments, a grade "E" EPDM or "T" Nitrile rubber molded gasket and plated track bolts and nuts. Mechanical tees are supplied with our standard orange paint or hot dipped zinc galvanized.

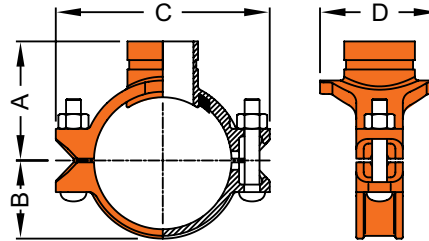

DIMENSIONS

NOMINAL SIZE RUN X BRANCH	MAX. WORKING PRESSURE (CWP)*	DIMENSIONS					BOLT SIZE	WEIGHT
		T#	A	B	C	D		
in mm	PSI Bar	in mm	in mm	in mm	in mm	in mm	in mm	lb kg
2 x 1*	2.375 x 1.315	1.50	2.68	1.57	5.04	2.87	3/8 x 2-1/8	2.2
50 x 25	60.3 x 33.4	38	68	40	128	73	M10 x 55	1.0
2 x 1-1/4	2.375 x 1.660	1.75	2.80	1.57	5.04	3.22	3/8 x 2-1/8	2.2
50 x 32	60.3 x 42.2	45	71	40	128	82	M10 x 55	1.0
2 x 1-1/2	2.375 x 1.900	1.75	2.80	1.57	5.04	3.22	3/8 x 2-1/8	2.6
50 x 40	60.3 x 48.3	45	71	40	128	82	M10 x 55	1.2
2-1/2 x 1*	2.875/3.000 x 1.315	1.50	2.95	1.89	5.75	2.87	1/2 x 3	4.0
65 x 25	73.0/76.1 x 33.4	38	75	48	146	73	M12 x 75	1.8
2-1/2 x 1-1/4	2.875/3.000 x 1.660	2.00	3.11	1.89	5.75	3.22	1/2 x 3	3.7
65 x 32	73.0/76.1 x 42.2	51	79	48	146	82	M12 x 75	1.7
2-1/2 x 1-1/2	2.875/3.000 x 1.900	2.00	3.11	1.89	5.75	3.22	1/2 x 3	4.2
65 x 40	73.0/76.1 x 48.3	51	79	48	146	82	M12 x 75	1.9
3 x 1	3.500 x 1.315	1.50	3.30	2.20	6.30	2.91	1/2 x 3	3.7
80 x 25	88.9 x 33.4	38	84	56	160	74	M12 x 75	1.7
3 x 1-1/4	3.500 x 1.660	2.00	3.50	2.20	6.30	3.46	1/2 x 3	4.0
80 x 32	88.9 x 42.2	51	89	56	160	88	M12 x 75	1.8
3 x 1-1/2	3.500 x 1.900	2.00	3.50	2.20	6.30	3.46	1/2 x 3	4.2
80 x 40	88.9 x 48.3	51	89	56	160	88	M12 x 75	1.9
3 x 2	3.500 x 2.375	2.50	3.58	2.20	6.30	3.98	1/2 x 3	4.8
80 x 50	88.9 x 60.3	64	91	56	160	101	M12 x 75	2.2
4 x 1	4.500 x 1.315	1.50	3.89	2.83	7.48	2.63	1/2 x 3	4.4
100 x 25	114.3 x 33.4	38	94	72	190	67	M12 x 75	2.0
4 x 1-1/4	4.500 x 1.660	2.00	3.89	2.83	7.48	3.35	1/2 x 3	4.6
100 x 32	114.3 x 42.2	51	99	72	190	85	M12 x 75	2.1
4 x 1-1/2	4.500 x 1.900	2.00	3.89	2.83	7.48	3.35	1/2 x 3	4.8
100 x 40	114.3 x 48.3	51	99	72	190	85	M12 x 75	2.2
4 x 2	4.500 x 2.375	2.50	4.13	2.83	7.48	3.98	1/2 x 3	5.9
100 x 50	114.3 x 60.3	64	105	72	190	101	M12 x 75	2.7
4 x 2-1/2	4.500 x 2.875	2.75	4.37	2.83	7.48	4.40	1/2 x 3	6.6
100 x 65	114.3 x 73.0	70	111	72	190	112	M12 x 75	3.0
4 x 2-1/2	4.500 x 3.000	2.75	4.37	2.83	7.48	4.40	1/2 x 3	6.6
100 x 65	114.3 x 76.1	70	111	72	190	112	M12 x 75	3.0
4 x 3	4.500 x 3.500	3.50	4.40	2.83	7.48	5.35	5/8 x 3-1/2	11.4
100 x 80	114.3 x 88.9	89	112	72	190	136	M16 x 90	5.2
5 x 2	5.500/5.563 x 2.375	2.50	4.88	3.39	9.29	4.00	5/8 x 3-1/2	9.2
125 x 50	139.7/141.3 x 60.3	64	124	86	236	102	M16 x 90	4.2
5 x 2-1/2	5.563 x 2.875	2.75	5.00	3.39	9.29	4.65	5/8 x 3-1/2	9.5
125 x 65	141.3 x 73.0	70	127	86	236	118	M16 x 90	4.2
5 x 2-1/2	5.500 x 3.000	2.75	5.00	3.39	9.29	4.65	5/8 x 3-1/2	9.5
125 x 65	139.7 x 76.1	70	127	86	236	118	M16 x 90	4.3
6 x 1-1/4	6.500/6.625 x 1.660	2.00	5.00	3.86	10.08	3.66	5/8 x 55/16	9.2
150 x 32	165.1/168.3 x 42.2	51	127	98	256	93	M16 x 135	4.2
6 x 1-1/2	6.500/6.625 x 1.900	2.00	5.00	3.86	10.08	3.66	5/8 x 55/16	9.5
150 x 40	165.1/168.3 x 48.3	51	127	98	256	93	M16 x 135	4.3
6 x 2	6.500/6.625 x 2.375	2.50	5.20	3.86	10.08	3.98	5/8 x 55/16	10.6
150 x 50	165.1/168.3 x 60.3	64	132	98	256	101	M16 x 135	4.8
6 x 2-1/2	6.625 x 2.875	2.75	5.50	3.86	10.08	4.65	5/8 x 55/16	12.1
150 x 65	168.3 x 73.0	70	140	98	256	118	M16 x 135	5.5
6 x 2-1/2	6.500 x 3.000	2.75	5.50	3.86	10.08	4.65	5/8 x 55/16	12.1
150 x 65	165.1 x 76.1	70	140	98	256	118	M16 x 135	5.5
6 x 3	6.500/6.625 x 3.500	3.50	5.50	3.86	10.08	5.39	5/8 x 55/16	12.3
150 x 80	165.1/168.3 x 88.9	89	140	98	256	137	M16 x 135	5.6

Continued on next page.

7722 MECHANICAL TEE GROOVED-END OUTLET

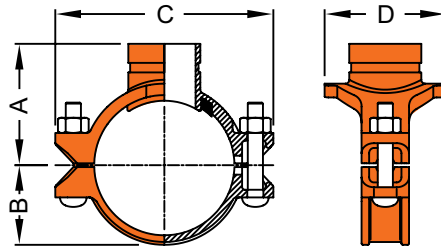
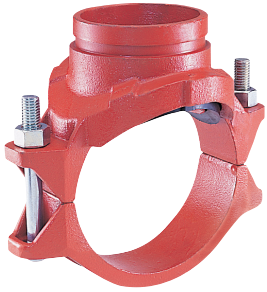

Continued from previous page.

NOMINAL SIZE RUN X BRANCH	MAX. WORKING PRESSURE (CWP)*	DIMENSIONS					BOLT SIZE	WEIGHT
		T‡	A	B	C	D		
in	PSI	in	in	in	in	in	in	lb
mm	Bar	mm	mm	mm	mm	mm	mm	kg
6 x 4	6.500/6.625 x 4.500	4.50	5.50	3.86	10.08	6.46	5/8 x 55/16	15.4
150 x 100	165.1/168.3 x 114.3	114	140	98	256	164	M16 x 135	7.0
8 x 2	8.625 x 2.375	2.75	6.54	4.72	12.87	3.89	3/4 x 4-3/4	12.8
200 x 50	219.1 x 60.3	70	166	120	327	104	M20 x 120	5.8
8 x 2-1/2	8.625 x 2.875	2.75	6.54	4.72	12.87	4.09	3/4 x 4-3/4	13.2
200 x 65	219.1 x 73.0	70	166	120	327	104	M20 x 120	6.0
8 x 2-1/2	8.625 x 3.000	2.75	6.54	4.72	12.87	4.09	3/4 x 4-3/4	13.2
200 x 65	219.1 x 76.1	70	166	120	327	104	M20 x 120	6.0
8 x 3	8.625 x 3.500	3.50	6.54	4.72	12.87	5.04	3/4 x 4-3/4	15.8
200 x 80	219.1 x 88.9	89	166	120	327	128	M20 x 120	7.2
8 x 4	8.625 x 4.500	4.50	6.54	4.72	12.87	6.46	3/4 x 4-3/4	16.5
200 x 100	219.1 x 114.3	114	166	120	327	164	M20 x 120	7.5
8 x 4	8.625 x 4.500	4.50	6.54	4.72	12.87	6.46	3/4 x 4-3/4	16.5
200 x 100	219.1 x 114.3	114	166	120	327	164	M20 x 120	7.5

‡ T: Take-Out (Center of run to end of pipe to be engaged.)

[] Important: Make special note of the hole saw size and maximum diameter allowed on these sizes, deviation could lead to joint failure.

*Working pressure is based on standard wall carbon steel pipe.

The following tables show maximum working pressures (CWP) of Shurjoint ductile iron couplings and flange adapters used on both carbon steel and stainless steel pipes. Shurjoint ductile iron couplings can be used in conjunction with stainless steel pipe in non-corrosive environment as the flow media does not come in direct contact with the coupling housings but rather only the gasket.

MODEL M07 ON CARBON STEEL PIPE

NOMINAL SIZE	CUT-GROOVED		ROLL-GROOVED	
	XS	STD	STD	SCH. 10
in	psi	psi	psi	psi
mm	Bar	Bar	Bar	Bar
2	750	750	750	750
50	52	52	52	52
2-1/2	750	750	750	600
65	52	52	52	42
3	750	750	750	600
80	52	52	52	42
4	750	750	750	600
100	52	52	52	42
5	750	750	750	500
125	52	52	52	35
6	700	700	700	500
150	48	48	48	35
8	600	600	600	300
200	42	42	42	20

MODEL M07 ON STAINLESS STEEL PIPE

NOMINAL SIZE	CUT-GROOVED		ROLL-GROOVED	
	XS	STD	STD	SCH. 10
in	psi	psi	psi	psi
mm	Bar	Bar	Bar	Bar
2	600	600	600	300
50	42	42	42	21
2-1/2	600	600	600	300
65	42	42	42	21
3	600	600	600	300
80	42	42	42	21
4	600	600	600	300
100	42	42	42	21
5	600	600	600	300
125	42	42	42	20
6	600	600	600	300
150	42	42	42	21
8	400	400	400	150
200	28	28	28	10

MODEL Z07 ON CARBON STEEL PIPE

NOM. SIZE	CUT-GROOVED		ROLL-GROOVED		
	XS	STD	STD	SCH. 10	SCH. 5
in	psi	psi	psi	psi	psi
mm	Bar	Bar	Bar	Bar	Bar
1-1/4	750	750	750	750	400
32	52	52	52	52	28
1-1/2	750	750	750	750	400
40	52	52	52	52	28
2	750	750	750	700	400
50	52	52	52	48	28
2½	750	750	750	700	400
65	52	52	52	48	28
3	750	750	750	600	400
80	52	52	52	42	28
4	750	750	750	600	400
100	52	52	52	42	28
5	750	750	750	500	350
125	52	52	52	35	24
6	700	700	700	400	300
150	48	48	48	28	20
8	600	600	600	350	250
200	42	42	42	24	17
10	500	500	500	300	200
250	35	35	35	20	14
12	400	400	400	250	150
300	28	28	28	17	10

MODEL Z07 ON STAINLESS STEEL PIPE

NOM. SIZE	CUT-GROOVED		ROLL-GROOVED		
	SCH. 80S	SCH. 40S	SCH. 40S	SCH. 10S	SCH. 5S
in	psi	psi	psi	psi	psi
mm	Bar	Bar	Bar	Bar	Bar
1-1/4	750	750	750	750	300
32	52	52	52	52	20
1-1/2	750	750	750	750	300
40	52	52	52	52	20
2	750	750	750	700	300
50	52	52	52	48	20
2½	750	750	750	700	300
65	52	52	52	48	20
3	750	750	750	500	300
80	52	52	52	34	20
4	750	750	750	500	250
100	52	52	52	34	17
5	750	650	650	500	NR
125	52	45	45	34	NR
6	700	600	600	300	NR
150	48	41	41	21	NR
8	600	450	450	300	NR
200	42	31	31	21	NR
10	500	450	450	150	NR
250	35	31	31	10	NR
12	400	400	400	100	NR
300	28	28	28	7	NR

MODEL Z07N ON CARBON STEEL PIPE

NOM. SIZE	CUT-GROOVED		ROLL-GROOVED	
	XS (0.500")	STD (0.375")	STD (0.375")	LW (0.312")
in	psi	psi	psi	psi
mm	Bar	Bar	Bar	Bar
14	250	250	250	250
350	17	17	17	17
16	250	250	250	250
400	17	17	17	17
18	250	250	250	250
450	17	17	17	17
20	250	250	250	250
500	17	17	17	17
24	250	250	250	250
600	17	17	17	17

MODEL Z05 ON CARBON STEEL PIPE

NOM. SIZE	CUT-GROOVED		ROLL-GROOVED	
	XS	STD	STD	SCH. 10
in	psi	psi	psi	psi
mm	Bar	Bar	Bar	Bar
1-1/4	600	500	500	400
32	42	35	35	28
1-1/2	600	500	500	400
40	42	35	35	28
2	600	500	500	400
50	42	35	35	28
2-1/2	600	500	500	400
65	42	35	35	28
3	600	500	500	400
80	42	35	35	28
4	600	500	500	400
100	42	35	35	28
5	450	350	350	300
125	31	24	24	20
6	450	350	350	300
150	31	24	24	20
8	450	430	350	300
200	31	24	24	20

MODEL Z05 ON STAINLESS STEEL PIPE

NOM. SIZE	CUT-GROOVED		ROLL-GROOVED		
	SCH. 80S	SCH. 40S	SCH. 40S	SCH. 10S	SCH. 5S
in	psi	psi	psi	psi	psi
mm	Bar	Bar	Bar	Bar	Bar
1-1/4	600	450	450	300	250
32	42	31	31	20	17
1-1/2	600	450	450	300	250
40	42	31	31	20	17
2	600	450	450	300	250
50	42	31	31	20	17
2-1/2	600	450	450	300	250
65	42	31	31	20	17
3	600	450	450	300	250
80	42	31	31	20	17
4	600	450	450	300	200
100	42	31	31	20	14
5	450	300	300	200	NR
125	31	20	20	14	
6	450	300	300	125	NR
150	31	20	20	9	
8	450	300	300	100	NR
200	31	20	20	7	

MODEL 7707 ON CARBON STEEL PIPE

NOM. SIZE	CUT-GROOVED		ROLL-GROOVED		
	XS	STD	STD	SCH. 10	SCH. 5
in	psi	psi	psi	psi	psi
mm	Bar	Bar	Bar	Bar	Bar
3/4	1000	1000	1000*	750*	325
20	69	69	69* / 52	52* / 42	22
1	1000	1000	1000* / 750	750* / 600	325
25	69	69	69* / 52	52* / 42	22
1-1/4	1000	1000	1000* / 750	750* / 600	325
32	69	69	69* / 52	52* / 42	22
1-1/2	1000	1000	1000* / 750	750* / 600	325
40	69	69	69* / 52	52* / 42	22
2	1000	1000	1000* / 750	750* / 600	325
50	69	69	69* / 52	52* / 42	22
2-1/2	1000	1000	1000* / 750	600	325
65	69	69	69* / 52	42	22
3	1000	1000	1000* / 750	600	325
80	69	69	69* / 52	42	22
4	1000	1000	1000* / 750	600	250
100	69	69	69* / 52	42	17
5	1000	1000	1000* / 750	500	NR
125	69	69	69* / 52	35	NR
6	1000	1000	1000* / 700	450	NR
150	69	69	69* / 48	31	NR
8	800	800	800* / 600	350	NR
200	55	55	55* / 42	24	NR
10	800	800	800* / 500	300	NR
250	55	55	55* / 38	20	NR
12	800	800	800* / 500	300	NR
300	55	55	55* / 35	20	NR

MODEL 7707 ON STAINLESS STEEL PIPE

NOM. SIZE	CUT-GROOVED		ROLL-GROOVED		
	SCH. 80S	SCH. 40S	SCH. 40S	SCH. 10S	SCH. 5S
in	psi	psi	psi	psi	psi
mm	Bar	Bar	Bar	Bar	Bar
3/4	750	750	750	500	325
20	52	52	52	34	22
1	750	750	750	500	325
25	52	52	52	34	22
1-1/4	750	750	750	500	325
32	52	52	52	34	22
1-1/2	750	750	750	500	325
40	52	52	52	34	22
2	750	750	750	500	325
50	52	52	52	34	22
2-1/2	750	750	750	500	325
65	52	52	52	34	22
3	750	750	750	500	325
80	52	52	52	34	22
4	750	750	750	500	250
100	52	52	52	34	17
5	750	650	650	500	NR
125	52	45	45	34	NR
6	750	500	500	300	NR
150	52	34	34	21	NR
8	600	450	450	150	NR
200	42	31	31	10	NR
10	600	400	400	125	NR
250	42	28	28	9	NR
12	600	400	400	125	NR
300	42	28	28	9	NR

MODEL 7707N ON CARBON STEEL PIPE

NOM. SIZE	CUT-GROOVED	ROLL-GROOVED	
	XS (0.500")	STD (0.375")	LW (0.312")
in	psi	psi	psi
mm	Bar	Bar	Bar
14	300	300	250
350	20	20	17
16	300	300	250
400	20	20	17
18	300	300	250
450	20	20	17
20	300	300	250
500	20	20	17
22	300	300	250
550	20	20	17
24	300	300	250
600	20	20	17
26	300	300	250
650	20	20	17

MODEL 7707L ON CARBON STEEL PIPE

NOM. SIZE	CUT-GROOVED	ROLL-GROOVED	
	XS (0.500")	STD (0.375")	LW (0.312")
in	psi	psi	psi
mm	Bar	Bar	Bar
28	250	175	125
700	17	12	9
30	250	175	125
750	17	12	9
32	250	175	125
800	17	12	9
34	250	175	125
850	17	12	9
36	250	175	125
900	17	12	9
40	250	175	125
1000	17	12	9
42	250	175	NR
1050	17	12	NR

MODEL 7705 ON CARBON STEEL PIPE

NOM. SIZE	CUT-GROOVED		ROLL-GROOVED		
	XS	STD	STD	SCH. 10	SCH. 5
in	psi	psi	psi	psi	psi
mm	Bar	Bar	Bar	Bar	Bar
1	600	750	750	500	250
25	42	52	52	35	17
1-1/4	600	750	750	500	250
32	42	52	52	35	17
1-1/2	600	650	650	500	250
40	42	45	45	35	17
2	600	500	500	500	250
50	42	35	35	35	17
2-1/2	600	500	500	500	250
65	42	35	35	35	17
3	600	500	500	400	250
80	42	35	35	28	17
4	600	500	500	400	200
100	42	35	35	28	14
5	450	450	450	350	NR
125	31	31	31	24	NR
6	450	450	450	350	NR
150	31	31	31	24	NR
8	450	300	300	250	NR
200	31	20	20	17	NR
10	350	300	300	200	NR
250	24	20	20	14	NR
12	350	300	300	200	NR
300	24	20	20	14	NR

MODEL 7705 ON STAINLESS STEEL PIPE

NOM. SIZE	CUT-GROOVED		ROLL-GROOVED		
	SCH. 80S	SCH. 40S	SCH. 40S	SCH. 10S	SCH. 5S
in	psi	psi	psi	psi	psi
mm	Bar	Bar	Bar	Bar	Bar
1	750	750	750	500	250
25	52	52	52	35	17
1-1/4	750	750	750	500	250
32	52	52	52	35	17
1-1/2	650	650	650	500	250
40	45	45	45	35	17
2	500	500	500	500	250
50	34	34	34	35	17
2-1/2	500	500	500	500	250
65	34	34	34	35	17
3	500	500	500	400	250
80	34	34	34	28	17
4	500	500	500	400	200
100	34	34	34	28	14
5	450	450	450	350	NR
125	31	31	31	24	NR
6	300	300	300	125	NR
150	21	21	21	9	NR
8	300	300	300	100	NR
200	21	21	21	7	NR
10	200	200	200	75	NR
250	14	14	14	5	NR
12	200	200	200	50	NR
300	14	14	14	3	NR

MODEL 7706 ON CARBON STEEL PIPE

NOM. SIZE	CUT-GROOVED		ROLL-GROOVED		
	XS	STD	STD	SCH. 10	SCH. 5
in	psi	psi	psi	psi	psi
mm	Bar	Bar	Bar	Bar	Bar
1-1/2 x 1-1/4	500	500	500	350	300
40 x 32	35	35	35	24	20
2 x 1-1/2	500	500	500	350	300
50 x 40	35	35	35	24	20
2-1/2 x 2	500	500	500	350	300
65 x 50	35	35	35	24	20
3 x 2	500	500	500	350	300
80 x 50	35	35	35	24	20
3 x 2-1/2	500	500	500	350	300
80 x 65	35	35	35	24	20
4 x 2	500	500	500	350	300
100 x 50	35	35	35	24	20
4 x 2-1/2	500	500	500	350	300
100 x 65	35	35	35	24	20
4 x 3	500	500	500	300	250
100 x 80	35	35	35	20	17
5 x 4	400	400	400	300	250
125 x 100	28	28	28	20	17
6 x 3	400	400	400	300	200
150 x 80	28	28	28	20	14
6 x 4	400	400	400	300	175
150 x 100	28	28	28	20	12
8 x 6	400	400	400	300	175
200 x 150	28	28	28	20	12

MODEL 7706 ON STAINLESS STEEL PIPE

NOM. SIZE	CUT-GROOVED		ROLL-GROOVED		
	SCH. 80S	SCH. 40S	SCH. 40S	SCH. 10S	SCH. 5S
in	psi	psi	psi	psi	psi
mm	Bar	Bar	Bar	Bar	Bar
1-1/2 x 1-1/4	500	350	350	300	250
40 x 32	35	24	24	20	17
2 x 1-1/2	500	350	350	300	250
50 x 40	35	24	24	20	17
2-1/2 x 2	500	350	350	300	250
65 x 50	35	24	24	20	17
3 x 2	500	350	350	300	250
80 x 50	35	24	24	20	17
3 x 2-1/2	500	350	350	300	250
80 x 65	35	24	24	20	17
4 x 2	500	350	350	300	250
100 x 50	35	24	24	20	17
4 x 2-1/2	500	350	350	300	200
100 x 65	35	24	24	20	14
4 x 3	500	300	300	250	200
100 x 80	35	20	20	17	14
5 x 4	400	300	300	250	NR
125 x 100	28	20	20	17	NR
6 x 3	400	300	300	200	NR
150 x 80	28	20	20	14	NR
6 x 4	400	300	300	175	NR
150 x 100	28	20	20	12	NR
8 x 6	400	300	300	175	NR
200 x 150	28	20	20	12	NR

MODEL XH-1000 ON CARBON STEEL PIPE

NOM. SIZE	CUT-GROOVED		ROLL-GROOVED	
	XS	STD	STD	SCH. 10
in	psi	psi	psi	psi
mm	Bar	Bar	Bar	Bar
2	1000	1000	1000	750
50	69	69	69	52
2-1/2	1000	1000	1000	700
65	69	69	69	48
3	1000	1000	1000	600
80	69	69	69	42
4	1000	1000	1000	600
100	69	69	69	42
6	1000	1000	1000	450
150	69	69	69	31
8	800	800	800	350
200	55	55	55	24
10	800	800	800	300
250	55	55	55	20
12	800	800	800	300
300	55	55	55	20

MODEL XH-1000 ON STAINLESS STEEL PIPE

NOM. SIZE	CUT-GROOVED		ROLL-GROOVED	
	SCH. 80S	SCH. 40S	SCH. 40S	SCH. 10S
in	psi	psi	psi	psi
mm	Bar	Bar	Bar	Bar
2	1000	750	750	700
50	69	52	52	48
2-1/2	1000	750	750	700
65	69	52	52	48
3	1000	750	750	500
80	69	52	52	34
4	1000	750	750	500
100	69	52	52	34
6	1000	750	750	350
150	69	52	52	24
8	800	650	650	350
200	55	45	45	24
10	800	600	600	300
250	55	41	41	21
12	800	600	600	300
300	55	41	41	21

MODEL G28 ON CARBON STEEL PIPE

NOM. SIZE	CUT-GROOVED		ROLL-GROOVED	
	XS	STD	STD	SCH. 10
in	psi	psi	psi	psi
mm	Bar	Bar	Bar	Bar
1-1/2	300	300	300	300
40	20	20	20	20
2	300	300	300	300
50	20	20	20	20
2-1/2	300	300	300	300
65	20	20	20	20
3	300	300	300	300
80	20	20	20	20
4	300	300	300	300
100	20	20	20	20
5	300	300	300	300
125	20	20	20	20
6	300	300	300	300
150	20	20	20	20
8	300	300	300	250
200	20	20	20	17
10	300	300	300	250
250	20	20	20	17

MODEL G28 ON STAINLESS STEEL PIPE

NOM. SIZE	CUT-GROOVED		ROLL-GROOVED	
	SCH. 80S	SCH. 40S	SCH. 40S	SCH. 10S
in	psi	psi	psi	psi
mm	Bar	Bar	Bar	Bar
1-1/2	300	300	300	300
40	20	20	20	20
2	300	300	300	300
50	20	20	20	20
2-1/2	300	300	300	300
65	20	20	20	20
3	300	300	300	300
80	20	20	20	20
4	300	300	300	175
100	20	20	20	12
5	300	300	250	150
125	20	20	17	10
6	300	300	250	150
150	20	20	17	10
8	300	300	200	NR
200	20	20	14	
10	300	300	200	NR
250	20	20	14	

MODEL C-7 ON CARBON STEEL PIPE

NOM. SIZE	CUT-GROOVED		ROLL-GROOVED		
	XS	STD	STD	SCH. 10	SCH. 5
in	psi	psi	psi	psi	psi
mm	Bar	Bar	Bar	Bar	Bar
1-1/2 x *	500	500	500	350	250
40 x *	35	35	35	24	17
2 x *	500	500	500	350	250
50 x *	35	35	35	24	17
2-1/2 x *	500	500	500	350	250
65 x *	35	35	35	24	17
3 x *	500	500	500	350	250
80 x *	35	35	35	24	17
4 x *	500	500	500	350	250
100 x *	35	35	35	24	17
6 x *	400	400	400	350	250
150 x *	28	28	28	24	17

* = all branch sizes, threaded and grooved

MODEL C-7 ON STAINLESS STEEL PIPE

NOM. SIZE	CUT-GROOVED		ROLL-GROOVED		
	SCH. 80S	SCH. 40S	SCH. 40S	SCH. 10S	SCH. 5S
in	psi	psi	psi	psi	psi
mm	Bar	Bar	Bar	Bar	Bar
1-1/2 x *	500	500	350	300	250
40 x *	35	35	24	20	17
2 x *	500	500	350	300	250
50 x *	35	35	24	20	17
2-1/2 x *	500	500	350	300	250
65 x *	35	35	24	20	17
3 x *	500	500	350	300	250
80 x *	35	35	24	20	17
4 x *	500	500	350	300	250
100 x *	35	35	24	20	17
6 x *	400	400	300	300	250
150 x *	28	28	20	20	17

* = all branch sizes, threaded and grooved

MODEL 7041 ON CARBON STEEL PIPE

NOM. SIZE	CUT-GROOVED		ROLL-GROOVED		
	XS	STD	STD	SCH. 10	SCH. 5
in	psi	psi	psi	psi	psi
mm	Bar	Bar	Bar	Bar	Bar
2	300	300	300	250	175
50	20	20	20	17	12
2-1/2	300	300	300	250	175
65	20	20	20	17	12
3	300	300	300	250	175
80	20	20	20	17	12
4	300	300	300	250	175
100	20	20	20	17	12
5	300	300	300	250	175
125	20	20	20	17	12
6	300	300	300	250	125
150	20	20	20	17	9
8	300	300	300	200	NR
200	20	20	20	14	
10	300	300	300	200	NR
250	20	20	20	14	
12	300	300	300	200	NR
300	20	20	20	14	
14	300	300	300	200	NR
350	20	20	20	14	
16	300	300	300	175	NR
400	20	20	20	12	
18	300	300	300	175	NR
450	20	20	20	12	
20	300	300	300	150	NR
500	20	20	20	10	
24	300	300	300	150	NR
600	20	20	20	10	

MODEL 7041 ON STAINLESS STEEL PIPE

NOM. SIZE	CUT-GROOVED		ROLL-GROOVED		
	SCH. 80S	SCH. 40S	SCH. 40S	SCH. 10S	SCH. 5S
in	psi	psi	psi	psi	psi
mm	Bar	Bar	Bar	Bar	Bar
2	300	300	275	275	175
50	20	20	19	19	12
2-1/2	300	300	275	275	175
65	20	20	19	19	12
3	300	300	275	275	175
80	20	20	19	19	12
4	300	300	275	275	175
100	20	20	19	19	12
5	300	300	275	200	175
125	20	20	19	14	12
6	300	300	250	200	125
150	20	20	17	14	9
8	300	300	200	75	NR
200	20	20	14	5	
10	300	300	200	75	NR
250	20	20	14	5	
12	300	300	200	50	NR
300	20	20	14	3.5	
14	250	250	125	NR	NR
350	17	17	9		
16	250	250	125	NR	NR
400	17	17	9		
18	250	250	125	NR	NR
450	17	17	9		
20	250	250	100	NR	NR
500	17	17	7		
24	250	250	100	NR	NR
600	17	17	7		

MODEL 7043 ON CARBON STEEL PIPE

NOM. SIZE	CUT-GROOVED		ROLL-GROOVED	
	XS	STD	STD	SCH. 10
in	psi	psi	psi	psi
mm	Bar	Bar	Bar	Bar
2	750	750	750	500
50	52	52	52	35
2-1/2	750	750	750	500
65	52	52	52	35
3	750	750	750	500
80	52	52	52	35
4	750	750	750	500
100	52	52	52	35
5	750	750	750	450
125	52	52	52	31
6	750	750	750	450
150	52	52	52	31
8	750	750	750	300
200	52	52	52	20
10	750	750	750	300
250	52	52	52	20
12	750	750	750	250
300	52	52	52	17

Hydrostatic shell test: 1125 psi (77 Bar) per ANSI B16.5

MODEL 7043 ON STAINLESS STEEL PIPE

NOM. SIZE	CUT-GROOVED		ROLL-GROOVED	
	SCH. 80S	SCH. 40S	SCH. 40S	SCH. 10S
in	psi	psi	psi	psi
mm	Bar	Bar	Bar	Bar
2	400	400	400	275
50	28	28	28	19
2-1/2	400	400	400	275
65	28	28	28	19
3	400	400	400	275
80	28	28	28	19
4	300	300	300	275
100	20	20	20	19
5	300	300	250	200
125	20	20	31	14
6	300	300	200	200
150	20	20	14	14
8	250	250	150	75
200	17	17	10	5
10	250	250	150	75
250	17	17	10	5
12	250	250	150	50
300	17	17	10	3



13# 772

29# 772

4\"/>底座

28# 772

5\"/>底座

#771

5\"/>底座

42# 7110

5\"/>底座



**cast & wrought
grooved fittings**

Shurjoint offers a wide range of grooved-end fittings in sizes 1" (25mm) through 24" (600 mm). Fittings are available in a number of styles and configurations to support a variety of applications. Shurjoint grooved-end fittings are manufactured and designed to meet ASTM F1548 and ANSI/AWWA C606 requirements for use with grooved mechanical couplings conforming to ASTM F1476. For sizes not specified in these standards, please refer to applicable groove specifications shown in this catalog.

Most fittings are provided in ductile iron conforming to ASTM A536 Gr. 65-45-12 and or ASTM A395 Gr. 65-45-15. Some styles and sizes larger than 14" (350 mm) are fabricated from carbon steel pipe to ASTM A53 Gr. B or fabricated of segmentally welded steel of the same or equivalent grade. Fittings are painted orange or as an option can be supplied hot-dip galvanized or epoxy coated.



FLOW DATA / FRICTIONAL RESISTANCE EXPRESSED AS EQUIVALENT LENGTH OF STRAIGHT PIPE

NOMINAL SIZE	PIPE O.D.	PIPE WALL THICKNESS	ELBOWS					TEES	
			#7110 90° STD. RADIUS	#901 90° SHORT RADIUS	#7110LR 90° 1-1/2 D. LR	#7111 45° STD. RADIUS	#7111LR 45° 1-1/2 D. LR	#7120 BRANCH	#903 BRANCH
			feet	feet	feet	feet	feet	feet	feet
in	in	in	meters	meters	meters	meters	meters	meters	
mm	mm	mm	feet	feet	feet	feet	feet	feet	
1	1.315	0.133	1.7	---	---	0.8	---	4.2	---
25	33.4	3.4	0.5	---	---	0.2	---	1.3	---
1-1/4	1.660	0.140	2.5	2.5	---	1.0	---	4.7	4.7
32	42.2	3.6	0.8	0.8	---	0.3	---	1.4	1.4
1-1/2	1.900	0.154	3.5	3.5	---	1.5	---	6.5	6.5
40	48.3	4.0	1.1	1.1	---	0.5	---	2.0	2.0
2	2.375	0.203	4.0	4.0	2.5	1.7	1.1	8.5	8.5
50	60.3	5.2	1.2	1.2	0.8	0.5	0.3	2.6	2.6
2-1/2	2.875	0.197	4.5	4.5	2.9	2.0	1.4	10.0	10.0
65	73.0	5.0	1.4	1.4	0.9	0.6	0.4	3.1	3.1
3	3.500	0.237	5.0	5.0	3.8	2.5	1.5	12.0	12.0
80	88.9	6.3	1.5	1.5	1.2	0.8	0.5	3.7	3.7
4	4.500	0.220	6.7	6.7	5.0	3.0	2.1	15.0	15.0
100	114.3	5.6	2.0	2.0	1.5	0.9	0.6	4.6	4.6
5	5.563	0.258	7.5	7.5	6.0	4.0	2.5	19.0	19.0
125	141.3	6.6	2.3	2.3	1.8	1.2	0.6	5.8	5.8
6	6.625	0.280	9.0	9.0	7.5	4.5	3.0	22.0	22.0
150	168.3	7.1	2.7	2.7	2.3	1.4	0.9	6.7	6.7
8	8.625	0.322	13.0	13.0	9.8	6.5	4.0	33.0	33.0
200	219.1	8.2	4.0	4.0	3.0	2.0	1.2	10.1	10.1
10	10.750	0.365	17.0	---	12.0	8.3	5.0	41.0	---
250	273.0	8.8	5.2	---	3.7	2.5	1.5	12.5	---
12	12.750	0.375	20.0	---	14.5	10.0	6.0	49.0	---
300	323.9	9.5	6.1	---	4.4	3.1	1.8	14.9	---
14	14.000	0.375	24.5	22.3	---	13.8	---	69.9	69.9
350	355.6	9.5	7.5	6.8	---	4.8	---	21.3	21.3
16	16.000	0.375	28.0	25.3	---	15.8	---	80.0	80.0
400	406.4	9.5	8.5	7.7	---	4.8	---	24.4	24.4
18	18.000	0.375	31.0	28.2	---	18.7	---	89.9	89.9
450	457.2	9.5	9.5	8.6	---	5.7	---	27.4	27.4
20	20.000	0.375	34.0	30.8	---	20.9	---	100.0	100.0
500	508.0	9.5	10.4	9.4	---	6.3	---	30.5	30.5
24	24.000	0.375	42.0	37.7	---	24.2	---	120.0	120.0
600	609.6	9.5	12.8	11.5	---	7.4	---	36.6	36.6

The values listed in this table express the frictional resistance of representative Shurjoint fittings as equivalent feet (meters) of straight pipe. For the branch of a tee that is reduced in size, use the value that corresponds to the branch size. For example, the branch value of a 4" x 4" x 3" tee is 12.0 feet (3.7 meters). For fittings not listed in this table, the equivalent length of straight pipe can be estimated from the data provided. For example, the flow resistance of a 22-1/2" elbow is approximately one half that of a 45" elbow.

GROOVED ELBOWS



7110 90° Elbow, regular radius
7111 45° Elbow, regular radius

7112 22-1/2° Elbow
7113 11-1/4° Elbow



Shurjoint grooved-end elbows are made of ductile iron per ASTM A536 Gr. 65-45-12 and or ASTM A395 Gr. 65-45-15. C-E dimensions are manufacturer's standard.

Shurjoint standard fitting pressure ratings conform to the ratings of Model 7707 couplings.

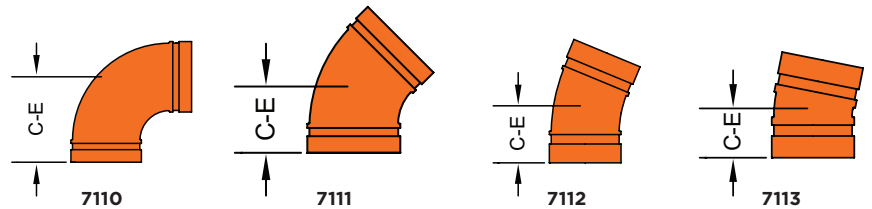
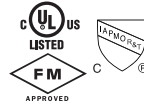

DIMENSIONS

NOMINAL SIZE	PIPE O.D.	7110 90° ELBOW		7111 45° ELBOW		7112 22-1/2° ELBOW		#7113 11-1/4° ELBOW	
		C - E	WEIGHT	C - E	WEIGHT	C - E	WEIGHT	C - E	WEIGHT
in	in	in	lb	in	lb	in	lb	in	lb
mm	mm	mm	kg	mm	kg	mm	kg	mm	kg
1	1.315	2.25	0.7	1.75	0.5	---	---	1.38	0.4
25	33.4	57	0.3	45	0.2	---	---	35	0.2
1-1/4	1.66	2.75	1.1	1.75	0.7	1.75	0.7	1.38	0.7
32	42.2	70	0.5	45	0.3	45	0.3	35	0.3
1-1/2	1.900	2.75	1.3	1.75	0.9	1.75	1.1	1.38	0.7
40	48.3	70	0.6	45	0.4	45	0.5	35	0.3
2	2.375	3.25	2.0	2.00	1.5	1.88	1.6	1.38	1.0
50	60.3	83	0.9	51	0.7	48	0.7	35	0.4
2-1/2	2.875	3.75	2.6	2.25	2.1	2.01	2.6	1.50*	1.6
65	73.0	95	1.2	57	0.9	51	1.2	38	0.7
3	3.50	4.25	4.3	2.50	2.9	2.25	3.1	1.50	1.8
80	88.9	108	2.0	64	1.3	57	1.4	38	0.8
4	4.50	5.00	6.9	3.00	4.4	2.88	4.4	1.75	2.2
100	114.3	127	3.1	76	2.0	73	2.0	45	1.0
5	5.563	5.50	11.0	3.25	6.6	2.88**	6.8	2.00	4.5
125	141.3	140	5.0	83	3.0	73	3.1	51	2.1
6	6.625	6.50	12.8	3.50	8.9	3.12	9.3	2.00	5.5
150	168.3	165	5.8	89	4.0	79	4.2	51	2.5
8	8.625	7.75	28.7	4.25	19.0	3.88	17.8	2.00	10.1
200	219.1	197	13.0	108	8.6	98	8.1	51	4.6
10	10.75	9.00	53.1	4.75	34.2	4.38	39.0	2.13	22.1
250	273.0	229	24.1	121	15.5	111	17.7	54	10.0
12	12.750	10.00	81.0	5.25	49.5	4.88	43.0	2.25	27.3
300	323.9	254	36.7	133	22.5	124	19.5	57	12.4

*Non-standard/stock items may require longer lead time.

**Model is fabricated from carbon steel A53 or A234 Gr. WPB standard wall fitting.

GROOVED FITTINGS

7120 Tee | 7135 Cross
 7130 45° Lateral



Shurjoint grooved-end fittings are made of ductile iron per ASTM A536 Gr. 65-45-12 and or ASTM A395 Gr. 65-45-15. C-E dimensions are manufacturer's standard.

Shurjoint standard fitting pressure ratings conform to the ratings of Model 7707 couplings.

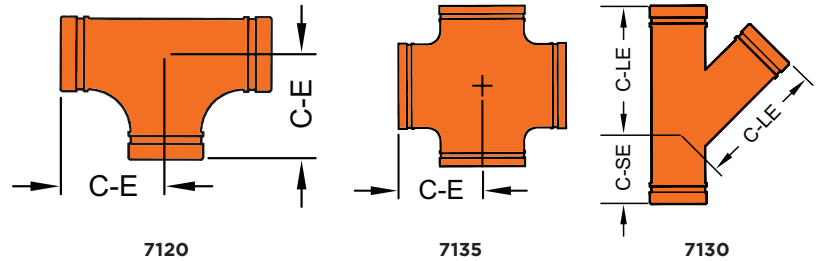
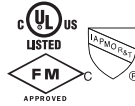

DIMENSIONS

NOMINAL SIZE	PIPE O.D.	7120 TEE		7135 CROSS		7130 45° LATERAL		
		C - E	WEIGHT	C - E	WEIGHT	C - LE	C - SE	WEIGHT
in	in	in	lb	in	lb	in	in	lb
mm	mm	mm	kg	mm	kg	mm	mm	kg
1	1.315	2.25	0.9	2.25**	1.3	---	---	---
25	33.4	57	0.4	57	0.63	---	---	---
1-1/4	1.660	2.75	1.5	2.75	1.65	---	---	---
32	42.2	70	0.7	70	0.75	---	---	---
1-1/2	1.900	2.75	2.0	2.75	1.9	---	---	---
40	48.3	70	0.9	70	0.87	---	---	---
2	2.375	3.25	2.9	3.25	2.7	7.00	2.75	4.4
50	60.3	83	1.3	83	1.2	178	70	2.0
2-1/2	2.875	3.75	4.8	3.75	6.6	7.75	3.00	6.2
65	73.0	95	2.2	95	3.0	197	76	2.8
3	3.500	4.25	6.8	4.25	6.8	8.50	3.25	9.2
80	88.9	108	3.1	108	3.1	216	83	4.2
4	4.500	5.00	9.9	5.00	11.5	10.50	3.75	17.6
100	114.3	127	4.5	127	5.2	267	95	8.0
5	5.563	5.50	14.3	5.50	13.0	12.50	4.00	27.5
125	141.3	140	6.5	140	5.9	318	102	12.5
6	6.250	6.50	18.9	---	---	---	---	---
150	159.0	165	8.6	---	---	---	---	---
6	6.625	6.50	22.0	6.50	32.0	14.00	4.50	40.7
150	168.3	165	10.0	165	14.5	356	114	18.5
8	8.625	7.75	44.0	7.75	44.1	18.00	6.00	70.4
200	219.1	197	20.0	197	20.0	457	152	32.0
10	10.750	9.00	68.2	9.01	7.55	20.50	6.50	138.9
250	273.0	229	31.0	229	3.42	521	165	63.0
12	12.750	10.00	96.7	10.00	11.23	23.00	7.00	201.7
300	323.9	254	43.9	254	5.1	584	178	91.5
14	14.000	11.00	114.6	11.02	---	---	---	---
350	355.6	280	52.0	280	---	---	---	---

*Non-standard/stock items may require longer lead time.

**Model is fabricated from carbon steel A53 or A234 Gr. WPB standard wall fitting.¹

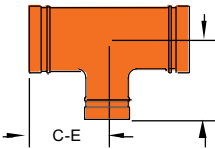
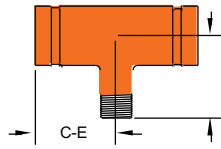
7121

**7121
MALE THREADS**

Shurjoint grooved-end reducing tees are made of ductile iron per ASTM A536 Gr. 65-45-12 and or ASTM A395 Gr. 65-45-15. C-E dimensions are manufacturer's standard.

For sizes larger than 14" (350 mm) are fabricated from standard weight (0.375" or 9.5 mm) carbon steel pipe to ASTM A234 GR. WPB or segmentally welded with carbon steel of the same or equivalent grade. C-E & C-B dimensions conform to ANSI B16.9.

Shurjoint standard fitting pressure ratings conform to the ratings of Model 7707 couplings.

For Fire Protection pressure rating, listing, and approval information, refer to Data Sheet B-42 or visit www.shurjoint.com for details or contact Shurjoint.

DIMENSIONS

NOMINAL SIZE	PIPE O.D.	STANDARD C - E	THREADED BR. C - E	WEIGHT
in	in	in	in	lb
mm	mm	mm	mm	kg
2 x 2 x 1-1/4	2.375 x 2.375 x 1.660	3.25	---	2.6
50 x 50 x 32	60.3 x 60.3 x 42.2	83	---	1.2
2 x 2 x 1-1/2	2.375 x 2.375 x 1.900	3.25	3.25*	2.6
50 x 50 x 40	60.3 x 60.3 x 48.3	83	83	1.2
2-1/2 x 2-1/2 x 1	2.875 x 2.875 x 1.315	3.75	3.75	3.7
65 x 65 x 25	73.0 x 73.0 x 33.4	95	95	1.7
2-1/2 x 2-1/2 x 1-1/4	2.875 x 2.875 x 1.660	3.75	3.75	3.7
65 x 65 x 32	73.0 x 73.0 x 42.2	95	95	1.7
2-1/2 x 2-1/2 x 1-1/2	2.875 x 2.875 x 1.900	3.75	3.75	4.0
65 x 65 x 40	73.0 x 73.0 x 48.3	95	95	1.8
2-1/2 x 2-1/2 x 2	2.875 x 2.875 x 2.375	3.75	3.75	4.4
65 x 65 x 50	73.0 x 73.0 x 60.3	95	95	2.0
3 x 3 x 1	3.500 x 3.500 x 1.315	4.25	4.25*	5.5
80 x 80 x 25	88.9 x 88.9 x 33.4	108	108	2.5
3 x 3 x 1-1/4	3.500 x 3.500 x 1.660	4.25	4.25*	5.2
80 x 80 x 32	88.9 x 88.9 x 42.2	108	108	2.4
3 x 3 x 1-1/2	3.500 x 3.500 x 1.900	4.25	4.25	5.2
80 x 80 x 40	88.9 x 88.9 x 48.3	108	108	2.4
3 x 3 x 2	3.500 x 3.500 x 2.375	4.25	4.25	6.2
80 x 80 x 50	88.9 x 88.9 x 60.3	108	108	2.8
3 x 3 x 2-1/2	3.500 x 3.500 x 2.875	4.25	4.25	6.2
80 x 80 x 65	88.9 x 88.9 x 73.0	108	108	2.8
4 x 4 x 1	4.500 x 4.500 x 1.315	5.00	5.00	8.9
100 x 100 x 25	114.3 x 114.3 x 33.4	127	127	4.0
4 x 4 x 1-1/2	4.500 x 4.500 x 1.900	5.00	5.00	9.3
100 x 100 x 40	114.3 x 114.3 x 48.3	127	127	4.2

NOMINAL SIZE	PIPE O.D.	STANDARD C - E	THREADED BR. C - E	WEIGHT
4 x 4 x 2	4.500 x 4.500 x 2.375	5.00	5.00	8.8
100 x 100 x 50	114.3 x 114.3 x 60.3	127	127	4.0
4 x 4 x 2-1/2	4.500 x 4.500 x 2.875	5.00	5.00	9.5
100 x 100 x 65	114.3 x 114.3 x 73.0	127	127	4.3
4 x 4 x 3	4.500 x 4.500 x 3.500	5.00	5.00	9.4
100 x 100 x 80	114.3 x 114.3 x 88.9	127	127	4.3
5x5x2	5.563 x 5.563 x 2.375	5.50	5.50*	12.4
125 x 125 x 50	141.3 x 141.3 x 60.3	140	140	5.6
5 x 5 x 2-1/2	5.563 x 5.563 x 2.875	5.50	5.50*	12.8
125 x 125 x 65	141.3 x 141.3 x 73.0	140	140	5.8
5 x 5 x 3	5.563 x 5.563 x 3.500	5.50	5.50*	12.6
125 x 125 x 80	141.3 x 141.3 x 88.9	140	140	5.7
5 x 5 x 4	5.563 x 5.563 x 4.500	5.50	5.50*	13.6
125 x 125 x 100	141.3 x 141.3 x 114.3	140	140	6.2
6 x 6 x 2	6.625 x 6.625 x 2.375	6.50	6.50	17.6
150 x 150 x 50	168.3 x 168.3 x 60.3	165	165	8.0
6 x 6 x 2-1/2	6.625 x 6.625 x 2.875	6.50	6.50*	18.7
150 x 150 x 65	168.3 x 168.3 x 73.0	165	165	8.5
6 x 6 x 3	6.625 x 6.625 x 3.500	6.50	6.50*	20.2
150 x 150 x 80	168.3 x 168.3 x 88.9	165	165	9.2
6 x 6 x 4	6.625 x 6.625 x 4.500	6.50	6.50*	19.4
150 x 150 x 100	168.3 x 168.3 x 114.3	165	165	8.8

DIMENSIONS

NOMINAL SIZE	PIPE O.D.	STANDARD C - E	THREADED BR. C - E	WEIGHT
8 x 8 x 2	8.625 x 8.625 x 2.375	7.75	7.75	32.5
200 x 200 x 50	219.1 x 219.1 x 60.3	197	17	14.8
8 x 8 x 2-1/2	8.625 x 8.625 x 2.875	7.75	---	31.9
200 x 200 x 65	219.1 x 219.1 x 73.0	197	---	14.5
8 x 8 x 3	8.625 x 8.625 x 3.500	7.75	7.75	34.2
200 x 200 x 80	219.1 x 219.1 x 88.9	197	197	15.5
8 x 8 x 4	8.625 x 8.625 x 4.500	7.75	7.75	44.0
200 x 200 x 100	219.1 x 219.1 x 114.3	197	197	20.0
8 x 8 x 6	8.625 x 8.625 x 6.625	7.75	---	46.2
200 x 200 x 150	219.1 x 219.1 x 168.3	197	---	21.0
10 x 10 x 4	10.750 x 10.750 x 4.500	9.00	9.00	62.8
250 x 250 x 100	273.0 x 273.0 x 114.3	229	229	28.5
10 x 10 x 6	10.750 x 10.750 x 6.625	9.00	---	66.0
250 x 250 x 150	273.0 x 273.0 x 168.3	229	---	30.0

NOMINAL SIZE	PIPE O.D.	STANDARD C - E	THREADED BR. C - E	WEIGHT
10 x 10 x 8	10.750 x 10.750 x 8.625	9.00	---	69.3
250 x 250 x 200	273.0 x 273.0 x 219.1	229	---	31.5
12 x 12 x 3	12.750 x 12.750 x 3.500	10.00	10.00*	88.1
300 x 300 x 80	323.9 x 323.9 x 88.9	254	254	40.0
12 x 12 x 4	12.750 x 12.750 x 4.500	10.00	10.00*	90.4
300 x 300 x 100	323.9 x 323.9 x 114.3	254	254	41.0
12 x 12 x 6	12.750 x 12.750 x 6.625	10.00	---	83.6
300 x 300 x 150	323.9 x 323.9 x 168.3	254	---	38.0
12 x 12 x 8	12.750 x 12.750 x 8.625	10.00	---	83.6
300 x 300 x 200	323.9 x 323.9 x 219.1	254	---	38.0
12 x 12 x 10	12.750 x 12.750 x 10.750	10.00	---	88.0
300 x 300 x 250	323.9 x 323.9 x 273.0	254	---	40.0

REDUCERS

7150 Concentric reducer
7151 Eccentric reducer

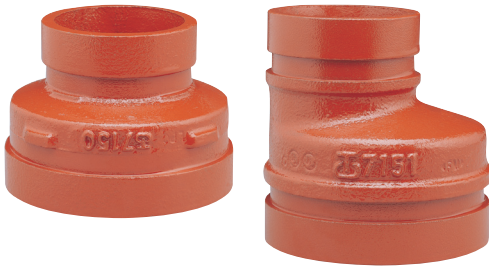

Shurjoint grooved-end reducers are made of ductile iron per ASTM A536 Gr. 65-45-12 and or ASTM A395 Gr. 65-45-15. C-E dimensions are manufacturer's standard.

For sizes larger than 14" (350 mm) are fabricated from standard weight (0.375" or 9.5 mm) carbon steel pipe to ASTM A234 GR. WPB or segmentally welded with carbon steel of the same or equivalent grade. E-E dimensions conform to ANSI B16.9.



7150



7151

DIMENSIONS

NOMINAL SIZE	PIPE O.D.	#7150 CONC.REDUCER		#7151 ECC.REDUCER	
		E-E	WEIGHT	E-E	WEIGHT
in	in	in	lb	in	lb
mm	mm	mm	kg	mm	kg
1-1/4 x 1	1.660 x 1.315	2.50	0.4	---	---
32 x 25	42.2 x 33.4	63.5	0.2	---	---
1-1/2 x 1	1.900 x 1.315	2.50	0.5	---	---
40 x 25	48.3 x 33.4	63.5	0.2	---	---
1-1/2 x 1-1/4	1.900 x 1.660	2.50	0.6	---	---
40 x 32	48.3 x 42.2	63.5	0.3	---	---
2 x 1	2.375 x 1.315	2.50	0.9	---	---
50 x 25	60.3 x 33.4	63.5	0.4	---	---
2 x 1-1/4	2.375 x 1.660	2.50	0.7	---	---
50 x 32	60.3 x 33.4	63.5	0.3	---	---
2 x 1-1/2	2.375 x 1.900	2.50	0.7	---	---
50 x 40	60.3 x 48.3	63.5	0.4	---	---
2-1/2 x 1	2.875 x 1.315	2.50	0.9	---	---
65 x 25	73.0 x 33.4	63.5	0.4	---	---
2-1/2 x 1-1/4	2.875 x 1.660	2.50	1.1	---	---
65 x 32	73.0 x 33.4	63.5	0.5	---	---
2-1/2 x 1-1/2	2.875 x 1.900	2.50	1.1	---	---
65 x 40	73.0 x 48.3	63.5	0.5	---	---
2-1/2 x 2	2.875 x 2.375	2.50	1.1	3.50	1.5
65 x 50	73.0 x 60.3	63.5	0.5	89.0	0.7
3 x 1	3.500 x 1.315	2.50	1.3	---	---
80 x 25	88.9 x 33.4	63.5	0.6	---	---
3 x 1-1/4	3.500 x 1.660	2.50	1.3	---	---
80 x 32	88.9 x 33.4	63.5	0.6	---	---
3 x 1-1/2	3.500 x 1.900	2.50	1.3	---	---
80 x 40	88.9 x 48.3	63.5	0.6	---	---
3 x 2	3.500 x 2.375	2.50	1.3	3.50	2.2
80 x 50	88.9 x 60.3	63.5	0.6	89.0	1.0
3 x 2-1/2	3.500 x 2.875	2.50	1.3	3.50	2.2
80 x 65	88.9 x 73.0	63.5	0.6	89.0	1.0
**4 x 1	4.500 x 1.315	**3.00	2.4	---	---
100 x 25	114.3 x 33.4	76	1.1	---	---
4 x 1-1/4	4.500 x 1.660	3.00	2.2	---	---
100 x 32	114.3 x 33.4	76	1.0	---	---
4 x 1-1/2	4.500 x 1.900	3.00	2.2	---	---
100 x 40	114.3 x 48.3	76	1.0	---	---
4 x 2	4.500 x 2.375	3.00	2.0	4.00	2.8
100 x 50	114.3 x 60.3	76	0.9	102	1.3
4 x 2-1/2	4.500 x 2.875	3.00	2.2	4.00	3.3
100 x 65	114.3 x 73.0	76	1.0	102	1.5

** Model is fabricated from carbon steel A53 or A234 Gr. WPB standard wall fitting.

NOMINAL SIZE	PIPE O.D.	#7150 CONC.REDUCER		#7151 ECC.REDUCER	
		E-E	WEIGHT	E-E	WEIGHT
in	in	in	lb	in	lb
mm	mm	mm	kg	mm	kg
4 x 3	4.500 x 3.500	3.00	2.2	4.00	2.8
100 x 80	114.3 x 88.9	76	1.0	102	1.3
5 x 3	5.563 x 3.500	3.50	3.3	4.00	5.3
125 x 80	141.3 x 88.9	89	1.5	102	2.4
5 x 4	5.563 x 4.500	3.50	3.5	4.00	6.2
125 x 100	141.3 x 114.3	89	1.6	102	2.8
6 x 2	6.625 x 2.375	4.00	4.2	4.00	4.4
150 x 50	168.3 x 60.3	102	1.9	102	2.0
**6 x 2-1/2	6.625 x 2.875	4.00	4.4	**5.63	6.9
150 x 65	168.3 x 73.0	102	2.00	143	3.1
6 x 3	6.625 x 3.500	4.00	4.4	4.00	7.7
150 x 80	168.3 x 88.9	102	2.00	102	3.5
6 x 4	6.625 x 4.500	4.00	4.6	4.00	6.0
150 x 100	168.3 x 114.3	102	2.1	102	2.7
6 x 5	6.625 x 5.563	4.00	5.5	4.00	9.9
150 x 125	168.3 x 141.3	102	2.5	102	4.5
8 x 2	8.625 x 2.375	5.00	8.4	---	---
200 x 50	219.1 x 60.3	127	3.8	---	---
**8 x 2-1/2	8.625 x 2.875	**5.00	8.4	---	---
200 x 65	219.1 x 73.0	127	3.8	---	---
8 x 3	8.625 x 3.500	5.00	8.4	---	---
200 x 80	219.1 x 88.9	127	3.8	---	---
8 x 5	8.625 x 5.563	5.00	9.5	---	---
200 x 125	219.1 x 141.3	127	4.3	---	---
8 x 4	8.625 x 4.500	5.00	11.2	5.00	14.6
200 x 100	219.1 x 114.3	127	5.1	127	6.6
8 x 6	8.625 x 6.625	5.00	11.5	5.00	10.8
200 x 150	219.1 x 168.3	127	5.2	127	4.9
10 x 4	10.750 x 4.500	6.00	18.7	6.00	26.5
250 x 100	273.0 x 114.3	152	8.5	152	12.0
10 x 6	10.750 x 6.625	6.00	19.8	6.00	25.4
250 x 150	273.0 x 168.3	152	9.0	152	11.5
10 x 8	10.750 x 8.625	6.00	20.9	7.00	26.9
250 x 200	273.0 x 219.1	152	9.5	178	12.2
12 x 6	12.750 x 6.625	7.00	30.9	7.00	39.7
300 x 150	323.9 x 168.3	178	14.0	178	18.0
12 x 8	12.750 x 8.625	7.00	30.9	7.00	40.8
300 x 200	323.9 x 219.1	178	14.0	178	18.5
12 x 10	12.750 x 10.750	7.00	30.2	7.00	44.1
300 x 250	323.9 x 273.0	178	13.7	178	20.0

CAPS

7160 End cap | 7160h domed end cap
 7160p end cap with plug

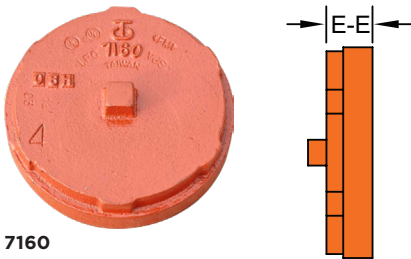

7160

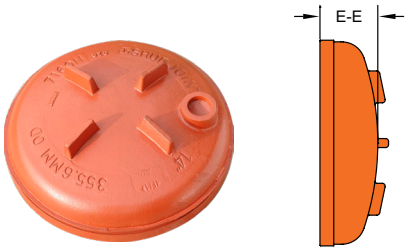

7160H

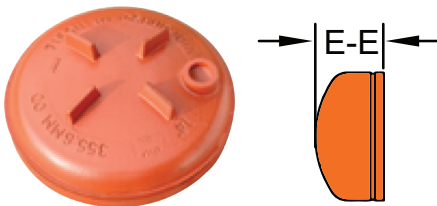

W160

The Model 7160T grooved x threaded transition fitting can be the ideal fitting when transitioning from a larger grooved pipe to a smaller threaded pipe such as 6" x 1", 4" x 1" etc. The 7160T can be used as an alternative to expensive swaged nipples.



DIMENSIONS 7160 / 7160P

NOMINAL SIZE	PIPE O.D.	7160 END CAP		7160P
		E - E	WEIGHT	PLUG SIZE
in	in	in	lb	in
mm	mm	mm	kg	mm
1	1.315	0.87	0.2	---
25	33.4	22	0.1	---
1-1/4	1.660	1.00	0.3	---
32	42.2	25	0.2	---
1-1/2	1.900	1.00	0.4	---
40	48.3	25	0.2	---
2	2.375	1.00	0.7	1/2
50	60.3	25	0.3	15
2-1/2	2.875	1.00	0.9	1/2
65	73.0	25	0.4	15
3	3.500	1.00	1.5	1/2
80	88.9	25	0.7	15
4	4.500	1.00	2.2	1
100	114.3	25	1.0	25
5	5.563	1.00	3.7	1
125	141.3	25	1.7	25
6	6.625	1.00	6.0	1
150	168.3	25	2.7	25
8	8.625	1.18	10.1	1-1/2
200	219.1	30	4.6	40
10	10.750	1.25	15.4	1-1/2
250	273.0	32	7.0	40
12	12.750	1.25	22.0	1-1/2
300	323.9	32	10.0	40

*Non-standard/stock items may require longer lead time.

DIMENSIONS 7160H

NOMINAL SIZE	PIPE O.D.	7160H DOMED END CAP	
		E - E	WEIGHT
in	in	in	lb
mm	mm	mm	kg
10	10.750	3.00	12.1
250	273.0	76.1	5.5
12	12.750	3.00	16.3
300	323.9	76.1	7.4
14	14.000	4.00	26.4
350	355.6	102.0	12.0
16	16.000	4.00	32.0
400	406.4	102.0	14.5
18	18.000	5.00	39.2
450	457.2	127.0	17.8
20	20.000	6.00	53.9
500	508.0	152.0	24.5
24	24.000	6.00	75.9
600	609.6	152.0	34.5
28*	28.000	10.50	125.1
700	711.2	266.6	56.8

*Non-standard/stock items may require longer lead time.

DIMENSIONS W160

NOMINAL SIZE	PIPE O.D.	W160 CAP	
		E - E	WEIGHT
in	in	in	lb
mm	mm	mm	kg
12	12.750	---	---
300	323.9	---	---
14	14.000	6.50	35.0
350	355.6	165.0	15.9
16	16.000	7.00	44.0
400	406.4	178.0	20.0
18	18.000	8.00	56.1
450	457.2	203.0	25.5
20	20.000	9.00	70.0
500	508.0	229.0	31.8
22	22.000	10.00	85.4
550	558.8	254.0	38.8
24	24.000	10.50	99.2
600	609.6	267.0	45.1

The Model 7160T grooved x threaded transition fitting can be the ideal fitting when transitioning from a larger grooved pipe to a smaller threaded pipe such as 6" x 1", 4" x 1" etc. The 7160T can be used as an alternative to expensive swaged nipples.

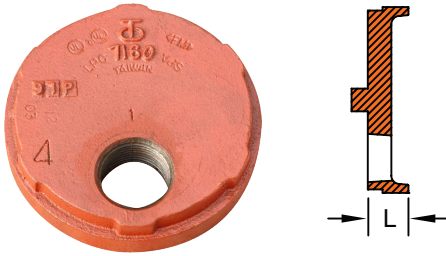

DIMENSIONS

NOMINAL SIZE	NPT / BSP	L	WEIGHT
in	in	in	lb
mm	mm	mm	kg
2 x	1/2" 1" 1-1/4" 1-1/2"	0.94	0.55
50 x	15 25 32 40	23.8	0.25
2-1/2 x	1" 1-1/4" 1-1/2"	0.94	0.97 0.77 0.70
65 x	25 32 40	23.8	0.44 0.35 0.30
3 x	1/2" 1" 1-1/4" 1-1/2" 2"	1.000	1.40 1.43 1.43 1.33 1.33
80 x	15 25 32 40	25.4	0.67 0.65 0.65 0.60 0.60

NOMINAL SIZE	NPT / BSP	L	WEIGHT
in	in	in	lb
mm	mm	mm	kg
4 x	1/2" 1" 1-1/4" 1-1/2" 2"	0.94	2.1 2.1 2.1 2.0 2.0
50x	1/2" 1" 1-1/4" 1-1/2" 2"	23.8	0.95 0.95 0.95 0.90 0.90
5x	1"	1	3.7
125x	25	25.4	1.7
6x	1" 1-1/4" 1-1/2" 2"	1.000	5.7
1500x	25 32 40	25.4	2.6

*Non-standard/stock items may require longer lead time.

7110LR 1.5D 90° ELBOW 7111LR 1.5D 45° ELBOW 7137 TRUE-Y

ASTM A536 Gr. 65-45-12 and or ASTM A395 Gr. 65-45-15. C-E dimensions are manufacturer's standard.

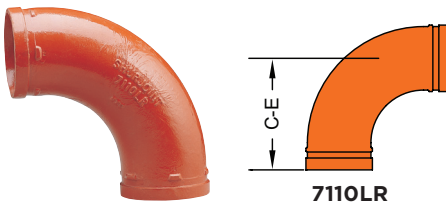

7110LR

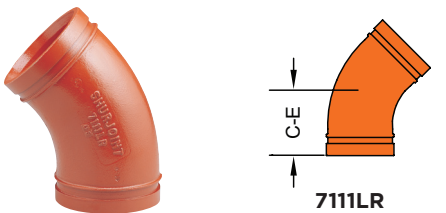

7111LR

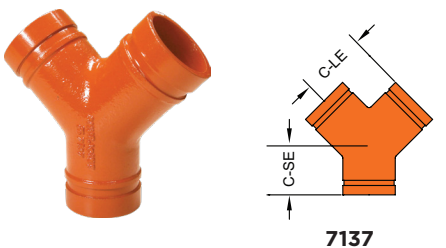

7137

DIMENSIONS

NOMINAL SIZE	PIPE O.D.	7110LR 1.5D 90° ELBOW		7111LR 1.5D 45° ELBOW		7137 TRUE-Y		
		C - E	WEIGHT	C - E	WEIGHT	C - LE	C - SE	WEIGHT
in	in	in	lb	in	lb	in	in	lb
mm	mm	mm	kg	mm	kg	mm	mm	kg
2	2.375	4.38	2.4	2.75	1.8	3.25	2.75	2.5
50	60.3	111	1.1	70	0.8	83	70	1.1
2-1/2	2.875	5.00	4.0	3.00	3.1	3.75	3.00	3.8
65	73.0	127	1.8	76	1.4	95	76	1.7
3	3.500	5.88	5.8	3.38	4.0	4.25	3.25	5.5
80	88.9	149	2.6	86	1.8	108	83	2.5
4	4.500	7.50	10.3	4.00	7.7	5.00	3.75	10.4
100	114.3	191	4.7	102	3.5	127	95	4.7
5	5.563	9.50	18.1	5.00	10.1	5.50	4.00	11.6
125	141.3	241	8.2	127	4.6	140	102	5.3
6	6.625	10.75	25.3	5.50	18.0	6.50	4.50	19.6
150	168.3	273	11.5	140	8.2	165	114	8.9
8	8.625	14.25	50.7	7.25	35.3	7.75	6.00	34.3
200	219.1	362	23.0	184	16.0	197	152	15.6
10	10.750	17.25	73.0	8.50	78.6	9.00**	6.50	56.2
250	273.0	438	42.2	216	36.1	229	165	25.5
12	12.750	20.50	157.6	10.00	73.9	10.00**	7.00	79.4
300	323.9	521	71.5	254	33.5	254	178	36.0

*Non-standard/stock items may require longer lead time.

**Model is fabricated from carbon steel A53 or A234 Gr. WPB standard wall fitting.



WROUGHT GROOVED FITTINGS

W110lr
W111lr

1.5d Long radius 90° elbow
1.5d Long radius 45° elbow

W120
W160

tee
cap

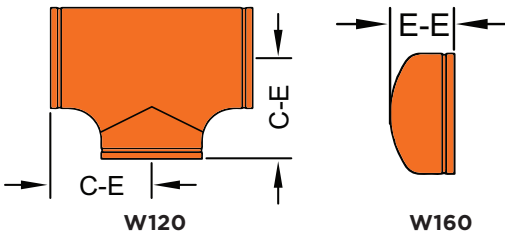
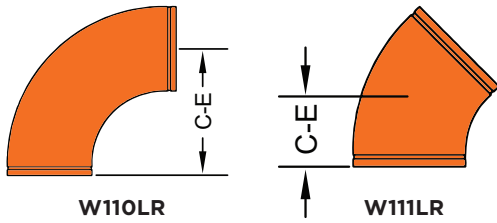

The Shurjoint wrought steel grooved end fittings are available 10" (250 mm) through 42" (1050 mm) pipe sizes in a variety of styles. Fittings are fabricated with the carbon steel pipe to ASTM A234 Gr. WPB, standard weight (0.375" or 9.5 mm), or segmentally welded carbon steel of the same or equivalent grade. Dimensions conform to ANSI B16.9. Other styles not listed are available upon request.

DIMENSIONS

NOMINAL SIZE	PIPE O.D.	W110LR 90° L/R ELBOWS		W111LR 45° L/R ELBOWS		W120 TEE		W160 CAP	
		C-E	WEIGHT	C-E	WEIGHT	C-E	WEIGHT	E-E	WEIGHT
in	in	in	lb	in	lb	in	lb	in	lb
mm	mm	mm	kg	mm	kg	mm	kg	mm	kg
14	14.000	21.00	149.4	8.75	74.8	11.00	110.2	6.50	35.0
350	355.6	533.4	67.9	222.3	34.0	279.4	50.0	165.0	15.9
16	16.000	24.00	195.8	10.00	98.1	12.00	145.4	7.00	44.0
400	406.4	609.6	89.0	254.0	44.6	304.8	66.1	178.0	20.0
18	18.000	27.00	248.6	11.25	124.3	13.50	169.8	8.00	56.1
450	457.2	685.8	113.0	285.5	56.5	342.9	77.0	203.0	25.5
20	20.000	30.00	308.0	12.50	154.0	15.00	209.4	9.00	70.0
500	508.0	762.0	140.0	317.5	70.0	381.0	95.0	229.0	31.8
22	22.000	33.00	371.8	13.50	187.0	16.50	277.2	10.00	85.4
550	558.8	838.2	169.0	342.9	85.0	419.1	126.0	254.0	38.8
24	24.000	36.00	444.4	15.00	222.2	17.00	267.9	10.50	99.2
600	609.6	914.4	202.0	381.0	101.0	431.8	121.5	267.0	45.1
26	26	39	103.6	16	51.7	19.5	71.5	10.5	24.3
650	660.4	990.6	228.5	406.4	114	495.3	157.6	267	53.5
28	28	42	120.1	17.25	59.9	20.5	80.1	10.5	26.9
700	711	1066.8	264.7	438.2	132.1	520.7	176.6	267	59.3
30	30	45	137.7	18.5	68.8	22	92	10.5	29.6
750	762	1143	303.6	469.9	151.6	558.8	202.9	267	65.2
32	32	48	156.5	19.75	78.2	23.5	104.8	10.5	32.3
800	812.8	1219.2	345.1	501.7	172.4	596.9	231	267	71.3
26	26	39	103.6	16	51.7	19.5	71.5	10.5	24.3
650	660.4	990.6	228.5	406.4	114	495.3	157.6	267	53.5
28	28	42	120.1	17.25	59.9	20.5	80.1	10.5	26.9
700	711	1066.8	264.7	438.2	132.1	520.7	176.6	267	59.3
30	30	45	137.7	18.5	68.8	22	92	10.5	29.6
750	762	1143	303.6	469.9	151.6	558.8	202.9	267	65.2
32	32	48	156.5	19.75	78.2	23.5	104.8	10.5	32.3
800	812.8	1219.2	345.1	501.7	172.4	596.9	231	267	71.3
34	34	51	176.6	21	88.2	25	118.4	10.5	35.2
850	863.6	1295.4	389.3	533.4	194.6	635	260.9	267	77.7
36	36	54	197.8	22.25	98.9	26.5	132.8	10.5	38.2
900	914.4	1371.6	436.1	565.2	218.1	673.1	292.7	267	84.2
40	40	60	244.2	24.88	122.7	29.5	164	12	47.8
1000	1016	1524	538.4	632	270.6	749.3	361.6	304.8	105.4
42	42	63	269.1	26	134.6	30.00/28.00	167.6	12	51.2
1050	1066.8	1600.2	593.2	660.4	296.7	762.0/711.2	369.5	304.8	113.0

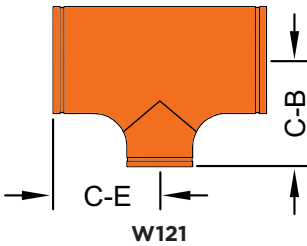

DIMENSIONS

NOMINAL SIZE	PIPE O.D.	W121 REDUCING TEE		WEIGHT
		C - E	C - B	
in mm	in mm	in mm	in mm	lb kg
14 x 6	14.000 x 6.625	11	9.37	101.2
350 x 150	355.6 x 168.3	279	238	46
14 x 8	14.000 x 8.625	11	9.76	102.3
350 x 200	355.6 x 219.1	279	248	46.5
14 x 10	14.000 x 10.750	11	10.12	104.9
350 x 250	355.6 x 273.0	279	257	47.7
14 x 12	14.000 x 12.750	11	10.63	96.8
350 x 300	355.6 x 323.9	279	270	44
16 x 6	16.000 x 6.625	12	10.4	125.8
400 x 150	406.4 x 168.3	305	264	57.2
16 x 8	16.000 x 8.625	12	10.75	127.2
400 x 200	406.4 x 219.1	305	273	57.8
16 x 10	16.000 x 10.750	12	11.14	129.6
400 x 250	406.4 x 273.0	305	283	58.9
16 x 12	16.000 x 12.750	12	11.61	132.2
400 x 300	406.4 x 323.9	305	295	60.1
16 x 14	16.000 x 14.000	12	12	134.4
400 x 350	406.4 x 355.6	305	305	61.1
18 x 6	18.000 x 6.625	13.5	11.38	159.7
450 x 150	457.2 x 168.3	343	289	72.6
18 x 8	18.000 x 8.625	13.5	11.75	160.6
450 x 200	457.2 x 219.1	343	298	73
18 x 10	18.000 x 10.750	13.5	12.13	162.8
450 x 250	457.2 x 273.0	343	308	74
18 x 12	18.000 x 12.750	13.5	12.64	165.2
450 x 300	457.2 x 323.9	343	321	75.1
18 x 14	18.000 x 14.000	13.5	13	167.2
450 x 350	457.2 x 355.6	343	330	76
18 x 16	18.000 x 16.000	13.5	13	167.9
450 x 400	457.2 x 406.4	343	330	76.3
20 x 6	20.000 x 6.625	15	12.36	196.9
500 x 150	508.0 x 168.3	381	314	89.5
20 x 8	20.000 x 8.625	15	12.76	198
500 x 200	508.0 x 219.1	381	324	90
20 x 10	20.000 x 10.750	15	13.11	200
500 x 250	508.0 x 273.0	381	333	90.9
20 x 12	20.000 x 12.750	15	13.62	202.4
500 x 300	508.0 x 323.9	381	346	92
20 x 14	20.000 x 14.000	15	14.02	204.4
500 x 350	508.0 x 355.6	381	356	92.9
20 x 16	20.000 x 16.000	15	14.02	204.6
500 x 400	508.0 x 406.4	381	356	93.6
20 x 18	20.000 x 18.000	15	14.5	207.9
500 x 450	508.0 x 457.2	381	368	94.5
24 x 6	24.000 x 6.625	17	14.38	268.4
600 x 150	609.6 x 168.3	432	365	122
24 x 8	24.000 x 8.625	17	14.76	270.6
600 x 200	609.6 x 219.1	432	375	123
24 x 10	24.000 x 10.750	17	15.12	271
600 x 250	609.6 x 273.0	432	384	123.2
24 x 12	24.000 x 12.750	17	15.63	273.2
600 x 300	609.6 x 323.9	432	397	124.2
24 x 14	24.000 x 14.000	17	16	275
600 x 350	609.6 x 355.6	432	406	125
24 x 16	24.000 x 16.000	17	16	275
600 x 400	609.6 x 406.4	432	406	125
24 x 18	24.000 x 18.000	17	16.5	279.6
600 x 450	609.6 x 457.2	432	419	127.1
24 x 20	24.000 x 20.000	17	17	281.6
600 x 500	609.6 x 508.0	432	432	128
26 x 10	26.000 x 10.750	19.5	16.6	314.4
650 x 250	660.4 x 273.0	495	422	142.9
26 x 12	26.000 x 12.750	19.5	16.6	315.3
650 x 300	660.4 x 323.9	495	422	143.3
26 x 14	26.000 x 14.000	19.5	17	315.9
650 x 350	660.4 x 355.6	495	432	143.6
26 x 16	26.000 x 16.000	19.5	17	315.9
650 x 400	660.4 x 406.4	495	432	143.6

NOMINAL SIZE	PIPE O.D.	W121 REDUCING TEE		WEIGHT
		C - E	C - B	
in mm	in mm	in mm	in mm	lb kg
26 x 18	26.000 x 18.000	19.5	17.5	317.9
650 x 450	660.4 x 457.2	495	444	144.5
26 x 20	26.000 x 20.000	19.5	18	320.1
650 x 500	660.4 x 508.0	495	457	145.9
28 x 12	28.000 x 12.750	20.5	17.62	356.8
700 x 300	711.0 x 323.9	521	448	162.2
28 x 14	28.000 x 14.000	20.5	18	356.8
700 x 350	711.0 x 355.6	521	457	162.2
28 x 16	28.000 x 16.000	20.5	18	356.8
700 x 400	711.0 x 406.4	521	457	162.2
28 x 18	28.000 x 18.000	20.5	18.5	358.6
700 x 450	711.0 x 457.2	521	470	163
28 x 20	28.000 x 20.000	20.5	19	361.5
700 x 500	711.0 x 508.0	521	483	164.3
28 x 22	28.000 x 22.000	20.5	19.5	364.8
700 x 550	711.0 x 559.0	521	495	165.8
28 x 24	28.000 x 24.000	20.5	20	368.9
700 x 600	711.0 x 609.6	521	508	167.7
30 x 16	30.000 x 16.000	22	19	409
750 x 400	762.2 x 406.4	559	483	185.5
30 x 18	30.000 x 18.000	22	19.5	411
750 x 450	762.2 x 457.2	559	495	186.8
30 x 20	30.000 x 20.000	22	20	413.6
750 x 500	762.2 x 508.0	559	508	188
30 x 22	30.000 x 22.000	22	20.5	416.9
750 x 550	762.2 x 559.0	559	521	189.5
30 x 24	30.000 x 24.000	22	21	420.6
750 x 610	762.2 x 609.6	559	533	191.2
30 x 28	30.000 x 28.000	22	21.5	425.9
750 x 700	762.2 x 711.0	559	546	193.6
32 x 20	32.000 x 20.000	23.5	21	469.7
800 x 500	813.0 x 508.0	597	533	213.5
32 x 22	32.000 x 22.000	23.5	21.5	472.6
800 x 550	813.0 x 559.0	597	546	214.8
32 x 24	32.000 x 24.000	23.5	22	476
800 x 600	813.0 x 609.6	597	559	216.4
32 x 28	32.000 x 28.000	23.5	22.5	480.9
800 x 700	813.0 x 711.0	597	572	218.6
32 x 30	32.000 x 30.000	23.5	23	486.2
800 x 750	813.0 x 762.0	597	584	221
36 x 22	36.000 x 22.000	26.5	23.5	595.8
900 x 550	914.0 x 559.0	673	597	270.8
36 x 24	36.000 x 24.000	26.5	24	598.8
900 x 600	914.0 x 609.6	673	610	272.2
36 x 28	36.000 x 28.000	26.5	24.5	602.6
900 x 700	914.0 x 711.0	673	622	273.9
36 x 30	36.000 x 30.000	26.5	25	607.2
900 x 750	914.0 x 762.0	673	635	276
36 x 32	36.000 x 32.000	26.5	25.5	612.5
900 x 800	914.0 x 813.0	673	648	278.4
40 x 24	40.000 x 24.000	29.5	26	736.3
1000 x 600	1016.0 x 609.6	749	660	334.7
40 x 28	40.000 x 28.000	29.5	26.5	739.6
1000 x 700	1016.0 x 711.0	749	673	336.2
40 x 30	40.000 x 30.000	29.5	27.5	748.2
1000 x 750	1016.0 x 762.0	749	698	340.1
42 x 24	42.000 x 24.000	30	26	778.1
1050 x 600	1067.0 x 609.6	762	660	353.7
42 x 28	42.000 x 28.000	30	27.5	788
1050 x 700	1067.0 x 711.0	762	698	358.2
42 x 30	42.000 x 30.000	30	28	792
1050 x 750	1067.0 x 762.0	762	711	360
42 x 32	42.000 x 32.000	30	28	791.6
1050 x 800	1067.0 x 813.0	762	711	359.8
42 x 36	42.000 x 36.000	30	28	791.1
1050 x 900	1067.0 x 914.0	762	711	359.6
42 x 40	42.000 x 40.000	30	28	791.1
1050 x 1000	1067.0 x 1016.0	762	711	359.6

WROUGHT GROOVED FITTINGS

W150 Wrought concentric reducer
 W151 Wrought eccentric reducer

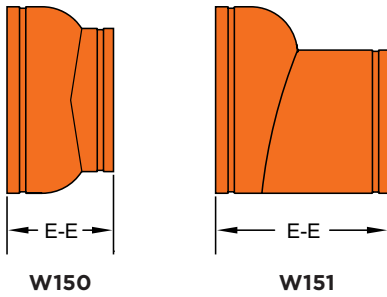

Material: Fabricated with ASTM A234 Gr. WPB, standard weight (0.375" or 9.5 mm), or segmentally welded carbon steel of the same or equivalent grade.

E-E dimensions: conform to ANSI B16.9.

DIMENSIONS

NOMINAL SIZE	PIPE O.D.	W150 CONCENTRIC REDUCER		W151 ECCENTRIC REDUCER	
		E - E	WEIGHT	E - E	WEIGHT
in	in	in	lb	in	lb
mm	mm	mm	kg	mm	kg
14 x 6	14.000 x 6.625	13.00	67.76	13.00	67.76
350 x 150	355.6 x 168.3	330	30.8	330	30.8
14 x 8	14.000 x 8.625	13	69.96	13	69.96
350 x 200	355.6 x 219.1	330	31.8	330	31.8
14 x 10	14.000 x 10.750	13	71.94	13	71.94
350 x 250	355.6 x 273.0	330	32.7	330	32.7
14 x 12	14.000 x 12.750	13	73.92	13	73.92
350 x 300	355.6 x 323.9	330	33.6	330	33.6
16 x 8	16.000 x 8.625	14	87.78	14	87.78
400 x 200	406.4 x 219.1	356	39.9	356	39.9
16 x 10	16.000 x 10.750	14	90.86	14	90.86
400 x 250	406.4 x 273.0	356	41.3	356	41.3
16 x 12	16.000 x 12.750	14	92.84	14	92.84
400 x 300	406.4 x 323.9	356	42.2	356	42.2
16 x 14	16.000 x 14.000	14	94.82	14	94.82
400 x 350	406.4 x 355.6	356	43.1	356	43.1
18 x 10	18.000 x 10.750	15	111.76	15	111.76
450 x 250	457.2 x 273.0	381	50.8	381	50.8
18 x 12	18.000 x 12.750	15	114.84	15	114.84
450 x 300	457.2 x 323.9	381	52.2	381	52.2
18 x 14	18.000 x 14.000	15	117.7	15	117.7
450 x 350	457.2 x 355.6	381	53.5	381	53.5
18 x 16	18.000 x 16.000	15	120.78	15	120.78
450 x 400	457.2 x 406.4	381	54.9	381	54.9
20 x 12	20.000 x 12.750	20	159.72	20	159.72
500 x 300	508.0 x 323.9	508	72.6	508	72.6
20 x 14	20.000 x 14.000	20	163.68	20	163.68
500 x 350	508.0 x 355.6	508	74.4	508	74.4
20 x 16	20.000 x 16.000	20	167.64	20	167.64
500 x 400	508.0 x 406.4	508	76.2	508	76.2
20 x 18	20.000 x 18.000	20	171.6	20	171.6
500 x 450	508.0 x 457.2	508	78	508	78
24 x 16	24.000 x 16.000	20	197.56	20	197.56
600 x 400	609.6 x 406.4	508	89.8	508	89.8
24 x 18	24.000 x 18.000	20	199.54	20	199.54
600 x 450	609.6 x 457.2	508	90.7	508	90.7
24 x 20	24.000 x 20.000	20	203.5	20	203.5
600 x 500	609.6 x 508.0	508	92.5	508	92.5
28 x 18	28.000 x 18.000	24	191.8	24	191.8
700 x 450	711.2 x 457.2	610	87	610	87

W135 Cross
W137 True-Y

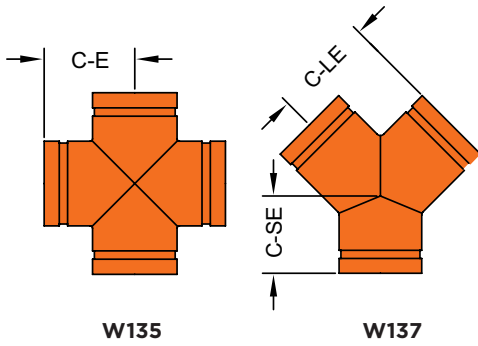

Material: Fabricated with ASTM A234 Gr. WPB, standard weight (0.375" or 9.5 mm), or segmentally welded carbon steel of the same or equivalent grade.

C-LE and C-SE dimensions: manufacturer's standard.

DIMENSIONS

NOMINAL SIZE	PIPE O.D.	W130 45° LATERAL		
		C-LE	C-SE	WEIGHT
in	in	in	in	lb
mm	mm	mm	mm	kg
14	14.000	26.5	7.5	219.14
350	355.6	673	191	99.4
16	16.000	29.0	8.0	270.5
400	406.4	737	203	122.7
18	18.000	32.0	8.5	332.7
450	457.2	813	216	150.9
20	20.000	35.0	9.0	401.3
500	508.0	889	229	182.0
24	24.000	40.0	10.0	541.3
600	609.6	1016	254	245.5
28	28.0	44.0	11.0	934.0
700	711.0	1118	279	423.7
30	30.0	46.0	11.5	1048.0
750	762.0	1169	292	475.2
32	32.0	48.0	12.0	1167.0
800	813.0	1219	305	529.5
36	36.0	52.0	13.0	1423.6
900	914.0	1321	330	645.7
40	40.0	56.0	14.0	1706.0
1000	1016.0	1422	356	773.8
42	42.0	58.0	14.5	1857.0
1050	1067.0	1473	368	842.1

WROUGHT LONG RADIUS ELBOWS (BENDS)

L90-3D	90°	L45-3D	45°	L22-3D	22-1/2°
L60-3D	60°	L30-3D	30°	L11-3D	11-1/4°



- Long radius 90° elbows 3D, 5D, and 6D in sizes up to and including 4" are provided with 4" (102 mm) long tangents, sizes 5" to 10" are provided with 1D long tangents and sizes 12" to 24" are provided with 12" (305 mm) long tangents.
- End Preparation: Roll-grooved to AWWA C606-04 and or ISO/FDIS 6182-12. For dimensional tolerances of cast fittings, refer to ISO/FDIS 6182-12 Table Plain-end, beveled end or cut-grooved ends are also available upon request.
- Material: Standard wall steel pipe to ASTM A53, Grade B. Other materials also available on request.
- C to E tolerances: 2" through 6" ± " (3.2 mm); 8" through 16" ±1/4" (6.4 mm); 18" through 24" ± " (9.5 mm).
- All weights are approximate, based on calculated weight of pipe.

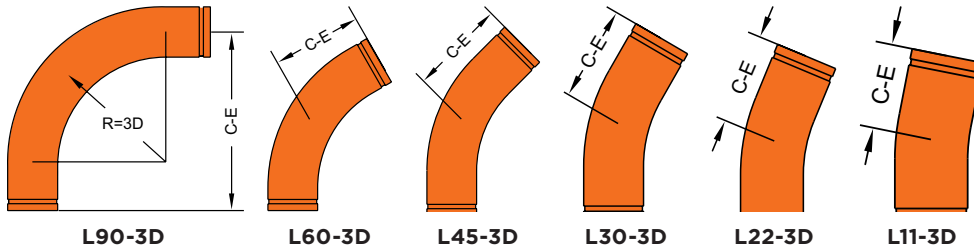

DIMENSIONS

NOMINAL SIZE	PIPE O.D.	L90-3D 90° ELBOW		L60-3D 60° ELBOW		L45-3D 45° ELBOW		L30-3D 30° ELBOW		L22-3D 22-1/2° ELBOW		L11-3D 11-1/4° ELBOW	
		C - E	WEIGHT	C - E	WEIGHT	C - E	WEIGHT	C - E	WEIGHT	C - E	WEIGHT	C - E	WEIGHT
in	in	in	lb	in	lb	in	lb	in	lb	in	lb	in	lb
mm	mm	mm	kg	mm	kg	mm	kg	mm	kg	mm	kg	mm	kg
2	2.375	10.0	5.5	7.50	4.3	6.50	3.7	5.75	3.4	5.25	3.2	4.50	2.8
50	60.3	254	2.5	191	2.0	165	1.7	146	1.5	133	1.5	114	1.3
2-1/2	2.875	11.5	9.9	8.25	7.7	7.25	6.7	6.00	5.8	5.50	5.3	4.75	4.6
65	73.0	292	4.5	210	3.5	184	3.0	152	2.6	140	2.4	121	2.1
3	3.500	13.0	14.6	9.25	11.0	7.75	10.1	6.50	8.0	5.75	7.3	5.00	6.2
80	88.9	330	6.6	235	5.0	197	4.6	165	3.6	146	3.3	127	2.8
3-1/2	4.000	14.5	18.6	10.00	14.4	8.50	12.0	6.75	10.2	6.00	9.2	5.00	7.6
90	101.6	368	8.4	254	6.5	216	5.6	171	4.6	152	4.2	127	3.4
4	4.500	16.0	22.4	11.00	18.5	9.00	14.7	7.25	12.8	6.50	11.4	5.25	9.3
100	114.3	406	10.2	279	8.4	229	7.0	184	5.8	165	5.2	133	4.2
5	5.563	20.0	40.5	13.75	31.3	11.25	26.9	9.00	21.8	8.00	19.4	6.50	15.8
125	141.3	508	18.4	349	14.2	286	12.2	229	9.9	203	8.8	165	7.2
6	6.625	24.0	60.7	16.50	48.8	13.50	39.7	10.75	33.9	9.50	30.1	7.75	24.6
150	168.3	610	27.5	419	22.1	343	18.0	273	15.4	241	13.7	197	11.2
8	8.625	32.0	132.3	22.00	97.9	18.00	86.0	14.50	68.0	12.75	60.5	10.50	49.3
200	219.1	813	60.0	559	44.4	457	39.0	368	30.8	324	27.4	267	22.4
10	10.750	40.0	211.6	27.25	173.4	22.50	136.7	18.00	120.5	16.00	107.2	13.00	87.3
250	273.0	1016	96.0	692	78.7	572	62.0	457	54.7	406	48.6	330	39.6
12	12.750	48.0	319.7	32.75	254.8	27.00	205.0	21.75	177.0	19.25	157.5	15.50	128.3
300	323.9	1219	145.0	832	115.6	686	93.0	552	80.3	489	71.4	394	58.2
14	14.000	54.0	390.2	38.25	327.3	31.50	227.3	25.25	227.3	22.50	202.3	18.25	164.8
350	355.6	1372	177.0	972	148.5	800	103.1	641	103.1	572	91.8	464	74.8
16	16.000	60.0	546.8	43.75	429.0	36.00	350.5	29.00	297.9	25.25	265.2	20.75	216.0
400	406.4	1524	248.0	1111	194.6	914	159.0	737	135.1	648	120.3	527	98
18	18.000	66.0	639.2	49.25	544.4	40.25	461.3	32.50	378.1	28.75	336.5	23.35	274.1
450	457.2	1676	290.6	1251	246.9	1029	209.2	826	171.5	730	152.6	593	124.3
20	20.000	72.0	778.6	54.75	673.5	45.00	568.8	36.00	467.8	32.00	416.3	26.00	339.2
500	508.0	1829	353.15	1391	305.5	1143	258.0	914	212.2	813	188.8	660	153.9
24	24.000	84.0	1442.5	65.50	1297.5	53.75	1099.6	43.25	903.5	38.25	804.5	31.00	655.1
600	609.6	2134	654.3	1664	588.5	1365	498.8	1099	409.8	972	364.9	787	297.2
28	28.000	95.0	1897.5	70.00	1714.5	62.00	1486.6	47.00	1150.7	45.00	1109.3	35.00	868.6
700	711.2	2413	860.7	1778	777.7	1575	674.3	1194	522.0	1143	503.2	889	394.0
30	30	102	~2200.0										
750	762	2591	~997.9										

* For 24" - 30": Made by XS (12.7mm) carbon steel pipe to ASTM A53.

WROUGHT LONG RADIUS ELBOWS (BENDS)

L90-5D 90° | L45-5D 45° | L22-5D 22-1/2°
 L60-5D 60° | L30-5D 30° | L11-5D 11-1/4°

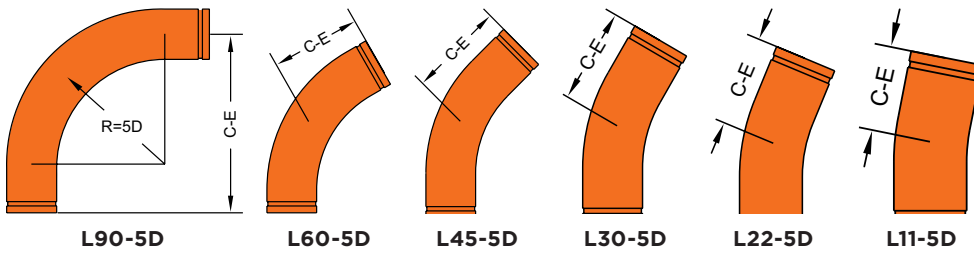

DIMENSIONS

NOMINAL SIZE	PIPE O.D.	L90-5D 90° ELBOW		L60-5D 60° ELBOW		L45-5D 45° ELBOW		L30-5D 30° ELBOW		L22-5D 22-1/2° ELBOW		L11-5D 11-1/4° ELBOW	
		C - E	WEIGHT	C - E	WEIGHT	C - E	WEIGHT	C - E	WEIGHT	C - E	WEIGHT	C - E	WEIGHT
in	in	in	Lbs	in	lb	in	lb	in	lb	in	lb	in	lb
mm	mm	mm	Kgs	mm	kg	mm	kg	mm	kg	mm	kg	mm	kg
2	2.375	14.00	7.2	9.75	5.6	8.25	4.8	6.75	4.0	6.00	3.6	5.00	3.0
50	60.3	356	3.3	248	2.5	210	2.2	171	1.8	152	1.6	127	1.4
2-1/2	2.875	16.50	13.3	11.25	10.2	9.25	8.6	7.50	7.0	6.50	6.2	5.25	5.0
65	73.0	419	6.1	286	4.6	235	3.9	191	3.2	165	2.8	133	2.3
3	3.500	19.00	19.9	12.75	15.0	10.25	12.5	8.00	10.0	7.00	8.8	5.50	6.9
80	88.9	483	9.0	324	6.8	260	5.7	203	4.5	178	4.0	140	3.1
3-1/2	4.000	21.50	26.9	12.25	20.0	11.25	16.5	8.75	13.0	7.50	11.3	5.75	8.7
90	101.6	546	12.2	311	9.1	286	7.5	222	5.9	191	5.1	146	3.9
4	4.500	24.00	35.4	15.50	26.0	12.50	21.3	9.50	16.6	8.00	14.3	6.00	10.7
100	114.3	610	16.1	394	11.8	318	9.7	241	7.5	203	6.5	152	4.9
5	5.563	30.00	59.9	19.50	44.1	15.50	36.1	11.75	28.1	10.00	24.1	7.50	18.2
125	141.3	762	27.2	495	20.0	394	16.4	298	12.7	254	10.9	191	8.3
6	6.625	36.00	93.3	23.25	68.6	18.50	56.2	14.00	43.8	12.00	37.6	9.00	28.3
150	168.3	914	42.4	591	31.1	470	25.5	356	19.9	305	17.1	229	12.8
8	8.625	48.00	187.4	31.00	137.7	24.50	112.8	18.75	87.9	16.00	75.4	12.00	56.8
200	219.1	1219	85.2	787	62.5	622	51.2	476	39.9	406	34.2	305	25.8
10	10.750	60.00	332.0	39.00	244.1	30.75	199.9	23.50	155.8	20.00	133.7	15.00	100.6
250	273.1	1524	150.9	991	110.7	781	90.7	597	70.7	508	60.6	381	45.6
12	12.750	72.00	488.0	46.75	358.6	37.00	293.7	28.00	228.9	24.00	196.4	18.00	147.8
300	323.9	1829	221.8	1187	162.7	940	133.2	711	103.8	610	89.1	457	67.0
14	14.000	82.00	608.5	54.50	460.7	43.00	377.3	32.75	294.0	28.00	252.3	21.00	189.8
350	355.6	2083	276.6	1384	209	1092	171.1	832	133.4	711	114.4	533	86.1
16	16.000	92.00	779.7	62.25	603.8	49.25	494.5	37.50	385.3	32.00	330.7	24.00	248.8
400	406.4	2337	354.4	1581	273.9	1251	224.3	953	174.8	813	150	610	112.9
18	18.000	102.00	971.4	70.00	766.2	55.25	627.6	42.25	489.0	36.00	419.7	27.00	315.7
450	457.2	2591	441.5	1778	347.5	1403	284.7	1073	221.8	914	190.4	686	143.2
20	20.000	112.00	1184.9	77.75	947.9	61.50	776.4	46.75	605.0	40.00	519.2	30.00	390.6
500	508.0	2845	538.6	1975	430.0	1562	352.2	1187	274.4	1016	235.5	762	177.2
24	24.000	132.00	1674.9	93.25	1369.3	73.75	1121.6	56.25	873.9	48.00	750.1	35.75	564.3
600	609.6	3353	761.3	2369	621.1	1873	508.7	1429	396.4	1219	340.2	908	256.0

WROUGHT LONG RADIUS ELBOWS (BENDS)



L90-6D 90° | L45-6D 45° | L22-6D 22-1/2°
 L60-6D 60° | L30-6D 30° | L11-6D 11-1/4°

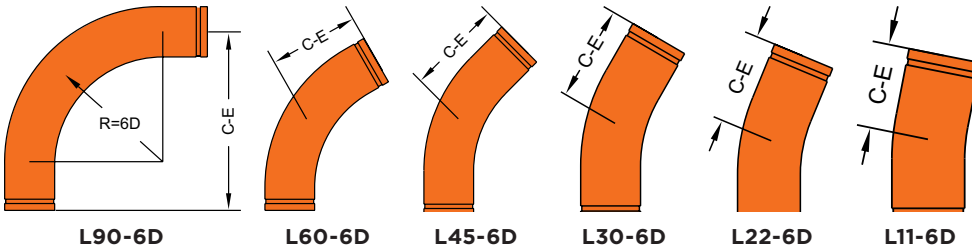

DIMENSIONS

NOMINAL SIZE	PIPE O.D.	L90-6D 90° ELBOW		L60-6D 60° ELBOW		L45-6D 45° ELBOW		L30-6D 30° ELBOW		L22-6D 22-1/2° ELBOW		L11-6D 11-1/4° ELBOW	
		C - E	WEIGHT	C - E	WEIGHT	C - E	WEIGHT	C - E	WEIGHT	C - E	WEIGHT	C - E	WEIGHT
2	2.375	16.00	8.2	11.00	6.3	9.00	5.3	7.25	4.3	6.50	3.9	5.25	3.2
50	60.3	406	3.7	279	2.9	229	2.4	184	2.0	165	1.8	133	1.5
2-1/2	2.875	19.00	15.2	12.75	11.4	10.25	9.5	8.00	7.7	7.00	6.7	5.50	5.3
65	73.0	483	6.9	324	5.2	260	4.3	203	3.5	178	3.0	140	2.4
3	3.500	22.00	22.9	14.50	17.0	11.50	14	8.75	11.0	7.50	9.5	5.75	7.3
80	88.9	559	10.4	368	7.7	292	6.4	222	5.0	191	4.3	146	3.3
3-1/2	4.000	25.00	31.1	16.25	22.8	12.75	18.6	9.75	14.4	8.25	12.3	6.00	9.2
90	101.6	635	14.1	413	10.3	324	8.4	248	6.5	210	5.6	152	4.2
4	4.500	28.00	41.0	18.00	29.8	14.00	24.1	10.50	18.5	8.75	15.7	6.50	11.4
100	114.3	711	18.6	457	13.5	356	10.9	267	8.4	222	7.1	165	5.2
5	5.563	35.00	69.5	22.25	50.5	17.50	40.9	13.00	31.3	11.00	26.5	8.00	19.4
125	141.3	889	31.6	565	22.9	445	18.6	330	14.2	279	12.0	203	8.8
6	6.625	42.00	108.2	26.75	78.6	21.00	63.7	15.75	48.8	13.25	41.3	9.50	30.1
150	168.3	1067	49.2	679	35.7	533	28.9	400	22.1	337	18.7	241	13.7
8	8.625	56.00	217.2	35.75	157.7	28.00	127.8	21.00	97.9	17.50	82.9	12.75	60.5
200	219.1	1422	98.7	908	71.5	711	58.0	533	44.4	445	37.6	324	27.4
10	10.750	70.00	384.9	44.75	279.4	35.00	226.4	26.00	173.4	22.00	146.9	16.00	107.2
250	273.1	1778	174.9	1137	126.7	889	102.7	660	78.7	559	66.6	406	48.6
12	12.750	84.00	565.8	53.50	410.5	41.75	332.7	31.25	254.8	26.25	215.9	19.00	157.5
300	323.9	2134	257.2	1359	186.2	1060	150.9	794	115.6	667	97.9	483	71.4
14	14.000	96.00	708.4	62.50	527.3	48.75	427.3	36.50	327.3	30.75	277.3	22.25	202.3
350	355.6	2438	322.0	1588	239.2	1238	193.8	927	148.5	781	125.8	565	91.8
16	16.000	108.00	910.6	71.50	691.1	55.75	560.1	41.75	429.0	35.25	363.5	25.50	265.2
400	406.4	2743	413.9	1816	313.5	1416	254.1	1060	194.6	895	164.9	648	120.3
18	18.000	120.00	1137.4	80.50	877.1	62.75	710.7	47.00	544.4	39.50	461.3	28.75	336.5
450	457.2	3048	517.0	2045	397.8	1594	322.4	1194	246.9	1003	209.2	730	152.6
20	20.000	132.00	1390.4	89.25	1085.1	69.75	879.3	52.25	673.5	44.00	570.7	31.75	416.3
500	508.0	3353	632.0	2267	492.2	1772	398.8	1327	305.5	1118	258.9	806	188.8
24	24.000	156.00	1972.1	107.25	1567.5	83.75	1270.3	62.50	973.0	52.34	824.4	38.25	601.4
600	609.6	3962	896.4	2724	711	2127	576.2	1588	441.3	1329	373.9	972	272.8

- 901 90° Elbow, short radius
- 903 Tee, short radius

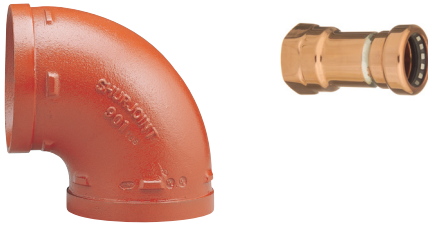

Shurjoint short radius fittings are primarily designed for fire applications. The Z05 rigid couplings can be used with short radius fittings without the worry of bolt pad interference.

Shurjoint grooved-end fittings are made of ductile iron per ASTM A536 Gr. 65-45-12 and or ASTM A395 Gr. 65-45-15. C-E dimensions are manufacturer's standard.

For Fire Protection pressure rating, listing, and approval information, refer to Data Sheet B-42 or visit www.shurjoint.com for details or contact Shurjoint.

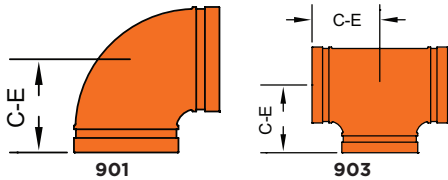

DIMENSIONS

NOMINAL SIZE	PIPE O.D.	901 90° ELBOW		903 TEE	
		C-E	WEIGHT	C-E	WEIGHT
in	in	in	lb	in	lb
mm	mm	mm	kg	mm	kg
2	2.375	2.75	1.5	2.75	2.2
50	60.3	70	0.7	70	1.0
2-1/2	2.875	3.00	2.0	3	2.9
65	73.0	76	0.9	76	1.3
3	3.500	3.38	3.1	3.38	4.4
80	88.9	86	1.4	86	2.0
4	4.500	4.00	4.9	4	7.9
100	114.3	102	2.2	102	3.5
5	5.563	4.88	7.9	4.88	10.1
125	141.3	124	3.6	124	4.6
6	6.625	5.50	12.9	5.5	17.2
150	168.3	140	5.9	140	7.8
8	8.625	6.94	23.4	6.94	36.3
200	219.1	176	10.6	176	16.5

MATERIAL SPECIFICATIONS

FITTING BODY:

- Ductile Iron castings to ASTM A536, Gr. 65-45-12 and or to ASTM A395, Gr. 65-45-15, min. tensile strength 65,000 psi (448 MPa).

SURFACE FINISH:

- Standard orange paint finish.
- Hot dip galvanized (optional)
- Epoxy coatings in RAL3000 red or other colors (optional)

GENERAL NOTES

- Maximum Working Pressure (CWP) listed is the maximum cold water pressure for general piping services tested to ASTM F1476 and or AWWA C606 methods. Figures listed are based on roll- or cut-grooved standard wall carbon steel pipe. For other pipe schedules or pipe materials, contact Shurjoint for additional information.
- Max. End Load is calculated based on the maximum working pressure (CWP).
- Listed and or Approved Pressures are pressure ratings for fire protection systems, tested and approved by various approval bodies. Please always refer to the latest approval data posted on the Shurjoint website.
- Field Joint Test: For one time only the system may be tested hydrostatically at 1.5 times the maximum working pressure listed (AWWA C606 5.2.3).
- Warning: Piping systems must always be depressurized and drained before attempting disassembly and or removal of any components.
- The 10 Year Limited Warranty applies to manufacturing defects only and does not cover severe service/temperature applications or wear parts.
- Shurjoint reserves the right to change specifications, designs and or standard without notice and without incurring any obligations.

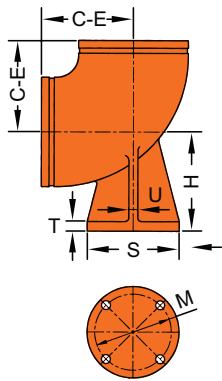

Model 7110-B is a ductile iron 90° grooved-end elbow with base support, designed for installation at the bottom of a riser system. An anchor can be placed in conjunction with the base support to support the weight of the pipe, coupling and fluid.

DIMENSIONS

NOMINAL SIZE	PIPE O.D.	DIMENSIONS						WEIGHT
		C - E	H	U	T	S	M	
in	in	in	in	in	in	in	in	lb
mm	mm	mm	mm	mm	mm	mm	mm	kg
3	3.500	4.25	4.88	0.50	0.56	5.00	3.88	10.5
80	88.9	108	124	13	14	127	99	4.8
4	4.500	5.00	5.50	0.50	0.62	6.00	4.75	15.2
100	114.3	127	140	13	16	152	121	6.9
6	6.625	6.50	7.00	0.62	0.69	7.00	5.50	26.3
150	168.3	165	178	16	18	178	140	11.9
8	8.625	7.76	8.38	0.88	0.94	9.00	7.50	56.9
200	219.1	197	213	22	24	229	191	25.8
10	10.750	9.02	9.75	0.88	0.94	9.00	7.50	88.9
250	273.0	229	248	22	24	229	191	40.3
12*	12.750	10.00	11.25	1.00	1.00	11.00	9.50	70.4
300	323.9	254	286	25	25	279	241	32.0

*Non-standard/stock items may require longer lead time.

7110DR DRAIN ELBOW

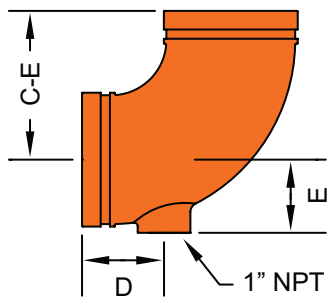

The Model 7110DR is a grooved-end ductile iron cast elbow with an integral 1" NPT drain. The 7110DR was primarily designed for, but not limited to, use on fire protection standpipes.

DIMENSIONS

NOMINAL SIZE	PIPE O.D.	DIMENSIONS			WEIGHT
		C - E	D	E	
in	in	in	in	in	lb
mm	mm	mm	mm	mm	kg
2	2.375	3.27	2.25	1.57	2.2
50	60.3	83	57	40	1.0
2-1/2	2.875	3.75	2.75	1.57	2.8
65	73.0	95	70	40	1.3
3	3.500	4.25	2.75	1.93	4.6
80	88.9	108	70	49	2.1
4	4.500	5.00	2.75	2.48	6.6
100	114.3	127	70	63	3.0
6	6.625	6.50	2.75	3.54	13.4
150	168.3	165	70	90	6.1
8	8.625	7.76	3.27	4.49	25.6
200	219.1	197	83	114	11.6

*Non-standard/stock items may require longer lead time.



Shurjoint ductile iron grooved-end fittings are made of ductile iron per ASTM A536 Gr. 65-45-12 and or ASTM A395 Gr. 65-45-15. C-E dimensions are manufacturer's standard.

The Shurjoint Models 7150F & 7150M are designed for making direct reduction from a grooved system to female or male threaded system without the need for expensive swaged nipples.

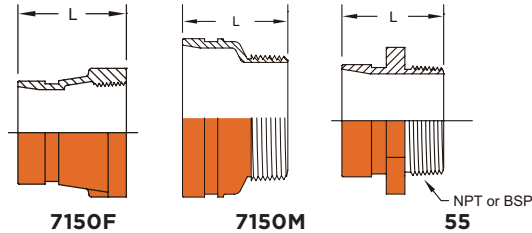

DIMENSIONS

7150F | 7150M

NOMINAL SIZE GR. X TH.	PIPE O.D.	7150F		7150M	
		L	WEIGHT	L	WEIGHT
in	in	in	lb	in	lb
mm	mm	mm	kg	mm	kg
1-1/2 x 1	1.900 x 1.315	2.5	0.60	2.5	0.53
40 x 25	48.3 x 33.4	63.5	0.27	63.5	0.24
2 x 1	2.375 x 1.315	2.5	0.92	2.5	0.88
50 x 25	60.3 x 33.4	63.5	0.42	63.5	0.40
2 x 1-1/4	2.375 x 1.660	2.5	1.01	2.5	0.70
50 x 32	60.3 x 42.2	63.5	0.46	63.5	0.32
2 x 1-1/2	2.375 x 1.900	2.5	0.95	2.5	1.04
50 x 40	60.3 x 48.3	63.5	0.43	63.5	0.47
2-1/2 x 1	2.875 x 1.315	2.5	1.21	2.5	0.88
65 x 25	73.0 x 33.4	63.5	0.55	63.5	0.40
2-1/2 x 1-1/4	2.875 x 1.660	2.5	1.17	2.5	1.59
65 x 32	73.0 x 42.2	63.5	0.53	63.5	0.72
2-1/2 x 1-1/2	2.875 x 1.900	2.5	1.08	2.5	1.72
65 x 40	73.0 x 48.3	63.5	0.49	63.5	0.78
2-1/2 x 2	2.875 x 2.375	2.5	1.52	2.5	0.92
65 x 50	73.0 x 60.3	63.5	0.69	63.5	0.42
3 x 1	3.500 x 1.315	2.5	1.91	2.5	1.25
80 x 25	88.9 x 33.4	63.5	0.87	63.5	0.57
3 x 1-1/4	3.500 x 1.660	2.5	1.50	2.5	1.67
80 x 32	88.9 x 42.2	63.5	0.68	63.5	0.76
3 x 1-1/2	3.500 x 1.900	2.5	1.63	2.5	1.53
80 x 40	88.9 x 48.3	63.5	0.74	63.5	0.74
3 x 2	3.500 x 2.375	2.5	1.56	2.5	1.32
80 x 50	88.9 x 60.3	63.5	0.71	63.5	0.60
3 x 2-1/2	3.500 x 2.875	2.5	2.20	2.5	2.20
80 x 65	88.9 x 73.0	63.5	1.00	63.5	1.00
4 x 1-1/4	4.500 x 1.660	3	2.33	3	2.19
100 x 32	114.3 x 42.2	76.1	1.06	76.1	0.99
4 x 1-1/2	4.500 x 1.900	3	2.05	3	2.05
100 x 40	114.3 x 48.3	76.1	0.93	76.1	0.93
4 x 2	4.500 x 2.375	3	2.29	3	2.31
100 x 50	114.3 x 60.3	76.1	1.03	76.1	1.05
4 x 2-1/2	4.500 x 2.875	3	2.25	3	2.05
100 x 65	114.3 x 73.0	76.1	1.02	76.1	0.93

NOMINAL SIZE GR. X TH.	PIPE O.D.	7150F		7150M	
		L	WEIGHT	L	WEIGHT
in	in	in	lb	in	lb
mm	mm	mm	kg	mm	kg
5 x 1-1/2	5.563 x 1.900	3.5*	3.94	3.5*	2.05
125 x 40	141.3 x 48.3	88.9	1.79	88.9	0.93
6 x 1-1/2	6.625 x 1.900	4	6.47	4	4.84
150 x 40	168.3 x 48.3	101.6	2.94	101.6	2.20
6 x 2	6.625 x 2.375	4	5.28	4	4.91
150 x 50	168.3 x 60.3	101.6	2.40	101.6	2.23
6 x 2-1/2	6.625 x 2.875	4	5.46	4	4.91
150 x 65	168.3 x 73.0	101.6	2.48	101.6	2.23
6 x 4	6.625 x 4.500	4	6.37	4	4.52
150 x 100	168.3 x 114.3	101.6	2.89	101.6	2.10

*Non-standard/stock items may require longer lead time.

DIMENSIONS

55

NOMINAL SIZE GR. X MPT	PIPE O.D.	55	
		L	WEIGHT
in	in	in	lb
mm	mm	mm	kg
1-1/2 x 1-1/2M	1.900	2.50	0.77
40 x 40M	48.3	63.5	0.35
2 x 2M	2.375	2.50	0.90
50 x 50M	60.3	63.5	0.40

GROOVED-END FITTINGS

56 Hose nipple | 58 Nipple (gr x bev)
 57 Nipple (gr x gr) | 59 Nipple (gr x mt)



The Shurjoint Model 56 hose nipple allows for a direct connection with rubber or plastic hoses.

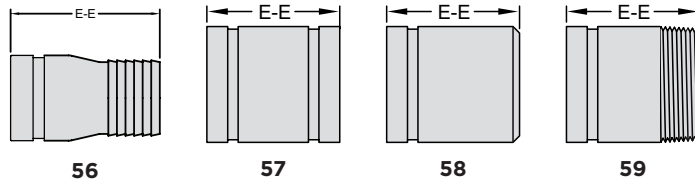

DIMENSIONS

NOMINAL SIZE	PIPE O.D.	56 (HOSE NIPPLE)		57 (GR X GR)		58 (GR X BEV)		59 (GR X TH)	
		E - E	WEIGHT	E - E	WEIGHT	E - E	WEIGHT	E - E	WEIGHT
in	in	in	lb	in	lb	in	lb	in	lb
mm	mm	mm	kg	mm	kg	mm	kg	mm	kg
3/4	1.050	---	---	3	0.29	3	0.29	3	0.29
20	26.7	---	---	76	0.13	76	0.13	76	0.13
1	1.315	3.3	0.4	3	0.42	3	0.42	3	0.42
25	33.4	83	0.2	76	0.19	76	0.19	76	0.19
1-1/4	1.660	3.6	0.7	4	0.68	4	0.70	4	0.66
32	42.2	92	0.3	102	0.31	102	0.32	102	0.30
1-1/2	1.900	4.0	0.7	4	0.82	4	0.84	4	0.79
40	48.3	102	0.3	102	0.37	102	0.38	102	0.36
2	2.375	4.6	1.2	4	1.10	4	1.10	4	1.10
50	60.3	117	0.6	102	0.50	102	0.50	102	0.50
2-1/2	2.875	5.5	2.2	4	1.76	4	1.76	4	1.54
65	73.0	140	1.0	102	0.80	102	0.80	102	0.72
3	3.500	6.0	3.3	4	2.40	4	2.40	4	2.20
80	88.9	152	1.5	102	1.10	102	1.10	102	1.00
4	4.500	7.25	5.5	6	5.17	6	5.17	6	4.84
100	114.3	184	2.5	152	2.35	152	2.35	152	2.20
5	5.563	9.75	8.1	6	7.26	6	7.26	6	6.60
125	141.3	248	3.7	152	3.30	152	3.30	152	3.00
6	6.625	11.0	14.5	6	9.90	6	9.90	6	9.81
150	168.3	279	6.6	152	4.50	152	4.50	152	4.46
8	8.625	12.5	24.2	6	14.30	6	14.30	---	---
200	219.1	318	11.0	152	6.50	152	6.50	---	---
10	10.750	14.0	29.0	8	27.06	8	19.00	---	---
250	273.0	356	13.2	203	12.30	203	8.66	---	---
12	12.750	16.0	46.0	8	35.64	8	22.35	---	---
300	323.9	406	20.9	203	16.20	203	10.16	---	---
14	14.000	---	---	8	36.38	8	36.38	---	---
350	355.6	---	---	203	16.50	203	16.50	---	---
16	16.000	---	---	8	41.67	8	41.67	---	---
400	406.4	---	---	203	18.90	203	18.90	---	---
18	18.000	---	---	8	47.19	8	47.19	---	---
450	457.0	---	---	203	21.40	203	21.40	---	---
20	20.000	---	---	8	52.48	8	52.48	---	---
500	508.0	---	---	203	23.80	203	23.80	---	---
24	24.000	---	---	8	63.28	8	63.28	---	---
600	610.0	---	---	203	28.70	203	28.70	---	---

EXTRA HEAVY FITTINGS

10EP	90° Elbow	22EP	Header tee
11EP	45° Elbow		
20EP	Tee		
35EP	Cross		

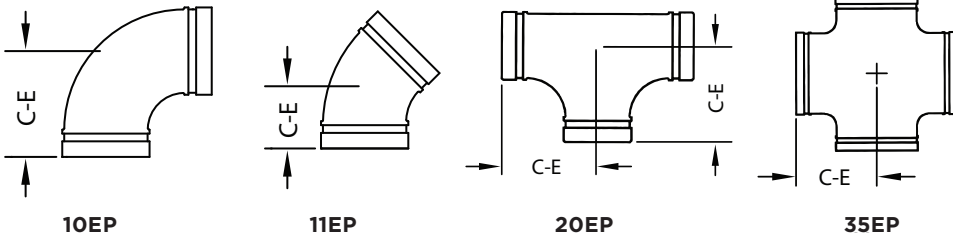

DIMENSIONS

NOMINAL SIZE	PIPE O. D.	10EP 90° ELBOW		11EP 45° ELBOW		20EP TEE		35EP CROSS	
		C - E	WEIGHT	C - E	WEIGHT	C - E	WEIGHT	C - E	WEIGHT
in	in	in	lb	in	lb	in	lb	in	lb
mm	mm	mm	kg	mm	kg	mm	kg	mm	kg
2	2.375	3.25	2.5	2.00	1.8	3.25	4.2	3.25	3.9
50	60.3	83	1.1	51	0.8	83	1.9	83	1.8
2-1/2	2.875	3.75	5.0	2.25	2.9	3.75	7.9	3.75	6.6
65	73.0	95	2.3	57	1.3	95	3.6	95	3.0
3	3.500	4.25	6.0	2.50	4.3	4.25	16.0	4.25	14.2
80	88.9	108	2.7	64	1.9	108	7.3	108	6.4
4	4.500	5.00	10.3	3.00	8.5	5.00	23.5	5.00	15.8
100	114.3	127	4.7	76	3.9	127	10.7	127	7.2
6	6.625	6.50	27.2	3.50	16.5	6.50	27.0	6.50	46.0
150	168.3	165	12.3	89	7.5	165	12.2	165	20.9

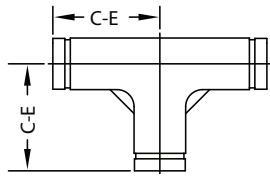

11EP

DIMENSIONS

NOMINAL SIZE	PIPE O. D.	22EP HEADER TEE	
		C - E	WEIGHT
in	in	in	lb
mm	mm	mm	kg
2 to 3	2.375	4.25	3.4
50 to 80	60.3	108	1.5
2 to 4	2.875	5	4.1
50 to 100	73	127	1.9





**stainless steel
series**

Shurjoint offers a full range of stainless steel grooved mechanical couplings in CF8 (304) and CF8M (316) for general service applications and in specialty alloys for applications including reverse osmosis and desalination systems. Grooved fittings are available in sizes from 1" (25 mm) to 24" (600 mm) produced in a combination of investment castings and wrought stainless.

The design pressure rating of Shurjoint stainless steel grooved couplings follows Class 150 and is based on roll grooved Sch. 10S pipe. Pressure ratings will vary depending on the type of pipe used and grooves processed. See page 101 Performance Data Sheet for pressure ratings (CWP) when used with other pipe schedules and cut-grooved pipe.

Shurjoint ductile iron couplings can be used in conjunction with stainless steel pipe, depending on the application, as the flow media does not come in direct contact with coupling housings but rather only the gasket. (See page 390 for performance data.)

Due to the different mechanical properties of stainless steel, it is more difficult to achieve a proper groove profile on thin wall stainless pipe, than carbon steel pipe. To achieve the stated pressure performance of a system, the groove should have a well-defined vertical wall and corner/shoulder which is necessary for the coupling to maintain a solid grip within the pipe groove. To better achieve the proper groove profile on thin wall stainless pipe, some manufacturers of pipe grooving machines/tools have designed the profiles of specific roller sets to achieve the well-defined vertical wall and corner/shoulder needed. For this reason, we recommend the use of those roller sets specifically designed for light wall stainless steel pipe, which create the groove profile necessary to achieve the stated pressures of the couplings. Failure to use roll sets specifically designed for light wall stainless steel pipe may result in significant loss of performance and possibly lead to damage of property, or personal injury.

If the same roll-set that has been used for carbon steel pipe is used on stainless steel pipe, rust or scale may be transferred to the stainless steel pipe during processing of the groove. Thus we recommend the use of a separate roll set specifically for use with stainless steel pipe. Also use caution to keep roll grooved stainless steel pipe dry prior to installation.

Groove corners are not defined

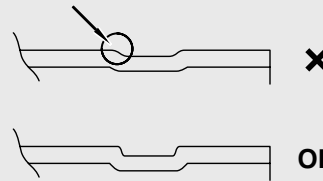

STAINLESS STEEL CASTING SPECIFICATIONS

GRADE (UNS)	AUSTENITIC STAINLESS STEEL			DUPLEX (AUSTENITIC / FERRITIC) STAINLESS STEEL		
	CF8 J92600	CF8M J92900	CK3MCUN J93254	2A, CE8MN J93345	4A, CD3MN J92205	5A, CE3MN J93404
COMPOSITION, % (MAX, EXCEPT WHERE RANGE IS GIVEN)						
Carbon	0.08	0.08	0.025	0.08	0.03	0.03
Manganese	1.50	1.50	1.20	1.00	1.50	1.50
Silicon	2.00	1.50	1.00	1.50	1.00	1.00
Sulfur	0.040	0.040	0.010	0.040	0.020	0.040
Phosphorus	0.040	0.040	0.045	0.040	0.040	0.040
Chromium	18.0-21.0	18.0-21.0	19.5-20.5	22.5-25.5	21.0-23.5	24.0-26.0
Nickel	8.0-11.0	9.0-12.0	17.5-19.5	8.0-11.0	4.5-6.5	6.0-8.0
Molybdenum	0.50	2.0-3.0	6.0-7.0	3.0-4.5	2.5-3.5	4.0-5.0
Nitrogen			0.18-0.24	0.10-0.30	0.10-0.30	0.10-0.30
Copper			0.50-1.00		1.00	
Tensile Requirements, min.						
Tensile Strength, ksi (MPa)	70 (485)	70 (485)	80 (550)	95 (655)	90 (620)	100 (690)
Yield Strength, ksi (MPa)	30 (205)	30 (205)	38 (260)	65 (450)	60 (415)	75 (515)
Elongation, %	35	30	35	25	25	18
ASTM Standards	A351/ A743/A744	A351/A743/A744	A351/A743/A744	A890/A351	A890	A890
Wrought Equivalent Grade	304	316	254SMO*	45D*	2205	SAF 2507*

* 254SMO is a registered trademark of AvestaPolarit AB, 45D is a registered trademark of ESCO Corporation and SAF 2507 is a registered trademark of AB Sandvik Steel.

Carbon Steel Roll Sets may cause rounding of the groove profile on Schedule 10 and light wall Stainless Steel Pipe. Thus we recommend the use of a separate roll set specifically for use with Stainless Steel Pipe.



The Model SS-7 Stainless Steel Rigid Coupling is the ideal coupling for use with Sch. 5S, Sch. 10S or Sch. 40S stainless steel pipe where a rigid connection is desired. The Model SS-7 features a tongue and groove mechanism and a heavy duty bolt pad design resulting in a positive rigid connection. The SS-7 has no built-in teeth that could harm light wall pipe or fittings. The SS-7 couplings are comprised of two identical CF8 (304) or CF8M (316) housing segments, EPDM or Nitrile gasket and stainless steel track bolts and heavy duty nuts.



The tongue and groove style rigid coupling may allow for rotation of pipe when installed on deeper than specified grooves.

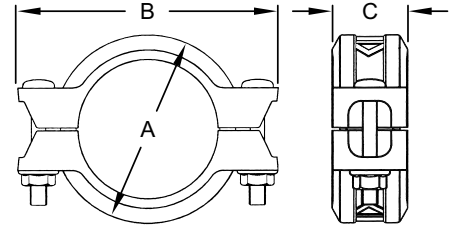

DIMENSIONS

NOMINAL SIZE	PIPE O.D.	MAX. WORKING PRESSURE (CWP)*	MAX END LOAD (CWP)	AXIAL DISPLACEMENT †	DIMENSIONS			BOLT SIZE	WEIGHT
					A	B	C		
in	in	PSI	lb	in	in	in	in	lb	
mm	mm	Bar	kN	mm	mm	mm	mm	kg	
1-1/4	1.660	600	1298	0-0.06	2.68	4.13	1.75	3/8 x 2-1/8	1.5
32	42.2	42	5.77	0-1.6	68	105	45		0.7
1-1/2	1.900	600	1700	0-0.06	2.91	4.25	1.81	3/8 x 2-1/8	1.8
40	48.3	42	7.56	0-1.6	74	108	46		0.8
2	2.375	600	2657	0-0.06	3.39	4.92	1.81	3/8 x 2-1/8	2.0
50	60.3	42	11.82	0-1.6	86	125	46		0.9
2-1/2	2.875	600	3893	0-0.06	3.94	5.43	1.81	3/8 x 2-1/8	1.8
65	73.0	42	17.32	0-1.6	100	138	46		0.8
3	3.500	600	5770	0-0.06	4.41	6.30	1.81	3/8 x 2-1/8	2.6
80	88.9	42	25.67	0-1.6	112	160	46		1.2
4	4.500	600	9538	0-0.13	5.63	8.15	2.00	1/2 x 3	4.6
100	114.3	42	42.43	0-3.2	143	207	51		2.1
5	5.563	600	14576	0-0.13	6.73	9.29	2.00	1/2 x 3	5.9
125	141.3	42	64.84	0-3.2	171	236	51		2.7
6	6.625	600	20672	0-0.13	7.91	10.08	2.00	1/2 x 3	6.8
150	168.3	42	91.96	0-3.2	201	256	51		3.1
8	8.625	600	35038	0-0.13	10.39	13.11	2.44	5/8 x 3-1/2	14.1
200	219.1	42	155.86	0-3.2	264	333	62		6.4

**The working pressure shown is based on roll-grooved Sch. 40S pipe.

† Allowable Axial Displacement and Angular Movement (deflection) figures are for roll grooved standard steel pipe. Values for cut grooved pipe will be double that of roll grooved. These values are maximums; for design and installation purposes these figures should be reduced by: 50% for 3/4"/DN20 - 3-1/2"/DN90; 25% for 4"/DN100 and larger to compensate for jobsite conditions.



The Model SS-7X Stainless Steel Rigid Coupling is a tongue and groove rigid coupling designed to provide a rigid joint for stainless steel pipe in size 10" through 24". The SS-7X is supplied standard in CF8 (304) and CF8M (316) with 304 and 316 bolts and nuts. As an option this coupling can be supplied with small triangular teeth inside the key shoulder to prevent the pipe or component from rotating.



Always fasten the bolts to the required torque.

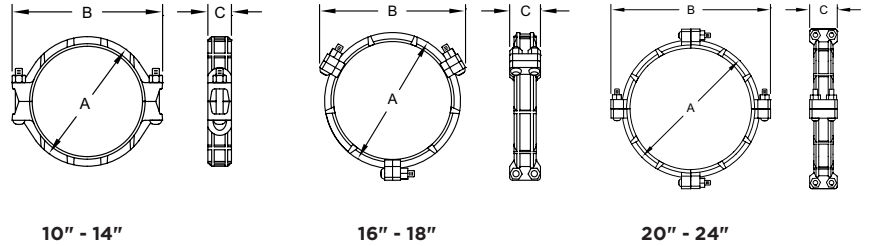

DIMENSIONS

NOMINAL SIZE	PIPE O.D.	MAX. WORKING PRESSURE (CWP)*	MAX. END LOAD (CWP)	AXIAL DISPLACEMENT †	DIMENSIONS			BOLT		BOLT TORQUE	WEIGHT
					A	B	C	No.	SIZE		
in	in	PSI	lb	in	in	in	in			lb-Ft	lb
mm	mm	Bar	kN	mm	mm	mm	mm	No.	in	Nm	kg
10	10.750	600	54430	0-0.13	12.52	15.98	2.56	2	7/8 x 6-1/2	105 - 175	23.1
250	273.0	42	239.87	0-3.2	318	406	65			145 - 235	10.5
12	12.750	600	76567	0-0.13	14.72	17.78	2.56	2	7/8 x 6-1/2	105 - 175	23.3
300	323.9	42	337.66	0-3.2	374	452	65			145 - 235	11.5
14	14.000	400	61544	0-0.13	15.63	19.69	2.95	2	7/8 x 6-1/2	105 - 175	33.0
350	355.6	28	277.94	0-3.2	397	500	75			145 - 235	15.0
16	16.000	400	80384	0-0.13	18.15	21.10	2.95	6	5/8 x 3-1/2	50 - 75	42.7
400	406.4	28	363.02	0-3.2	461	536	75			68 - 100	19.4
18	18.000	350	89019	0-0.13	20.24	23.11	2.95	6	5/8 x 3-1/2	50 - 75	55.0
450	457.2	24	393.82	0-3.2	514	587	75			68 - 100	25.0
20	20.000	350	109900	0-0.13	22.48	26.34	3.11	8	3/4 x 4-3/4	65 - 150	72.8
500	508.0	24	486.19	0-3.2	571	669	79			85 - 200	33.1
22	22.000	300	113982	0-0.13	24.49	28.35	3.11	8	3/4 x 4-3/4	65 - 150	72.6
550	558.8	20	490.24	0-3.2	622	720	79			85 - 200	33.0
24	24.000	300	135648	0-0.13	26.47	30.35	3.11	8	3/4 x 4-3/4	65 - 150	76.3
600	609.6	20	583.43	0-3.2	673	771	79			85 - 200	34.7

**The working pressure shown is based on roll-grooved Sch. 40S pipe.

† Allowable Axial Displacement and Angular Movement (deflection) figures are for roll grooved standard steel pipe. Values for cut grooved pipe will be double that of roll grooved. These values are maximums; for design and installation purposes these figures should be reduced by: 50% for 3/4"/DN20 - 3-1/2"/DN90; 25% for 4"/DN100 and larger to compensate for jobsite conditions.

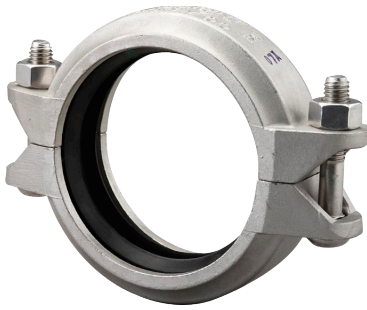

The Model SS-8 is a flexible coupling designed for a variety of general service and specialty applications. The SS-8 is supplied standard in CF8 (304) and CF8M (316) with 304 or 316 bolts and nuts.

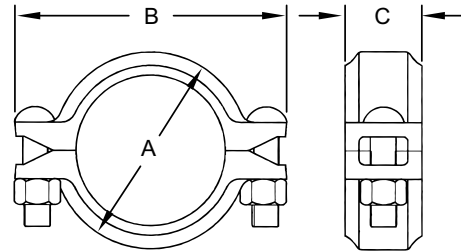

DIMENSIONS

NOMINAL SIZE	PIPE O.D.	MAX. WORKING PRESSURE (CWP)*	MAX. END LOAD (CWP)	AXIAL DISPLACEMENT †	DEFLECTION DEGREE †	DIMENSIONS			BOLT SIZE	WEIGHT
						A	B	C		
in	in	PSI	lb	in	(°)	in	in	in	in	lb
mm	mm	Bar	kN	mm		mm	mm	mm		kg
1	1.315	500	679	0 - 0.06	2° - 45'	2.19	3.45	1.73	5/16 x 1-1/2	1.1
25	33.4	35	3.02	0 - 1.6		55.7	87.5	44.0		0.5
1-1/4	1.660	500	1082	0 - 0.06	2° - 10'	2.54	3.85	1.73	5/16 x 1-1/2	1.1
32	42.2	35	4.81	0 - 1.6		64.6	97.8	44.0		0.5
1-1/2	1.900	500	1417	0 - 0.06	1° - 54'	2.79	4.14	1.73	5/16 x 1-1/2	1.1
40	48.3	35	6.30	0 - 1.6		70.8	105.1	44.0		0.5
2	2.375	500	2214	0 - 0.06	1° - 31'	3.28	4.88	1.73	3/8 x 2-1/8	1.5
50	60.3	35	9.85	0 - 1.6		83.0	124.0	44.0		0.7
2-1/2	2.875	500	3244	0 - 0.06	1° - 15'	3.79	5.51	1.73	3/8 x 2-1/8	1.8
65	73.0	35	14.43	0 - 1.6		96.2	139.9	44.0		0.8
3	3.500	500	4808	0 - 0.06	1° - 02'	4.39	6.18	1.73	3/8 x 2-1/8	2.2
80	88.9	35	21.39	0 - 1.6		111.0	157.0	44.0		1.0
4	4.500	425	5166	0 - 0.13	1° - 36'	5.62	7.87	1.97	1/2 x 3	3.7
100	114.3	29	22.98	0 - 3.2		143.0	200.0	50.0		1.7
5	5.563	425	4859	0 - 0.13	1° - 18'	6.72	8.90	1.97	1/2 x 3	4.8
125	141.3	29	21.61	0 - 3.2		170.8	226.1	50.0		2.2
6	6.625	425	6891	0 - 0.13	1° - 05'	7.80	9.96	2.09	1/2 x 3	6.4
150	168.3	29	30.65	0 - 3.2		198.0	253.1	53.0		2.9
8	8.625	300	11386	0 - 0.13	0° - 50'	10.04	13.27	2.44	5/8 x 3-1/2	14.1
200	219.1	20	50.65	0 - 3.2		255.0	337.0	62.0		6.4

**The working pressure shown is based on roll-grooved Sch. 40S pipe.

† Allowable Axial Displacement and Angular Movement (deflection) figures are for roll grooved standard steel pipe. Values for cut grooved pipe will be double that of roll grooved. These values are maximums; for design and installation purposes these figures should be reduced by: 50% for 3/4"/DN20 - 3-1/2"/DN90; 25% for 4"/DN100 and larger to compensate for jobsite conditions.

SS-8X STAINLESS STEEL HEAVY DUTY FLEXIBLE COUPLING



The Model SS-8X is designed for high pressure applications including reverse osmosis and desalination systems. The SS-8X is available in stainless steel 304, stainless steel 316, Duplex CD3MN (2205), Super Duplex CE8MN, CE3MN (2507) and 6-Moly stainless steel CK3MCuN (2545MO). The SS-8X features 304 or 316 bolts, washers and Silicon Bronze nuts to help prevent galling during repetitive use.

 Ensure coupling bolt pads make metal-to-metal contact.

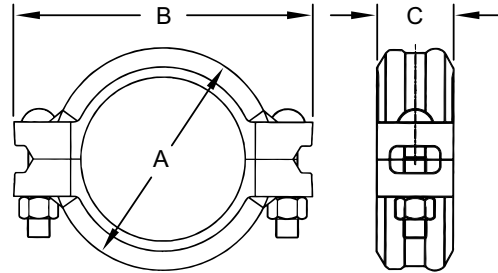

DIMENSIONS

NOMINAL SIZE	PIPE O.D.	MAX. WORKING PRESSURE (CWP)*	MAX. END LOAD (CWP)	AXIAL DISPLACEMENT †	DEFLECTION DEGREE †	DIMENSIONS			BOLT		WEIGHT
						A	B	C	No	SIZE	
in mm	in mm	PSI Bar	lb kN	in mm	(°)	in mm	in mm	in mm		in	lb kg
3/4 20	1.050 26.7	750 52	1212 5.39	0 - 0.06 0 - 1.6	3° - 23'	2.20 56.0	3.75 95.0	1.81 46.0	2	3/8 x 2-1/8	1.5 0.7
1 25	1.315 33.4	750 52	1900 8.45	0 - 0.06 0 - 1.6	2° - 45'	2.45 63.0	3.91 99.0	1.81 46.0	2	3/8 x 2-1/8	1.8 0.8
1-1/4 32	1.660 42.2	750 52	3028 13.47	0 - 0.06 0 - 1.6	2° - 10'	2.82 72.0	4.37 111.0	1.81 46.0	2	3/8 x 2-1/8	2.0 0.9
1-1/2 40	1.900 48.3	750 52	3967 17.65	0 - 0.06 0 - 1.6	1° - 54'	3.06 78.0	4.82 123.0	1.81 46.0	2	3/8 x 2-1/8	2.2 1.0
2 50	2.375 60.3	750 52	6199 27.58	0 - 0.06 0 - 1.6	1° - 31'	3.46 88.0	5.28 134.0	1.85 47.0	2	3/8 x 2-1/8	2.6 1.2
2-1/2 65	2.875 73.0	750 52	9084 40.41	0 - 0.06 0 - 1.6	1° - 15'	6.02 153.0	4.06 103.0	1.85 47.0	2	3/8 x 2-1/8	2.9 1.3
3 80	3.500 88.9	750 52	13463 59.89	0 - 0.06 0 - 1.6	1° - 02'	4.71 120.0	6.74 171.0	1.85 47.0	2	1/2 x 3	4.0 1.8
4 100	4.500 114.3	750 52	22255 99.00	0 - 0.13 0 - 3.2	1° - 36'	5.98 152.0	7.90 201.0	2.03 52.0	2	1/2 x 3	5.3 2.4
5 125	5.563 141.3	750 52	24293 108.07	0 - 0.13 0 - 3.2	1° - 18'	7.13 181.0	9.80 249.0	2.09 53.0	2	5/8 x 3-1/2	7.7 3.5
6 150	6.625 168.3	300 20	34454 153.27	0 - 0.13 0 - 3.2	1° - 05'	8.19 208.0	10.85 276.0	2.09 53.0	2	5/8 x 3-1/2	8.8 4.0
8 200	8.625 219.1	300 20	58397 259.77	0 - 0.13 0 - 3.2	0° - 50'	10.53 267.0	13.43 341.0	2.44 62.0	2	3/4 x 4-3/4	15.0 6.8

**The working pressure shown is based on roll-grooved Sch. 40S pipe.

† Allowable Axial Displacement and Angular Movement (deflection) figures are for roll grooved standard steel pipe. Values for cut grooved pipe will be double that of roll grooved. These values are maximums; for design and installation purposes these figures should be reduced by: 50% for 3/4"/DN20 - 3-1/2"/DN90; 25% for 4"/DN100 and larger to compensate for jobsite conditions.

SS-1200 STAINLESS STEEL HIGH PRESSURE FLEXIBLE COUPLING



The Model SS-1200 is designed for high pressure applications including reverse osmosis, desalination and other specialty systems. The SS-1200 is available in strong and anti-corrosive alloys of Duplex CD3MN (2205), Super Duplex CE8MN, CE3MN (2507) and 6-Moly stainless steel CK3MCuN (254SMO*). The SS-1200 features 316 bolts, washers and silicon bronze nuts to help prevent galling during repetitive use. *254SMO is a registered trademark of Avesta Polarit AB.

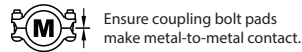

Always use the factory supplied Shurjoint Fast-Fit™ gasket. Performance standards do not support the use of a standard gasket in the SS-1200 coupling.

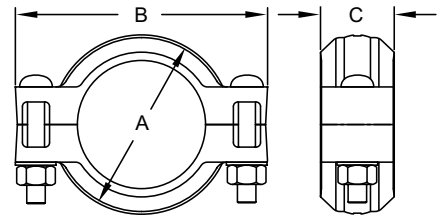

DIMENSIONS

NOMINAL SIZE	PIPE O.D.	MAX. WORKING PRESSURE (CWP)**	MAX. END LOAD (CWP)	AXIAL DISPLACEMENT †	DEFLECTION DEGREE †	DIMENSIONS			BOLT		WEIGHT
						A	B	C	No	SIZE	
in	in	PSI	lb	in	(°)	in	in	in		in	lb
mm	mm	Bar	kN	mm		mm	mm	mm	No		kg
3/4*	1.050	1200	1040	0 - 0.06	3° - 23'	2.09	3.70	1.81	2	3/8 x 2-1/8	0.99
20	26.7	83	4.62	0 - 1.6		53	94	46			0.45
1	1.315	1200	1630	0 - 0.06	2° - 45'	2.36	3.90	1.81	2	3/8 x 2-1/8	1.21
25	33.4	83	7.25	0 - 1.6		60	99	46			0.55
1-1/4	1.660	1200	2595	0 - 0.06	2° - 10'	2.76	4.17	1.81	2	3/8 x 2-1/8	1.39
32	42.2	83	11.55	0 - 1.6		70	106	46			0.63
1-1/2	1.900	1200	3400	0 - 0.06	1° - 54'	2.99	4.45	1.81	2	3/8 x 2-1/8	1.54
40	48.3	83	15.13	0 - 1.6		76	113	46			0.70
2	2.375	1200	5315	0 - 0.06	1° - 31'	3.50	5.31	1.85	2	1/2 x 3	2.29
50	60.3	83	23.64	0 - 1.6		89	135	47			1.04
3	3.500	1200	11540	0 - 0.06	1° - 02'	4.69	6.61	1.85	2	1/2 x 3	3.41
80	88.9	83	51.33	0 - 1.6		119	168	49			1.55
4	4.500	1200	19075	0 - 0.13	1° - 36'	5.79	7.80	2.03	2	5/8 x 3-1/2	4.69
100	114.3	83	84.86	0 - 3.2		147	198	52			2.13

Working pressure ratings are based upon generally accepted pressure piping design standards and testing in accordance with ASME Section VIII Division 1 pressure vessel test methods.

* Non-standard/stock items may require longer lead time.

** The working pressure shown is based on cut-grooved Sch. 40S or 80S pipe only. Burst test pressures are minimum 2 times the maximum working pressures.

† Allowable Axial Displacement and Angular Movement (deflection) figures are for roll grooved standard steel pipe. Values for cut grooved pipe will be double that of roll grooved. These values are maximums; for design and installation purposes these figures should be reduced by: 50% for 3/4"/DN20 - 3-1/2"/DN90; 25% for 4"/DN100 and larger to compensate for jobsite conditions.

FAST-FIT™ GASKET:

Easy installation with a single hand.

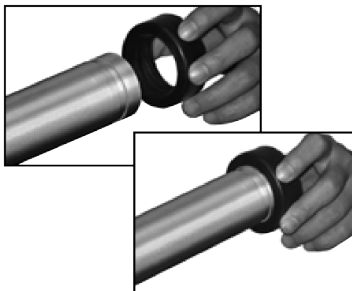

The Shurjoint Fast-Fit™ gasket has been designed and engineered for easier and faster installations. The pipe-end friendly design eliminates struggling to stretch the gasket over the pipe ends and the Fast-Fit™ gasket also features Shurjoint's GapSeal technology, which seals the gap between the pipe ends and eliminates stagnant water pockets within the gasket cavity. The Fast-Fit™ gasket is UL classified in accordance with NSF/ANSI 61 and NSF/ANSI 372 for potable water (Cold Water +86°F / 30°C and Hot Water +180°F / +82°C).

SS-28 STAINLESS STEEL HINGED LEVER COUPLING



The Model SS-28 Hinged Grooved Coupling is designed for quick connect and disconnect services. The housing segments are hinged with a lever handle for easy assembly. Use of the split pin can prevent the accidental opening of the coupling. The Model SS-28 can be used in a wide variety of applications with standard roll- or cut grooved pipe. Housings 1-1/2" - 4" (40 mm - 100 mm) feature a smooth outer surface, housings 5" - 12" (125 mm - 300 mm) feature a cross-ribbed design for added strength. Standard gasket: Grade "E" EPDM or Grade "T" Nitrile. Available standard in CF8 (304) or CF8M (316).

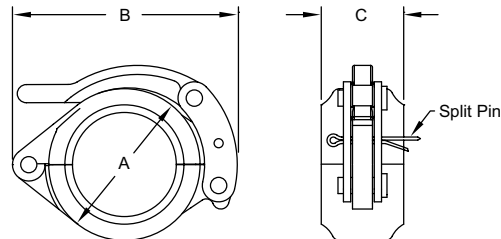

DIMENSIONS

NOMINAL SIZE	PIPE O.D.	MAX. WORKING PRESSURE (CWP)**	MAX END LOAD (CWP)	AXIAL DISPLACEMENT †	DEFLECTION DEGREE †	DIMENSIONS			WEIGHT
						A	B	C	
in	in	PSI	lb	in	(°)	in	in	in	lb
mm	mm	Bar	kN	mm		mm	mm	mm	Kg
1-1/2*	1.900	300	1700	0 - 0.06	3° - 48'	2.95	4.65	1.85	2.2
40	48.3	20	7.56	0 - 1.6		75	118	47	1.0
2	2.375	300	2657	0 - 0.06		3.39	4.76	1.89	2.4
50	60.3	20	11.82	0 - 1.6	3° - 31'	86	121	48	1.1
2-1/2*	2.875	300	3893	0 - 0.06	2° - 30'	3.62	5.91	1.89	3.1
65	73.0	20	17.32	0 - 1.6		92	150	48	1.4
3	3.500	300	5770	0 - 0.06		4.69	6.42	1.89	4.0
80	88.9	20	25.67	0 - 1.6	2° - 24'	119	163	48	1.8
4	4.500	300	9538	0 - 0.13		6.50	8.07	2.05	5.9
100	114.3	20	42.43	0 - 3.2	3° - 12'	165	205	52	2.7
5	5.563	200	9717	0 - 0.13		7.44	9.96	2.05	10.8
125	141.3	14	43.23	0 - 3.2	2° - 36'	189	253	52	4.9
6	6.625	200	13782	0 - 0.13		8.50	11.06	2.05	12.8
150	168.3	14	61.31	0 - 3.2	2° - 10'	216	281	52	5.8

**The working pressure shown is based on roll-grooved Sch. 40S pipe.

† Allowable Axial Displacement and Angular Movement (deflection) figures are for roll grooved standard steel pipe. Values for cut grooved pipe will be double that of roll grooved. These values are maximums; for design and installation purposes these figures should be reduced by: 50% for 3/4"/DN20 - 3-1/2"/DN90; 25% for 4"/DN100 and larger to compensate for jobsite conditions.

EXPANSION PIPE

Lever handles are factory assembled pretty tight for safety sake. The use of expansion pipes may be used to assist in closing and opening of the coupling.



EXPANSION PIPE SIZE	APPLICABLE COUPLING SIZES
1/2" x 6"	1-1/2" ~ 4"
3/4" x 8"	5" ~ 8"

(You can easily make your expansion pipe simply by cutting sch. 40 1/2" or 3/4" pipe to a proper length)

CAST GROOVED FITTINGS

SS-10 90° elbow | SS-20 tee
 SS-11 45° elbow | SS-60 cap



The Shurjoint Model SS-10, SS-11, SS-20 and SS-60 stainless steel grooved fittings are investment cast in sizes 1"-8" and sand cast or wrought in 10" and 12". These fittings are supplied in ASTM A351 or A743 austenitic grades CF8 (304) and CF8M (316). Materials are in compliance with NSF/ANSI 372 for potable water service applications.

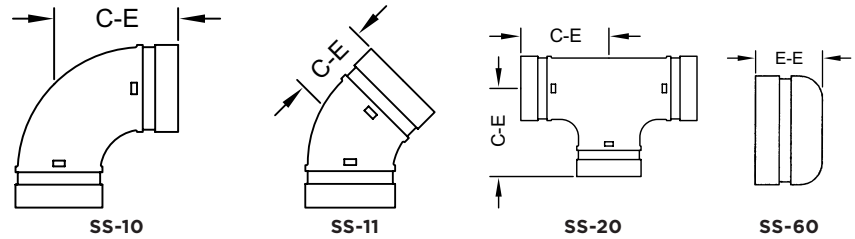

DIMENSIONS Not all sizes may be UL / FM listed. See publication B-24 for details.

NOMINAL SIZE	PIPE O.D.	SS-10 90° ELBOW		SS-11 45° ELBOW		SS-20 TEE		SS-60 CAP	
		C - E	WEIGHT	C - E	WEIGHT	C - E	WEIGHT	E - E	WEIGHT
in	in	in	lb	in	lb	in	lb	in	lb
mm	mm	mm	Kg	mm	Kg	mm	Kg	mm	Kg
1	1.315	2.25	0.7	1.75	0.4	2.25	0.9	0.94	0.2
25	33.4	57	0.3	45	0.2	57	0.4	24	0.1
1-1/4	1.660	2.75	0.9	1.75	0.7	2.75	1.5	0.94	0.2
32	42.2	70	0.4	45	0.3	70	0.7	24	0.1
1-1/2	1.900	2.75	0.9	1.75	0.9	2.75	1.8	0.94	0.4
40	48.3	70	0.4	45	0.4	70	0.8	24	0.2
2	2.375	3.25	1.3	2.00	1.1	3.25	2.4	0.94	0.4
50	60.3	83	0.6	51	0.5	83	1.1	24	0.2
2-1/2	2.875	3.75	3.1	2.10	2.2	3.75	5.5	1.75	0.9
65	73.0	95	1.4	54	1.0	95	2.5	45	0.4
3	3.500	4.25	2.9	2.50	2.2	4.25	4.6	2.00	1.5
80	88.9	108	1.3	64	1.0	108	2.1	51	0.7
4	4.500	5.00	4.8	3.00	3.5	5.00	7.5	2.00	2.0
100	114.3	127	2.2	76	1.6	127	3.4	51	0.9
5	5.563	5.50	8.6	3.25	6.4	5.50	12.8	2.38	3.3
125	141.3	140	3.9	83	2.9	140	5.8	60	1.5
6	6.625	6.50	14.3	3.50	9.2	6.50	21.3	3.00	5.3
150	168.3	165	6.5	89	4.2	165	9.7	76	2.4
8	8.625	7.75	23.5	4.25	15.6	7.75	41.4	3.50	11.4
200	219.1	197	10.7	108	7.1	197	18.8	90	5.2
10	10.750	9.25*	41.8	6.25	37.0	9.00*	46.4	5.00	22.4
250	273.0	234	19.0	159	16.8	229	21.1	127	10.2
12	12.750	10.00*	83.6	7.50*	43.1	10.00*	94.6	6.00	32.3
300	323.9	254	38.0	191	19.6	254	43.0	154	15.4

CAST GROOVED FITTINGS

SS-21 Reducing tee
 SS-50 Concentric reducer



The Shurjoint Model SS-21, SS-50 stainless steel fittings are investment cast in sizes to 8" and sand cast or wrought in sizes 10" and 12". Materials are in compliance with NSF/ANSI 372 for potable water service applications.

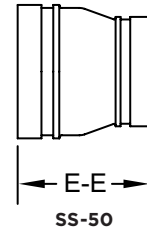
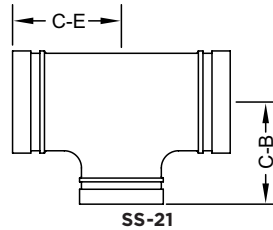

DIMENSIONS Not all sizes may be UL / FM listed. See publication B-24 for details.

NOMINAL SIZE	PIPE O.D.	SS-21 REDUCING TEE			SS-50 CONCENTRIC REDUCER	
		C-E	C-B	WEIGHT	E-E	WEIGHT
in	in	in	in	lb	in	lb
mm	mm	mm	mm	kg	mm	kg
1-1/4 x 1	1.660 x 1.315	2.75	2.75	1.2	2.50	0.5
30 x 25	42.2 x 33.4	70	70	0.6	64	0.2
1-1/2 x 1	1.900 x 1.315	2.75	2.75	1.3	2.50	0.6
40 x 25	48.3 x 33.4	70	70	0.6	64	0.3
1-1/2 x 1-1/4	1.900 x 1.660	2.75	2.75	1.3	2.50	0.7
40 x 32	48.3 x 42.2	70	70	0.6	64	0.3
2 x 1	2.375 x 1.315	2.75	2.75	1.5	2.50	0.8
50 x 25	60.3 x 33.4	70	70	0.7	64	0.3
2 x 1-1/4	2.375 x 1.660	2.75	2.75	1.8	2.50	0.7
50 x 32	60.3 x 42.2	70	70	0.8	64	0.7
2 x 1-1/2	2.375 x 1.900	2.75	2.75	1.8	2.50	0.7
50 x 40	60.3 x 48.3	70	70	0.8	64	0.3
2-1/2 x 1	2.875 x 1.315	3.74	3.74	2.0	2.50	0.9
65 x 25	73.0 x 33.4	95	95	0.9	64	0.4
2-1/2 x 1-1/4	2.875 x 1.660	3.74	3.74	2.0	2.50	1.1
65 x 32	73.0 x 42.2	95	95	0.9	64	0.5
2-1/2 x 1-1/2	2.875 x 1.900	3.74	3.74	2.0	2.50	1.2
65 x 40	73.0 x 48.3	95	95	0.9	64	0.5
2-1/2 x 2	2.875 x 2.375	3.00	3.00	4.1	2.50	1.1
65 x 50	73.0 x 60.3	76	76	1.9	64	0.5
3 x 1-1/4	3.500 x 1.660	4.25	4.25	3.5	2.50	1.1
80 x 32	88.9 x 42.2	108	108	1.6	64	0.5
3 x 1-1/2	3.500 x 1.900	4.25	4.25	2.9	2.50	1.5
80 x 40	88.9 x 48.3	108	108	1.3	64	0.6
3 x 2	3.500 x 2.375	4.25	4.25	4.6	2.50	1.3
80 x 50	88.9 x 60.3	108	108	2.1	64	0.6
3 x 2-1/2	3.500 x 2.875	3.74	3.27	6	3.50	2.2
80 x 65	88.9 x 73.0	95	83	2.7	89	1.0
4 x 2	4.500 x 2.375	5.00	5.00	7.3	3.00	2.2
100 x 50	114.3 x 60.3	127	127	3.3	76	1.0
4 x 2-1/2	4.500 x 2.875	4.49	3.86	8.8	4.00	3.1
100 x 65	114.3 x 73.0	114	98	4	102	1.4
4 x 3	4.500 x 3.500	4.49	3.86	7	3.00	2.2
100 x 80	114.3 x 88.9	114	98	3.2	76	1.0
139.7 x 100 mm	5.500 x 4.500	5.5	5.5	11.2	3.50	3.5
125 x 100	139.7 x 114.3	140	140	5.1	89	1.6
5 x 4	5.563 x 4.500	5.5	5.5	11.2	3.50	3.5
125 x 100	141.3 x 114.3	140	140	5.1	89	1.6
6 x 3	6.625 x 3.500	5.91	5.91	15.6	4.00	5.1
150 x 80	168.3 x 88.9	150	150	7.1	102	2.3
6 x 4	6.625 x 4.500	6.50	6.50	19.4	4.00	5.1
150 x 100	168.3 x 114.3	165	165	8.8	102	2.3
6 x 5	6.625 x 5.563	6.50	6.50	19.4	4.00	5.7
150 x 125	168.3 x 141.3	165	165	8.8	102	2.6

NOMINAL SIZE	PIPE O.D.	SS-21 REDUCING TEE			SS-50 CONCENTRIC REDUCER	
		C-E	C-B	WEIGHT	E-E	WEIGHT
in	in	in	in	lb	in	lb
mm	mm	mm	mm	kg	mm	kg
8 x 4	8.625 x 4.500	7.76	7.76	35.4	5.00	9.5
200 x 100	219.1 x 114.3	197	197	16.1	127	4.3
8 x 5	8.625 x 5.563	7.76	7.76	28.6	5.00	11.9
200 x 125	219.1 x 141.3	197	197	13	127	5.4
8 x 6	8.625 x 6.625	7.76	7.76	54.1	5.00	9.5
200 x 150	219.1 x 168.3	197	197	24.6	127	4.3
10 x 6	10.750 x 6.625	9.02	9.02	59.2	6.00	18.3
250 x 150	273.0 x 168.3	229	229	26.9	152	8.3
10 x 8	10.750 x 8.625	9.02	9.02	60.1	6.00	19.1
250 x 200	273.0 x 219.1	229	229	27.3	152	8.7
12 x 8	12.750 x 8.625	10*	10	56.1	7.00	49.5
300 x 200	323.9 x 219.1	254	254	25.5	178	22.0
12 x 10	12.750 x 10.750	10*	10	57.2	7.00	23.1
300 x 250	323.9 x 273.0	254	254	26	178	11.3



The Shurjoint Model SS-21F & SS-50F stainless steel fittings are investment cast and provide a female NPT connection on the reduced branch. Materials are in compliance with NSF/ANSI 61 and 372 for potable water service applications.

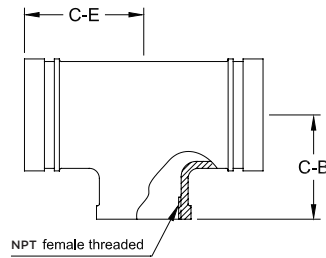

SS-21F

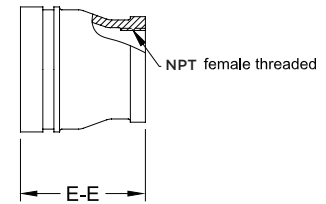

SS-50F

DIMENSIONS

NOMINAL SIZE	PIPE O.D.	SS-21F REDUCING TEE			SS-50F CONCENTRIC REDUCER	
		C-E	C-B	WEIGHT	E-E	WEIGHT
in	in	in	in	lb	in	lb
mm	mm	mm	mm	kg	mm	kg
2" x 1"	2.375 x 1.315	3.27	3.27	4.0	-	-
50 x 30	60.3 x 33.4	83	83	1.8	-	-
2" x 1½"	2.375 x 1.900	3.27	3.27	4.0	-	-
50 x 40	60.3 x 33.4	83	83	1.8	-	-
2½" x 2"	2.875 x 2.375	3.74	3.74	9.0	3.50	2.4
65 x 50	73.0 x 60.3	95	95	4.1	89	1.1
3" x 2"	3.500 x 2.375	3.74	3.27	10.1	3.50	2.4
80 x 50	88.9 x 60.3	95	83	4.6	89	1.3
4" x 2"	4.500 x 2.375	4.50	3.63	16.1	4.00	7.7
100 x 50	114.3 x 60.3	114	92	7.3	102	3.5
6" x 2"	6.625 x 2.375	6.50	6.50	27.1	-	-
150 x 50	168.3 x 60.3	165	165	12.3	-	-

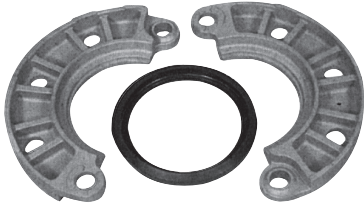

The Model SS-41 stainless steel flange adapter allows for a direct connection with ANSI Class 125/150 flanges. The specially designed gasket allows for the transition from a grooved system to a flanged system or component with a single flange. The SS-41 is investment cast in grades CF8 (304), CF8M (316). Integral closure tabs located on the flange O.D. help to facilitate alignment and assembly. Stainless Steel Sandwich Plates available.

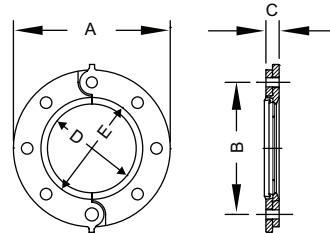

2" - 12"

DIMENSIONS

Not all sizes may be FM listed. See publication B-24 for details.

NOMINAL SIZE	PIPE O.D.	MAX. WORKING PRESSURE (CWP)*	MAX. END LOAD (CWP)	DIMENSIONS			SEATING SURFACE		BOLT		WEIGHT
				A	B	C	D	E	No.	SIZE	
in	in	PSI	lb	in	in	in	in	in			lb.
mm	mm	Bar	kN	mm	mm	mm	mm	mm			kg
2	2.375	300	1330	6.00	4.75	0.75	2.28	3.07	4	5/8 x 3	4.6
50	60.3	20	5.71	152	121	19	58	78			2.1
2-1/2	2.875	300	1950	7.00	5.50	0.87	2.72	3.54	4	5/8 x 3	6.0
65	73.0	20	8.37	178	140	22	69	90			2.7
3	3.500	300	2880	7.52	6.00	0.94	3.35	4.17	4	5/8 x 3	6.8
80	88.9	20	12.41	191	152	24	85	106			3.1
4	4.500	300	4770	9.00	7.50	0.94	4.33	5.20	8	5/8 x 3	9.9
100	114.3	20	20.51	229	191	24	110	132			4.5
6	6.625	300	10340	11.00	9.50	1.00	6.46	7.32	8	3/4 x 3-1/2	12.9
150	168.3	20	44.47	279	241	25	164	186			5.8
8	8.625	300	17520	13.50	11.75	1.14	8.46	9.29	8	3/4 x 3-1/2	20.2
200	219.1	20	75.37	343	298	29	215	236			9.2

*The working pressure shown is based on roll-grooved Sch. 40S pipe.

SS-80 STAINLESS STEEL UNIVERSAL FLANGE ADAPTER

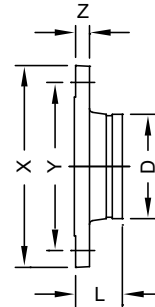
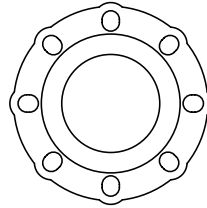

DIMENSIONS Not all sizes may be FM listed. See publication B-24 for details..

NOMINAL SIZE	PIPE O.D.	L	X	Y: FLANGE DRILLING				Z	BOLT				WEIGHT
				ANSI 125 / 150	PN 10	PN16	JIS 10K		ANSI 125 / 150	PN 10	PN16	JIS 10K	
in	in	in	in	in	in	in	in	Size	Size	Size	Size	lb.	
mm	mm	mm	mm	mm	mm	mm	mm	No.	No.	No.	No.	kg	
2	2.375	2.50	6.50	4.75	4.92	4.92	4.72	5/8	M16	M16	M16	4.4	
50	60.3	64	165	121	125	125	120	16	4	4	4	2.0	
2-1/2*	2.875	3.00	7.28	5.50	5.70	5.70	5.50	0.63	5/8	---	---	---	6.4
65	73.0	76	185	140	145	145	140	16	4	---	---	---	2.9
3	3.500	2.95	7.78	6.00	6.30	6.30	5.90	0.63	5/8	M16	M16	M16	7.5
80	88.9	75	200	152	160	160	150	16	8	8	8	8	3.4
4	4.500	2.95	8.86	7.50	7.09	7.09	6.89	0.63	5/8	M16	M16	M16	8.6
100	114.3	75	225	191	180	180	175	16	8	8	8	8	3.9
5	5.563	2.95	10.00	8.50	8.27	8.27	8.27	0.87	3/4	---	---	---	14.7
125	141.3	75	254	216	210	210	210	22	8	---	---	---	6.7
6	6.625	2.95	10.71	9.50	9.45	9.45	9.45	0.63	3/4	---	---	---	15.2
150	168.3	75	272	241	240	240	240	16	8	---	---	---	6.9
8	8.625	4.00	13.50	11.75	11.61	11.61	---	0.87	3/4	M20	M20	---	31.9
200	219.1	102	343	298	295	295	---	22	8	8	16	---	14.5
10	10.750	3.94	16.00	14.25	13.77	14.00	14.00	1.18	7/8	M20	M24	M22	49.6
250	273.0	100	406	362	350	355	355	30	12	12	12	12	22.5
12*	12.750	4.45	19.00	17.00	15.75	16.14	---	1.26	7/8	M20	M24	---	65.9
300	323.9	113	483	432	400	410	---	32	12	12	12	---	29.9



The Shurjoint Model SS-723 stainless steel mechanical tee is the ideal fitting for branch or direct outlet connections to sprinkler heads, drop nipples and or gauges on stainless steel pipe. No need for welding, simply cut or drill a hole at the desired location, position the housing so that the locating collar fits within the hole and secure with the bolts and nuts. The SS-723 is comprised of stainless steel investment cast housings, EPDM gasket and stainless steel track bolts and nuts. The SS-723 is available in grades CF8 (304) and CF8M (316). Additional sizes and or grades are available on request, please contact for Shurjoint for details.

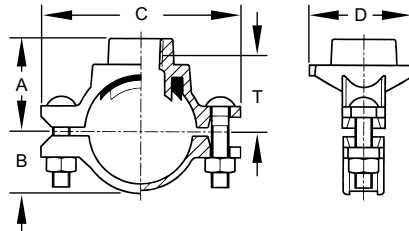

DIMENSIONS

NOMINAL SIZE RUN X BRANCH	MAX. WORKING PRESSURE (CWP)*	HOLE DIA. +0.063, -0 / +1.6, -0	DIMENSIONS					BOLT SIZE	WEIGHT
			A	B	C	D	T‡		
in	PSI	in	in	in	in	in	in	in	lb
mm	Bar	mm	mm	mm	mm	mm	mm	mm	kg
1-1/4 x 1/2	300	1.18	1.60	1.02	3.44	1.93	1.06	5/16 x 1-1/2	0.7
32 x 15	20	30	41	26	87	49	27		0.3
1-1/4 x 3/4	300	1.18	1.70	1.02	3.44	1.93	1.14	5/16 x 1-1/2	0.7
32 x 20	20	30	44	26	87	49	29		0.3
1-1/4 x 1	300	1.18	2.00	1.02	3.44	1.93	1.34	5/16 x 1-1/2	0.9
32 x 25	20	30	51	26	87	49	34		0.4
1-1/2 x 1/2	300	1.18	1.70	1.13	3.54	1.93	1.18	5/16 x 1-1/2	0.7
40 x 15	20	30	44	29	90	49	30		0.3
1-1/2 x 3/4	300	1.18	1.81	1.13	3.54	1.93	1.22	5/16 x 1-1/2	0.7
40 x 20	20	30	46	29	90	49	31		0.3
1-1/2 x 1	300	1.18	2.09	1.13	3.54	1.93	1.42	5/16 x 1-1/2	0.9
40 x 25	20	30	53	29	90	49	36		0.4
2 x 1/2	300	1.18	2.00	1.42	4.28	2.00	1.46	5/16 x 1-1/2	1.1
50 x 15	20	30	51	36	109	51	37		0.5
2 x 3/4	300	1.18	2.09	1.42	4.28	2.00	1.10	5/16 x 1-1/2	1.1
50 x 20	20	30	53	36	109	51	28		0.5
2 x 1	300	1.18	2.37	1.42	4.28	2.00	1.69	5/16 x 1-1/2	1.4
50 x 25	20	30	60	36	109	51	43		0.6

*Working pressure is based on standard wall stainless steel pipe.

‡Hole diameters listed are suggested hole diameters.

‡T: Take-out (Center of run to end of pipe to be engaged)

SS-726 STAINLESS STEEL Y-STRAINER

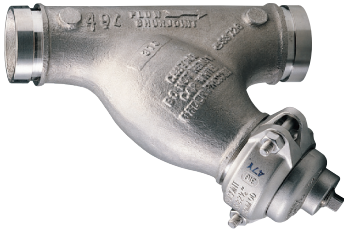

The Model SS-726 316 Stainless Steel Grooved-end Y-Strainers are designed to strain debris and foreign matter from piping systems and thus provide inexpensive protection for costly pumps, meters and other components. The SS-726 Stainless Steel Y-Strainer can be installed quickly and easily with two mechanical couplings and the straight flow design provides for lower pressure drop. This strainer features a stainless steel screen that is secured with an end cap and mechanical coupling. Cleaning and maintenance of the screen can be accomplished easily by removing the coupling. The Model SS-726 Stainless Steel Y-Strainer is suitable for vertical or horizontal installations.

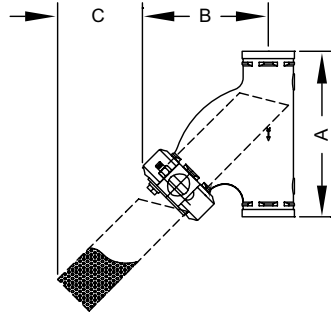

DIMENSIONS

NOMINAL SIZE	PIPE O.D.	MAX. WORKING PRESSURE (CWP)*	DIMENSIONS			DRAIN PLUG SIZE	WEIGHT
			A	B	C		
in	in	PSI	in	in	in	in	lb
mm	mm	Bar	mm	mm	mm	mm	kg
2-1/2	2.875	300	10.75	7.83	4.80	1/2	16.7
65	73.0	20	273	199	122	15	7.6
3	3.500	300	11.75	8.70	5.08	1/2	18.9
80	88.9	20	299	221	129	15	8.6
4	4.500	300	14.25	10.59	6.61	1	21.1
100	114.3	20	362	269	168	25	9.6
6	6.625	300	18.50	14.05	8.62	1	85.8
150	168.3	20	470	357	219	25	39.0

*Working pressure is based on connection with roll- or cut-grooved standard wall stainless steel pipe.



The Model SJ-600L is a stainless steel, grooved-end, two-piece, full port ball valve designed and tested in conformance with MSS SP-110 and SP-72. The lever handle is equipped with tamper resistant locking holes. The SJ-600L is comprised of a stainless steel body and end cap, virgin TFE seats and stainless steel trim. The valve is supplied standard in CF8M (316).

The Model SJ-600 can be also supplied with a worm gear operator. The standard gear operator is supplied with a bracket and extension sleeve. The ISO 5211 mounting pad allows for mounting of other power actuators.

DIMENSIONS

SJ-600L

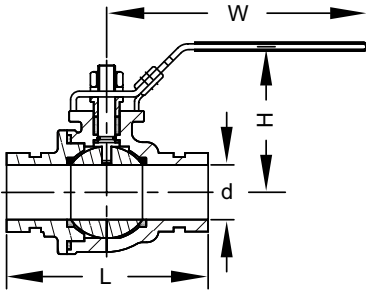

NOMINAL SIZE	PIPE O.D.	MAX. WORKING PRESSURE (CWP)*	OPERATING TORQUE †	DIMENSIONS				WEIGHT [^]
				L	H	W	D	
in	in	PSI	lb-in	in	in	in	in	lb
mm	mm	Bar	Nm	mm	mm	mm	mm	kg
1-1/2	1.900	600	265	5.50	3.70	7.60	1.50	6.6
40	48.3	42	30	140	94	193	38	3.0
2	2.375	600	354	6.15	4.13	7.60	1.97	8.8
50	60.3	42	40	156	105	193	50	4.0
2-1/2	2.875	600	442	7.09	4.33	9.84	2.56	15.4
65	73.0	42	50	180	110	250	65	7.0
3	3.500	600	619	8.42	6.00	9.84	3.07	20.7
80	88.9	42	70	214	152	250	78	9.4
4	4.500	600	973	9.45	6.57	11.42	3.94	55.0
100	114.3	42	110	240	167	290	100	25.0

* Working pressure is for connection with cut- or roll-grooved schedule Sch. 40S pipe.

† For the first opening or closing of the valve when the valve is not continuously operated, an additional torque of 2.0 – 2.5 times the listed operating torque is normally required.

[^]The weight includes the lever handle.



DIMENSIONS

SJ-600W GEAR OPERATOR

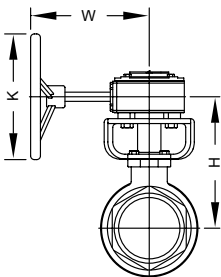

NOMINAL SIZE	PIPE O.D.	DIMENSIONS			WEIGHT
		K	H	W	
in	in	in	in	in	lb
mm	mm	mm	mm	mm	kg
2	2.375	5.98	5.38	8.00	17.82
50	60.3	152	137	203	8.10
2-1/2	2.875	5.98	5.68	8.00	24.42
65	73.0	152	145	203	11.10
3	3.500	5.98	7.16	8.00	29.70
80	88.9	152	182	203	13.50
4	4.500	5.98	8.00	8.00	63.80
100	114.3	152	203	203	29.0

DIMENSIONS

SJ-600W GEAR OPERATOR AND BRACKET

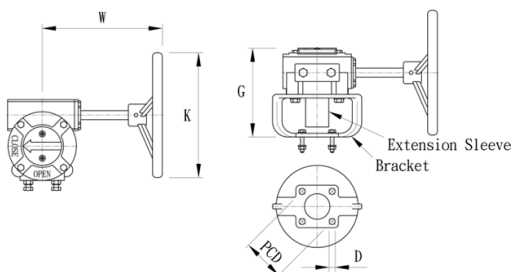

NOMINAL SIZE	DIMENSIONS					WEIGHT
	W	K	G	PCD	D	
in	in	in	in	in	in	lb
mm	mm	mm	mm	mm	mm	kg
1-1/2	8	5.98	5.35	1.64	0.31	11
40	203	152	136	42	8	5
2	8	5.98	5.35	1.97	0.31	11
50	203	152	136	50	8	5
2-1/2	8	5.98	5.35	1.97	0.31	11
65	203	152	136	50	8	5
3	8	5.98	5.55	2.75	0.4	15
80	203	152	141	70	10	7
4	8	5.98	5.55	2.75	0.4	15
100	203	152	141	70	10	7



SJ-400W
2" - 8"



SJ-400L
2" - 8"



DIMENSIONS

SJ-400L

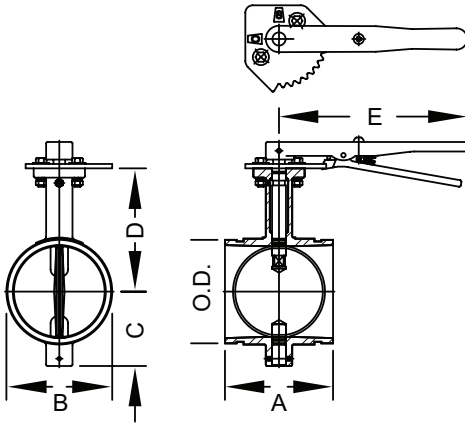

NOMINAL SIZE	PIPE O.D.	MAX. WORKING PRESSURE (CWP)*	DIMENSIONS					OPERATING TORQUE	WEIGHT ^Δ
			A	B	C	D	E		
in	in	PSI	in	in	in	in	in	lb-in	lb
mm	mm	Bar	mm	mm	mm	mm	mm	Nm	kg
2	2.375	300	3.19	2.52	2.48	4.17	7.56	78	5
50	60.3	20	81	64	63	106	192	8.8	2.3
2-1/2	2.875	300	3.81	3.15	2.677	4.28	7.56	84	7
65	73	20	97	80	68	111	192	9.5	3.2
3	3.5	300	3.81	3.622	2.992	4.97	7.56	95	6.6
80	88.9	20	97	92	76	126	192	10.7	3.5
4	4.5	300	4.56	4.646	3.504	5.33	9.92	200	11
100	114.3	20	116	118	89	135	252	22.6	5
6	6.625	300	5.81	6.772	4.488	7.25	13.46	310	20.2
150	168.3	20	148	172	114	184	342	34.9	9.2
8	8.625	300	5.24	8.74	5.512	8.2	13.46	400	26.8
200	219.1	20	133	222	140	208	342	45.1	12.2
10	10.75	150	6.3	11.16	7.32	9.25	14.02	1500	31.3
250	273	10	160	284	186	235	356	170	28.3
12	12.75	150	6.56	13.15	6.39	10.24	14.02	2000	66
300	323.9	10	166	334	213	260	356	226	40

* Working pressure is for connection with cut- or roll-grooved schedule Sch. 405 pipe.
^ΔThe weight includes the lever handle.

DIMENSIONS

SJ-400W

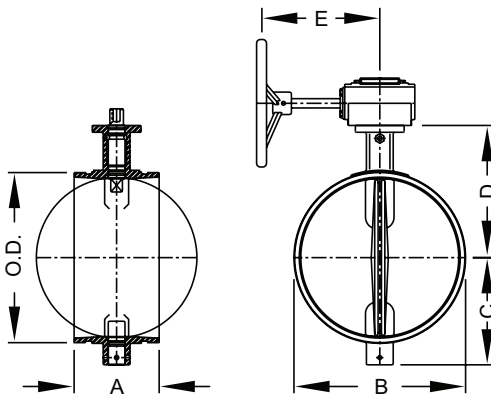

NOMINAL SIZE	PIPE O.D.	MAX. WORKING PRESSURE (CWP)*	DIMENSIONS					OPERATING TORQUE	WEIGHT ^Δ
			A	B	C	D	E		
in	in	PSI	in	in	in	in	in	lb-in	lb
mm	mm	Bar	mm	mm	mm	mm	mm	Nm	kg
2	2.375	300	3.19	2.520	2.480	4.17	6.00	6.00	11.0
50	60.3	20	81	64	63	106	152	152	5.0
2-1/2	2.875	300	3.81	3.150	2.677	4.28	6.00	6.00	13.0
65	73.0	20	97	80	68	111	152	152	5.9
3	3.500	300	3.81	3.622	2.992	4.97	6.00	6.00	12.6
80	88.9	20	97	92	76	126	152	152	5.7
4	4.500	300	4.56	4.646	3.504	5.33	6.00	6.00	17.0
100	114.3	20	116	118	89	135	152	152	7.7
6	6.625	300	5.81	6.772	4.488	7.25	6.00	6.00	26.2
150	168.3	20	148	172	114	184	152	152	11.9
8	8.625	300	5.24	8.740	5.512	8.20	6.00	6.00	32.8
200	219.1	20	133	222	140	208	152	152	14.8
10	10.750	150	6.30	11.16	7.320	9.25	8.00	8.00	42.3
250	273.0	10	160	284	186	235	203	203	19.2
12	12.750	150	6.56	13.15	6.390	10.24	8.00	8.00	77.0
300	323.9	10	166	334	213	260	203	203	34.9

* Working pressure is for connection with cut- or roll-grooved schedule Sch. 405 pipe.
^ΔThe weight includes the lever handle.

The following tables show maximum cold working pressures (CWP) of Shurjoint stainless steel couplings used on stainless steel pipes. In general it is more difficult to achieve defined groove corners on stainless steel pipe than on carbon steel pipe. Always select the correct roll set for the pipe being grooved and process grooves as defined as possible. Contact your roll-groove tool manufacturer for recommendations.

MODEL SS-8 FLEXIBLE COUPLING

NOM. SIZE	CUT-GROOVED		ROLL-GROOVED	
	SCH. 40S	SCH. 40S	SCH. 10S	SCH. 5S
in	psi	psi	psi	psi
mm	Bar	Bar	Bar	Bar
1	500	500	450	200
25	35	35	31	14
1-1/4	500	500	450	200
32	35	35	31	14
1-1/2	500	500	450	200
40	35	35	31	14
2	500	500	450	200
50	35	35	31	14
2-1/2	500	500	450	200
65	35	35	31	14
3	500	500	450	150
80	35	35	31	10
4	425	400	300	200
100	29	28	20	14
5	425	400	250	125
125	29	28	17	9
6	425	400	200	125
150	29	28	14	9
8	300	200	200	125
200	20	14	14	9

MODEL SS-7 RIGID COUPLING

NOM. SIZE	CUT-GROOVED		ROLL-GROOVED	
	SCH. 40S	SCH. 40S	SCH. 10S	SCH. 5S
in	psi	psi	psi	psi
mm	Bar	Bar	Bar	Bar
1-1/4	750	750	500	200
32	52	52	35	14
1-1/2	750	750	500	200
40	52	52	35	14
2	600	600	500	200
50	42	42	35	14
2-1/2	600	600	500	200
65	42	42	35	14
3	600	600	500	200
80	42	42	35	14
4	600	600	400	200
100	42	42	28	14
5	600	600	350	200
125	42	42	24	14
6	600	600	300	200
150	42	42	21	14
8	600	600	300	200
200	42	42	21	14

MODEL SS-8X HEAVY DUTY FLEXIBLE COUPLING

NOM. SIZE	CUT-GROOVED		ROLL-GROOVED	
	SCH. 40S	SCH. 40S	SCH. 10S	SCH. 5S
in	psi	psi	psi	psi
mm	Bar	Bar	Bar	Bar
3/4	750	750	500	225
20	52	52	35	15
1	750	750	500	225
25	52	52	35	15
1-1/4	750	750	500	225
32	52	52	35	15
1-1/2	750	750	500	225
40	52	52	35	15
2	750	750	500	225
50	52	52	35	15
2-1/2	750	750	500	225
65	52	52	35	15
3	750	750	500	225
80	52	52	35	15
4	750	750	400	200
100	52	52	28	14
5	450	450	350	200
125	31	31	24	14
6	450	450	300	200
150	31	31	21	14
8	300	300	300	200
200	21	21	21	14

MODEL SS-7X RIGID COUPLING

NOM. SIZE	CUT-GROOVED		ROLL-GROOVED	
	SCH. 40S	SCH. 40S	SCH. 10S	SCH. 5S
in	psi	psi	psi	psi
mm	Bar	Bar	Bar	Bar
10	600	600	300	200
250	42	41.37	20.68	14
12	600	600	300	200
300	42	41.37	20.68	14
14	400	400	300	NA
350	28	28	20	NA
16	400	400	300	NA
400	28	28	20	NA
18	350	350	300	NA
450	24	24	20	NA
20	350	350	300	NA
500	24	24	20	NA
22	300	300	300	NA
550	20	20	20	NA
24	300	300	300	NA
600	20	20	20	NA

MODEL SS-28 HINGED LEVER COUPLING

NOM. SIZE	CUT-GROOVED		ROLL-GROOVED	
	SCH. 40S	SCH. 40S	SCH. 10S	SCH. 5S
in	psi	psi	psi	psi
mm	Bar	Bar	Bar	Bar
1-1/2	300	300	300	200
40	20	20	20	14
2	300	300	300	200
50	20	20	20	14
2-1/2	300	300	300	200
65	20	20	20	14
3	300	300	300	200
80	20	20	20	14
4	300	300	300	200
100	20	20	20	14
5	200	200	200	125
125	14	14	14	9
6	200	200	200	125
150	14	14	14	9



**valves & flow control
components**

Shurjoint offers a wide range of grooved-end butterfly valves, ball valves, check valves, suction diffusers, strainers and expansion joints. Grooved-end valves and components can be installed 3 – 4 times faster than comparable flange components. With the removal of just a few bolts one can easily access the system for cleaning, maintenance, changes and or system expansion.

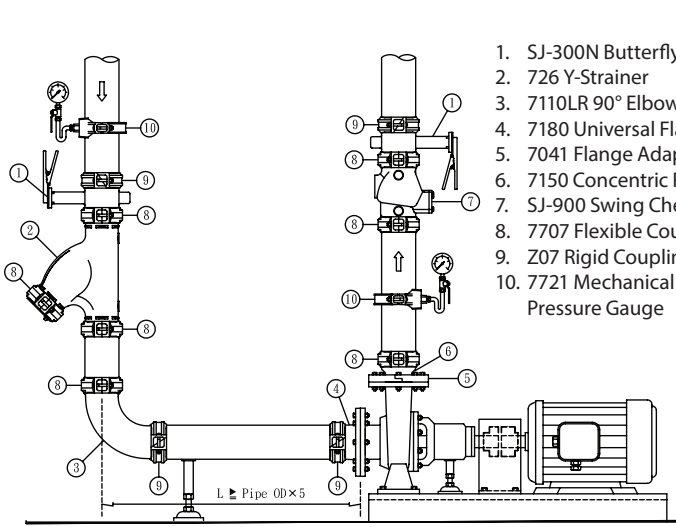

Sample installation without Suction Diffuser.

1. SJ-300N Butterfly Valve
2. 726 Y-Strainer
3. 7110LR 90° Elbow
4. 7180 Universal Flange Adapter
5. 7041 Flange Adapter
6. 7150 Concentric Reducer
7. SJ-900 Swing Check Valve
8. 7707 Flexible Coupling
9. Z07 Rigid Coupling
10. 7721 Mechanical Tee w/ Pressure Gauge

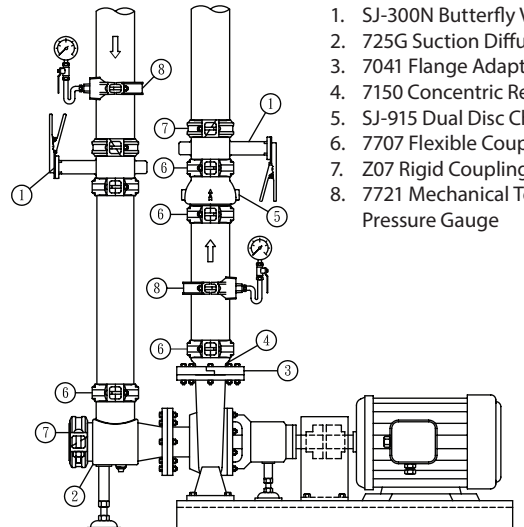

Sample installation with Suction Diffuser.

1. SJ-300N Butterfly Valve
2. 725G Suction Diffuser
3. 7041 Flange Adapter
4. 7150 Concentric Reducer
5. SJ-915 Dual Disc Check Valve
6. 7707 Flexible Coupling
7. Z07 Rigid Coupling
8. 7721 Mechanical Tee w/ Pressure Gauge





The Shurjoint Model SJ-200 Butterfly Valve is a low profile, grooved-end butterfly valve for oil & gas and or mining services. Working pressure is rated up to 232 psi / 1600 kPa and service temperatures up to +180°F/+82°C (Nitrile body liner). The Model SJ-200 features a fully rubber lined body with 316 stainless steel disc. The end-to-end dimensions conform to MSS SP-67. The lever handle is equipped with a tamper resistant locking device.

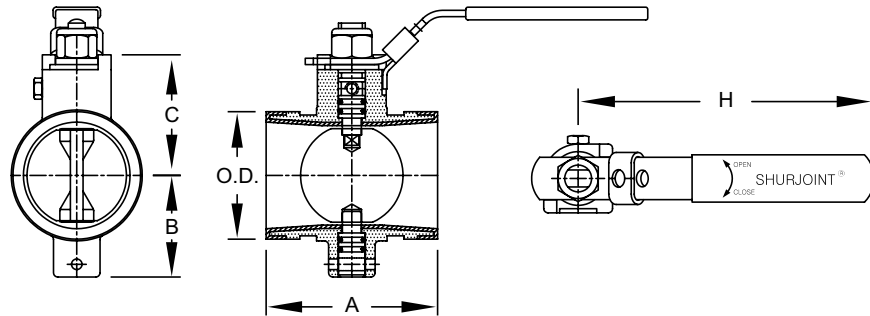

DIMENSIONS

NOMINAL SIZE	PIPE O.D.	MAX. WORKING PRESSURE (CWP)*	DIMENSIONS				WEIGHT
			A	B	C	H	
in	in	PSI	in	in	in	in	lb
mm	mm	Bar	mm	mm	mm	mm	kg
2	2.375	232	3.19	1.89	2.25	5.51	2.0
50	60.3	16	81	48	57	140	0.9
2-1/2	2.875	232	3.82	2.13	2.65	7.48	3.3
65	73.0	16	97	54	67	190	1.5
3	3.500	232	3.82	2.44	2.94	7.48	4.2
80	88.9	16	97	62	75	190	1.9
4	4.500	232	4.57	3.00	3.82	10.79	8.6
100	114.3	16	116	76	97	274	3.9
6	6.625	232	5.83	4.09	4.57	10.79	22.2
150	168.3	16	148	104	116	274	10.1
8	8.625	232	5.25	5.50	6.00	10.79	27.9
200	219.1	16	133	140	152	274	11.3

*Working pressure is based on connection with roll- or cut-grooved standard wall carbon steel pipe.



The Model SJ-300N Butterfly Valve is a grooved-end tight shut-off valve designed, manufactured and tested to MSS SP-67. The valve can be shipped either with a 10-position lever handle with a locking device (SJ-300N-L) or with a worm gear operator (SJ-300N-W). The valve consists of epoxy powder coated ductile iron body and EPDM or Nitrile (NBR) rubber encapsulated dual-seal disc. The Model SJ-300N is rated up to + 200°F (+93°C) for general service use and is UL classified in accordance with NSF/ANSI 61 and NSF/ANSI 372 for potable water service up to temperature +180°F (+82°C).



- End-to-End Dimensions: MSS SP-67 Table 4
- End Connections: Grooved ends to ANSI/AWWA C-606
- Pressure Rating: 300 psi / 2.1 MPa (non-shock cold water)
- Max. Service Temperature: 180°F / 82°C (EPDM) – Potable water service
200°F / 93°C (EPDM)* – General service

DIMENSIONS

SJ-300N-L

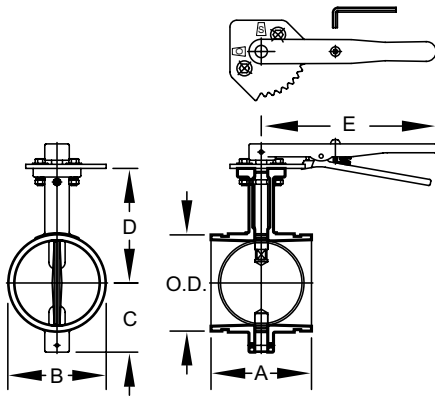

NOMINAL SIZE	PIPE O.D.	MAX. WORKING PRESSURE (CWP)*	DIMENSIONS					OPERATING TORQUE	WEIGHT [^]
			A	B	C	D	E		
in	in	PSI	in	in	in	in	in	lb-in	lb
mm	mm	Bar	mm	mm	mm	mm	mm	Nm	kg
2	2.375	300	3.19	2.52	2.48	4.17	7.56	80	6.8
50	60.3	20	81	64	63	106	192	9	3.1
2-1/2	2.875	300	3.82	3.11	2.68	4.37	7.56	120	8.2
65	73.0	20	97	79	68	111	192	14	3.7
3	3.500	300	3.82	3.62	2.99	4.96	7.56	160	9.0
80	88.9	20	97	92	76	126	192	18	4.1
4	4.500	300	4.57	4.65	3.50	5.32	10.24	450	11.4
100	114.3	20	116	118	89	135	260	51	5.2
5	5.563	300	5.83	5.71	4.02	6.61	10.24	700	16.9
125	141.3	20	148	145	102	168	260	79	7.7
6	6.625	300	5.83	6.77	4.49	7.24	10.24	900	20.2
150	168.3	20	148	172	114	184	260	102	9.2
8	8.625	300	5.24	8.74	5.51	8.19	10.24	1200	26.8
200	219.1	20	133	222	140	208	260	136	12.2
10	10.750	300	6.25	10.86	6.69	9.25	14.02	1800	48.4
250	273.0	20	159	276	170	235	356	204	22.0
12	12.750	300	6.53	12.87	8.07	10.24	14.02	2500	73.7
300	323.9	20	165	327	205	260	356	282	33.5

* Working pressure is based on connection with roll- or cut-grooved standard wall carbon steel pipe.

[^] The weight includes the lever handle.

Notes: The torque values are based on liquid applications. For dry or non-lubricating applications add a 25% service factor to the above values.

DIMENSIONS

10 POSITION INDICATOR AND LEVER

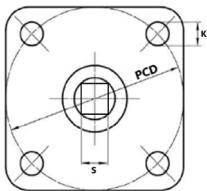

NOMINAL SIZE	PCD (DIA.)	K (DIA.)	S (SQUARE)	L
in	in	in	in	in
mm	mm	mm	mm	mm
2	2.75	0.354	0.39	7.56
50	70	9	10	192
2-1/2	2.75	0.354	0.39	7.56
65	70	9	10	192
3	2.75	0.354	0.39	7.56
80	70	9	10	192
4	2.75	0.354	0.47	10.24
100	70	9	12	260
5	2.75	0.354	0.47	10.24
125	70	9	12	260

NOMINAL SIZE	PCD (DIA.)	K (DIA.)	S (SQUARE)	L
in	in	in	in	in
mm	mm	mm	mm	mm
6	2.75	0.354	0.63	10.24
150	70	9	16	260
8	2.75	0.354	0.63	10.24
200	70	9	16	260
10	4	0.433	0.94	14.02
250	102	11	24	356
12	4	0.433	0.94	14.02
300	102	11	24	356

The Model SJ-300N can be equipped with a worm gear operator. The ISO 5211 mounting pad allows for the mounting of power actuators.



DIMENSIONS SJ-300N-W

NOMINAL SIZE	PIPE O.D.	MAX. WORKING PRESSURE (CWP)*	DIMENSIONS						WEIGHT ^Δ
			A	B	C	D	E	F	
in	in	PSI	in	in	in	in	in	in	lb
mm	mm	Bar	mm	mm	mm	mm	mm	mm	kg
2	2.375	300	3.19	2.52	2.48	4.17	6.00	6.00	13.6
50	60.3	20	81	64	63	106	152	152	6.2
2-1/2	2.875	300	3.82	3.11	2.68	4.37	6.00	6.00	14.3
65	73.0	20	97	79	68	111	152	152	6.5
3	3.500	300	3.82	3.62	2.99	4.96	6.00	6.00	16.0
80	88.9	20	97	92	76	126	152	152	7.3
4	4.500	300	4.57	4.65	3.50	5.32	6.00	6.00	19.1
100	114.3	20	116	118	89	135	152	152	8.7
5	5.563	300	5.83	5.71	4.02	6.61	6.00	6.00	21.8
125	141.3	20	148	145	102	168	152	152	9.9
6	6.625	300	5.83	6.77	4.49	7.24	6.00	6.00	25.3
150	168.3	20	148	172	114	184	152	152	11.5
8	8.625	300	5.24	8.74	5.51	8.19	6.00	6.00	32.0
200	219.1	20	133	222	140	208	152	152	14.5
10	10.750	300	6.25	10.86	6.69	9.25	8.00	8.00	59.4
250	273.0	20	159	276	170	235	203	203	27.0
12	12.750	300	6.53	12.87	8.07	10.24	8.00	8.00	73.7
300	323.9	20	165	327	205	260	203	203	33.5
14	14.000	300	7.00	14.37	8.82	10.86	9.50	12.00	130.0
350	355.6	20	178	365	224	276	242	306	59.0
16	16.000	300	7.00	16.38	9.76	11.89	9.50	12.00	147.4
400	406.4	20	178	416	248	302	242	306	67.0
18	18.000	300	8.00	18.50	11.14	13.78	9.50	12.00	189.2
450	457.2	20	203	470	283	350	242	306	86.0
20	20.000	300	8.50	20.75	12.36	15.08	11.50	16.00	292.6
500	508.0	20	216	527	314	383	290	412	133.0
22	22.000	300	9.25	22.75	13.48	16.81	11.50	16.00	324.1
550	559.0	20	235	578	343	427	290	412	147.0
24	24.000	300	10.00	24.76	14.49	17.83	11.50	16.00	352.0
600	609.6	20	254	629	368	453	290	412	160.0

* Working pressure is based on connection with roll- or cut-grooved standard wall carbon steel pipe.
^Δ The weight includes the worm gear operator.

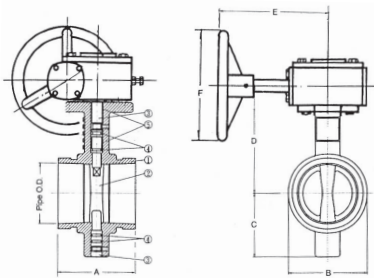

2" - 12"

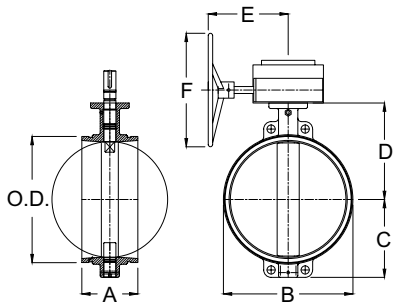

14" - 24"

DIMENSIONS WORM GEAR OPERATOR

NOMINAL SIZE	E	F (DIA.)	PCD (DIA.)	K	S (SQUARE □ OR ROUND ○)		WT.
					in	lb	
in	in	in	in	mm	in	lb	
mm	mm	mm	mm	mm	mm	kg	
2	6	6	2.75	M8	□ 0.39	9	
50	152	152	70		10	4.1	
2-1/2	6	6	2.75	M8	□ 0.39	9	
65	152	152	70		10	4.1	
3	6	6	2.75	M8	□ 0.39	9	
80	152	152	70		10	4.1	
4	6	6	2.75	M8	□ 0.47	9	
100	152	152	70		12	4.1	
5	6	6	2.75	M8	□ 0.47	9	
125	152	152	70		12	4.1	
6	6	6	2.75	M8	□ 0.63	9	
150	152	152	70		16	4.1	
8	6	6	2.75	M8	□ 0.63	9	
200	152	152	70		16	4.1	
10	8	8	4.02	M10	□ 0.94	12.3	
250	203	203	102		24	5.6	
12	8	8	4.02	M10	□ 0.94	12.3	
300	203	203	102		24	5.6	
14	9.53	12	4.9	M12	□ 0.94	32.8	
350	242	306	125		24	14.9	
16	9.53	12	4.9	M16	○ 1.44	32.8	
400	242	306	125		36.6	14.9	
18	9.53	12	5.5	M16	○ 1.625	32.8	
450	242	306	140		41.28	14.9	
20	11.4	16.2	6.5	M20	○ 2.04	67.1	
500	290	412	165		51.9	30.5	
22	11.4	16.2	6.5	M20	○ 2.04	67.1	
550	290	412	165		51.9	30.5	
24	11.4	16.2	6.5	M20	○ 2.04	67.1	
600	290	412	165		51.9	30.5	



The Model SJ-500L is a ductile iron, grooved-end, two-piece, regular port ball valve designed and tested in conformance with MSS SP-110 and SP- 72. The lever handle is equipped with tamper resistant locking holes. The SJ-500L is comprised of a ductile iron body and end cap, virgin TFE seats and stainless steel trim. Chrome-plated carbon steel trim is also available upon request.

DIMENSIONS

NOMINAL SIZE	PIPE O.D.	MAX. WORKING PRESSURE (CWP)*	OPERATING TORQUE †	DIMENSIONS							WEIGHT
				L	H	W	D	A	B	C	
in	in	PSI	lb-in	in	in	in	in	in	in	in	lb
mm	mm	Bar	Nm	mm	mm	mm	mm	mm	mm	mm	kg
1-1/2	1.9	1000	62	5.12	3.39	7	1.25	0.625	0.312	1.775	3.9
40	48.3	69	7	130	86	178	32	15.9	7.9	45.1	1.8
2	2.375	1000	150	5.5	3.75	7	1.5	0.625	0.312	2.25	6.4
50	60.3	69	17	140	95	178	38	15.9	7.9	57.2	2.9
2-1/2	2.875	1000	186	6.25	5.2	10.43	2	0.625	0.312	2.72	9.7
65	73	69	21	159	132	265	50	15.9	7.9	69.1	4.4
3	3.5	1000	248	6.56	5.63	10.43	2.5	0.625	0.312	3.344	17.2
80	88.9	69	28	167	143	265	63	15.9	7.9	84.9	7.8
4	4.5	800	398	9.45	5.31	14.37	3.5	0.625	0.312	4.334	34.5
100	114.3	56	45	240	135	365	90	15.9	7.9	110	15.7
6	6.625	800	531	10.15	8.7	23.6	4.92	0.625	0.374	6.453	90.2
150	168.3	56	60	258	221	600	125	15.9	9.5	163.9	41.1

* Working pressure is based on connection with roll- or cut-grooved standard wall carbon steel pipe.

† For the first opening or closing of the valve when the valve is not continuously operated, an additional torque of 2.0 – 2.5 times the listed operating torque is normally required.

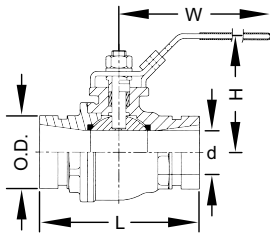

1-1/2" - 3"

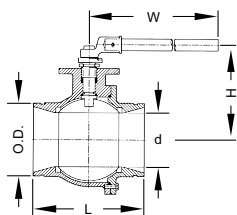

4" - 6"

SJ-500W BALL VALVE W/ GEAR OPERATOR

The Model SJ-500W can be equipped with a worm gear operator. The standard gear operator is supplied with a bracket and extension sleeve. The ISO 5211 mounting pad allows for the mounting of power actuators.

DIMENSIONS

NOMINAL SIZE	DIMENSIONS					WEIGHT
	W	K	G	PCD	D	
in	in	in	in	in	in	lb
mm	mm	mm	mm	mm	mm	kg
1-1/2	5.98	5.98	5.35	1.65	0.31	11
40	152	152	136	42	8	5
2	5.98	5.98	5.35	1.97	0.31	11
50	152	152	136	50	8	5
2-1/2	5.98	5.98	5.35	1.97	0.31	11
65	152	152	136	50	8	5
3	8	5.98	5.55	2.75	0.4	15
80	203	152	141	70	10	7
4	8	5.98	5.55	2.75	0.4	15
100	203	152	141	70	10	7
6	9.53	12	6.55	5.5	0.55	44
150	242	305	166	140	14	20

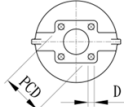
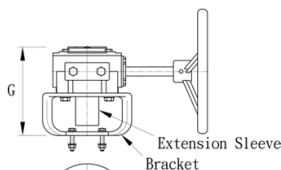
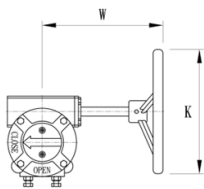



The Shurjoint Model SJ-900 Swing Check Valve is a grooved-end check valve featuring a spring-loaded wide-open clapper and a non-stick leak tight EPDM or Nitrile rubber seal. With a rated working pressure of 300 psi (20 bar), the valve can be installed in the horizontal or vertical position (upward flow only). Valves are tested to API 598.

Important Note: The placement of check valves too close to sources of unstable flows may damage the system and reduce valve life. Sound piping practices dictate check valves should always be installed a minimum of five (5) times the pipe diameter downstream from pumps, reducers, elbows and the like. Distances between three (3) and five (5) times are allowable when flow velocity does not exceed eight (8) feet per second (2.4 mps). Distances less than three diameters are not recommended and will void any warranty.

DIMENSIONS

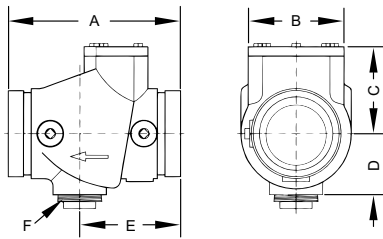

NOMINAL SIZE	PIPE O.D.	MAX. WORKING PRESSURE (CWP)*	DIMENSIONS						WEIGHT
			A	B	C	D	E	F	
in	in	PSI	in	in	in	in	in	in	lb
mm	mm	Bar	mm	mm	mm	mm	mm	mm	kg
2-1/2	2.875	300	7.48	4.50	3.75	2.50	4.00	1-1/4 NPT	11.0
65	73.0	20	190	114	95	64	102	1-1/4 NPT	5.0
3	3.500	300	7.00	4.50	3.75	2.50	4.00	1-1/4 NPT	10.8
80	88.9	20	178	114	95	64	102	1-1/4 NPT	4.9
4	4.500	300	8.50	5.75	4.60	3.15	5.00	2 NPT	18.3
100	114.3	20	216	146	117	80	127	2 NPT	8.3
5	5.563	300	13.00	8.58	7.00	4.50	7.64	2 NPT	51.7
125	141.3	20	330	218	178	114	194	2 NPT	23.5
6	6.625	300	12.00	8.25	7.05	4.50	7.00	2 NPT	51.7
150	168.3	20	305	210	178	114	178	2 NPT	23.5
8	8.625	300	14.37	10.47	8.54	5.50	10.00	2 NPT	99.7
200	219.1	20	365	266	217	140	254	2 NPT	45.3
10	10.750	300	20.00	14.37	10.75	7.25	10.00	2 NPT	217.8
250	273.0	20	508	365	273	184	254	2 NPT	99.0
12	12.750	300	24.00	15.51	12.87	8.54	12.00	2 NPT	342.3
300	323.9	20	610	394	327	217	305	2 NPT	155.6

*Working pressure is based on connection with roll- or cut-grooved standard wall carbon steel pipe.



2-1/2" - 12"

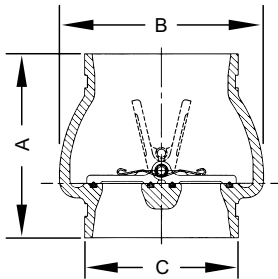

The Shurjoint Model SJ-915 is a grooved-end dual-plate (or double-door) check valve designed to provide positive and silent protection against backflow in piping systems. The valve features a ductile iron body with an EPDM or Nitrile resilient seat molded to body and type 304 stainless steel discs loaded with type 313 stainless steel springs. Groove dimensions comply with ANSI/AWWA C606.

FEATURES

- Lightweight (up to 90% lighter than conventional swing check valves)
- Easy to install with a couple of grooved couplings, more economical than wafer or lugged valves
- The dual disc design produces less water hammer than single disc valves
- The spring-loaded disc design provides for positive closing
- The resilient seat reduces noise when slamming
- Good for horizontal or vertical installations (*see notes)
 1. For horizontal use, the valve shall be installed perpendicular to the flow, or with disc pin in the vertical position.
 2. For vertical use, the valve shall be installed with flow up.
 3. The valve shall be installed with a distance of five (5) pipe diameters, min., downstream from pump discharge, reducers or elbows.

DIMENSIONS

NOMINAL SIZE	PIPE O.D.	WORKING PRESSURE (CWP)*	DIMENSIONS †			WEIGHT
			A	B	C	
in	in	PSI	in	in	in	lb
mm	mm	Bar	mm	mm	mm	kg
2-1/2	2.875	300	4.92	4.33	2.87	5.0
65	73.0	20	125	110	73	2.3
3	3.500	300	5.31	4.92	3.50	5.5
80	88.9	20	135	125	89	2.5
4	4.500	300	5.39	5.98	4.50	8.4
100	114.3	20	137	152	114	3.8
6	6.625	300	6.00	8.03	6.62	11.7
150	168.3	20	152	204	168	7.6
8	8.625	300	6.73	10.08	8.62	27.3
200	219.1	20	171	256	219	12.4
10	10.750	300	7.80	12.09	10.75	45.5
250	273.0	20	198	307	273	20.7
12	12.750	300	8.19	14.25	12.75	62.2
300	323.9	20	208	362	324	28.3

*Working pressure is based on connection with roll- or cut-grooved standard wall carbon steel pipe.

† Dimensions are subject to change.



14" - 24"

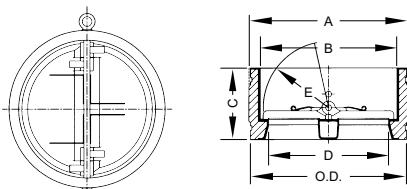

The Shurjoint model SJ-915 is a grooved-end dual disc check valve for pipelines conveying water and other fluids with the rated working pressure to 300 psi (20 Bar), available in sizes 14" to 24" / 350 mm to 600 mm. The valve features a fully lined rubber body, spring-loaded 304 stainless steel disc and shafts. The valve can be installed in a horizontal or vertical position (upward flow only). Face to face dimensions conform to API 594 Class 150 and grooved ends to ANSI/AWWA C606.

FEATURES

- Lightweight (up to 90% lighter than conventional swing check valves)
- Easy to install with a couple of grooved couplings, more economical than wafer or lugged valves
- The dual disc design produces less water hammer than single disc valves
- The spring-loaded disc design provides for positive closing
- The fully lined rubber body and soft seat reduce noise and maintenance

TESTING

- Seat Test: (Hydrostatic) 275 psi / 1.90 MPa
- Shell Test: (Hydrostatic) 400 psi / 2.75 MPa

DIMENSIONS

NOMINAL SIZE	PIPE O.D.	MAX. WORKING PRESSURE (CWP)*	DIMENSIONS					WEIGHT
			A	B	C	D	E	
in	in	PSI	in	in	in	in	in	lb
mm	mm	Bar	mm	mm	mm	mm	mm	kg
14	14.000	300	14.49	12.96	7.13	11.14	6.06	101
350	355.6	20	368	329	181	283	154	46
16	16.000	300	16.14	14.13	7.24	12.20	6.81	119
400	406.4	20	410	359	184	310	173	54
18	18.000	300	18.15	16.42	7.83	14.33	8.00	169
450	457.2	20	461	417	199	364	203	77
20	20.000	300	20.04	18.11	8.46	16.06	8.80	211
500	508.0	20	509	460	215	408	226	96
24	24.000	300	24.00	22.13	9.65	18.00	9.80	288
600	609.6	20	610	562	245	457	249	131

*Working pressure is based on connection with roll- or cut-grooved standard wall carbon steel pipe.



The Shurjoint Model SJ-930 horizontal swing check valves are supplied with grooved ends and are designed for general services including mining and oilfield applications. The SJ-930 features a bonnet cap which is drilled, tapped (1/2" NPT), and plugged and secured using a Shurjoint XH-70EP* coupling. The 316 stainless steel clapper is supplied standard encapsulated with Nitrile. As an option we offer Fluoro-elastomer or Teflon encapsulations to meet your service requirements.
 * SJ-930 in size 4" is equipped with Shurjoint #7771 5" Rigid Coupling.

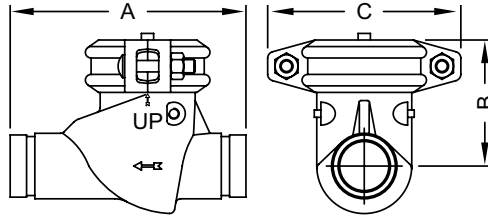

DIMENSIONS

NOMINAL SIZE	PIPE O.D.	MAX. WORKING PRESSURE (CWP)*	DIMENSIONS			WEIGHT
			A	B	C	
in	in	PSI	in	in	in	lb
mm	mm	Bar	mm	mm	mm	kg
2	2.375	1000	9.00	4.88	5.90	14.5
50	60.3	69	229	124	150	6.6
2-1/2	2.875	1000	9.25	5.50	7.00	22.9
65	73.0	69	235	140	178	10.4
3	3.500	600	10.75	5.75	7.40	26.8
80	88.9	42	273	146	188	12.2
4	4.500	600	12.00	7.63	8.74	38.1
100	114.3	42	305	194	222	17.3
6	6.625	600	16.25	9.15	14.32	103.5
100	168.1	42	413	232.5	363.8	46.9

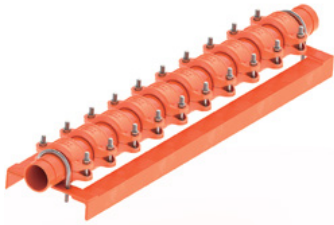
* Pressure ratings are based on cut-grooved sch. 40 or thicker pipe connected with Shurjoint XH-70EP extra heavy rigid couplings.

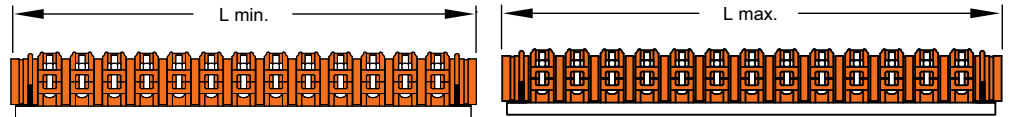

The Model 651 Expansion Joint is a combination of couplings and specially machined pipe nipples that are joined in a series to accommodate the expansion and contraction of a piping system. The nipples are precisely grooved to provide full linear allowance at each joint. Standard units are comprised of either Model 7705 or Model 7707 flexible couplings and cut-grooved Sch. 40 pipe nipples. The end pieces are supplied grooved-ends to ANSI/AWWA C606 requirements for use with grooved mechanical couplings. Customized units are also available. The components are epoxy coated (RAL3000 red) for ease of use and longer life. 651 Expansion Joints are for horizontal use only.



DIMENSIONS

NOMINAL SIZE	PIPE O.D.	COUPLINGS (STANDARD UNITS)†	MAX. WORKING PRESSURE (CWP)*	MAX. MOVEMENT	L - (REF.) §		WEIGHT
					MIN. (COMPRESSED)	MAX. (EXPANDED)	
in	in	Model No.	PSI	in	in	in	lb
mm	mm	No.	Bar	mm	mm	mm	kg
1-1/2	1.900	7705 or 7707	350	2.91	28.25	31.18	24.2
40	48.3	10	24	74	718	792	11.0
2	2.375	7705 or 7707	350	3.11	28.25	31.38	27.0
50	60.3	10	24	79	718	797	12.2
2-1/2	2.875	7705 or 7707	350	3.11	28.25	31.38	36.0
65	73.0	10	24	79	718	797	16.3
3	3.500	7705 or 7707	350	3.11	28.25	31.38	46.0
80	88.9	10	24	79	718	797	20.9
4	4.500	7705 or 7707	350	2.09	26.50	28.58	36.5
100	114.3	7	24	53	673	726	16.6
6	6.625	7705 or 7707	350	2.09	26.26	28.35	91.1
150	168.3	7	24	53	667	720	41.4
8	8.625	7705 or 7707	350	1.93	28.50	30.43	159.7
200	219.1	7	24	49	724	773	72.6
10	10.750	7705 or 7707	350	3.46	33.03	36.46	257.2
250	273.0	7	24	88	839	926	116.9
12	12.750	7705 or 7707	350	3.19	33.31	36.46	373.0
300	323.9	7	24	81	846	926	169.3

†For Performance Data refer to C-01 for Model 7705 and C-02 for Model 7707.

Note: Available with greater or less movement by adding or eliminating couplings and nipple units.

L - (ref.) § Min and max length given are based on number of couplings in a standard unit. Lengths will vary with tolerance and number of couplings needed for your system needs.

*Working pressure is based on connection with roll- or cut-grooved standard wall carbon steel pipe.

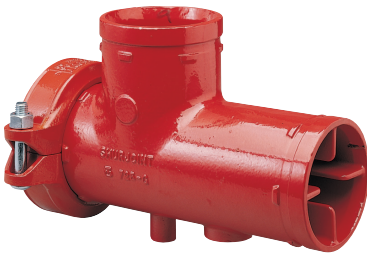

The Model 725G Suction Diffuser features a space saving design, ductile iron body and integral vanes that effectively reduce turbulence and provide optimum flow conditions at the inlet side of the pump.

The suction diffuser's inlet is supplied with a grooved end to AWWA C606-04. The 725G can be connected directly to grooved end pump or to a flanged end pump if used in combination with a Model 7041 flange or a Model 7180 universal flange adapter.

If a distance adjustment is required a nipple adapter can be used between the pump and the suction diffuser. The 725G also allows for a reduction on the outlet when used in combination with a Model 7150 concentric reducer and a Model 7041 flange.

The Model 725G is supplied with a 304 stainless steel running strainer and a disposable fine mesh screen to protect the pump during start-up operation.

FOR FLANGED CONNECTION

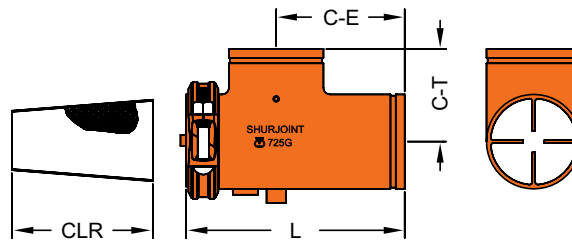
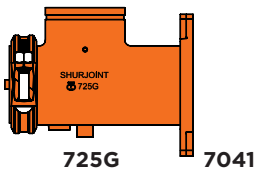

WITH UNIVERSAL FLANGE

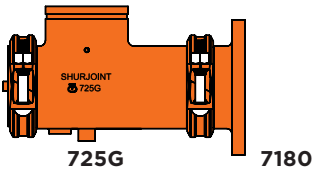

EXTENSION

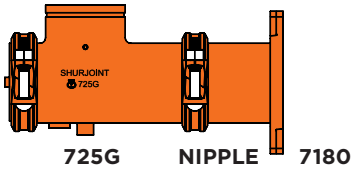

REDUCTION

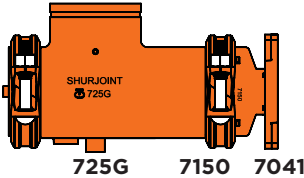

DIMENSIONS

NOMINAL SIZE		MAX. WORKING PRESSURE (CWP)*	DIMENSIONS				DRAIN	WEIGHT
SYSTEM SIDE	PUMP SIDE		L	C-E	CLR	C-T		
in	in	PSI	in	in	in	in	lb	
mm	mm	Bar	mm	mm	mm	mm	kg	
2	2	300	8.82	5.00	5.79	3.75	1/2	7.9
50	50	20	224	127	147	95	1/2	3.6
2-1/2	2-1/2	300	8.82	5.00	5.79	3.75	1/2	8.8
65	65	20	224	127	147	95	1	4.0
3	3	300	10.43	6.30	6.93	5.51	1	13.0
80	80	20	265	160	176	140	1	5.9
4	4	300	12.28	7.36	8.58	5.00	1	20.9
100	100	20	312	187	218	127	1	9.4
5	5	300	13.86	10.24	9.76	9.02	1	38.9
125	125	20	352	260	248	229	1	17.7
6	6	300	15.16	9.02	10.43	6.50	1	43.3
150	150	20	385	229	265	165	1	19.7
8	8	300	18.27	10.24	12.60	9.02	1-1/4	75.5
200	200	20	464	260	320	229	1-1/4	34.3
10	10	300	22.11	12.40	16.14	9.02	1-1/4	123.2
250	250	20	562	315	410	229	1-1/4	56.0
12	12	300	26.30	15.43	19.29	10.00	1-1/4	168.1
300	300	20	668	392	490	254	1-1/4	76.4

* Working pressure is based on connection with roll- or cut-grooved standard wall carbon steel pipe.



The Model 726 Grooved-end Y-Strainers are designed to strain debris and foreign matter from piping systems and thus provide inexpensive protection for costly pumps, meters and other components. The 726 Y-Strainer can be installed quickly and easily with two mechanical couplings and the straight flow through design provides for lower pressure drop. This strainer features a stainless steel screen that is secured with an end cap and mechanical coupling. Cleaning and maintenance of the screen can be accomplished easily by removing the coupling. The Model 726 Y-Strainer is suitable for vertical or horizontal installations. The coupling can be supplied with "E" EPDM or "T" Nitrile gaskets.

Standard Screen: 1/16" (1.6 mm) perforated for 2"-3" sizes and 1/8" (3.2 mm) perforated for 4" ~ 16". Other customized screen perforations are available on request.

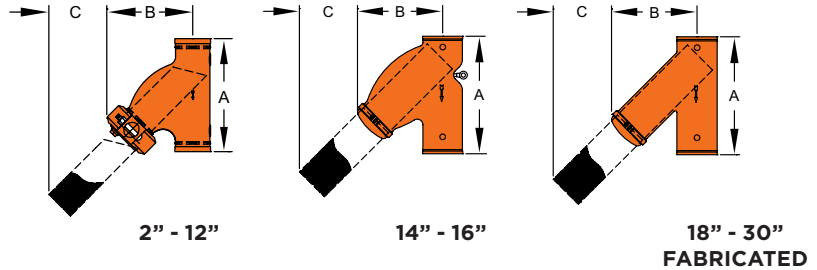

DIMENSIONS

NOMINAL SIZE	PIPE O.D.	MAX. WORKING PRESSURE (CWP)**	DIMENSIONS			DRAIN PLUG SIZE	WEIGHT
			A	B	C		
in	in	PSI	in	in	in	in	lb
mm	mm	Bar	mm	mm	mm	mm	kg
2	2.375	300	9.75	7.13	4.56	1/2	9.3
50	60.3	20	248	181	116	15	4.2
2-1/2	2.875	300	10.75	7.83	4.80	1/2	13.2
65	73.0	20	273	199	122	15	6.0
3	3.500	300	11.75	8.70	5.08	1	16.2
80	88.9	20	299	221	129	25	7.6
4	4.500	300	14.25	10.59	6.61	1	26.4
100	114.3	20	362	269	168	25	12.0
5	5.563	300	16.50	13.00	10.16	1	48.4
125	141.3	20	419	330	258	25	22.0
6	6.625	300	18.50	14.05	8.62	1	65.4
150	168.3	20	470	357	219	25	29.7
8	8.625	232	24.00	17.87	11.18	1-1/2	121.0
200	219.1	16	610	454	284	40	55.0
10	10.750	175	27.00	20.55	12.60	1-1/2	182.6
250	273.0	12	686	522	320	40	83.0
12	12.750	175	30.00	24.00	14.40	1-1/2	277.2
300	323.9	12	762	609	366	40	126.0
14	14.000	175	40.00	29.92	18.90	1-1/4	418.0
350	355.6	12	1016	760	480	32	190.0
16	16.000	175	42.00	30.60	19.00	1-1/4	495.0
400	406.4	12	1067	777	483	32	225.0
18*	18.000	175	48.50	33.50	28.00	2	825.0
450	457.2	12	1232	851	711	50	375.0
20*	20.000	175	53.75	39.00	32.00	2	1056.0
500	508.0	12	1365	991	813	50	480.0
22*	22.000	175	60.00	40.50	33.00	2	1474.0
550	559.0	12	1527	1029	838	50	670.0
24*	24.000	175	64.00	42.00	34.00	2	1683.0
600	609.6	12	1626	1067	864	50	765.0
26*	26.000	175	68.00	47.00	38.00	2	2244.0
650	660.4	12	1727	1194	965	50	1020.0
28*	28.000	175	72.00	51.50	41.00	2	3014.0
700	711.2	12	1829	1308	1041	50	1370.0
30*	30.000	175	75.00	56.00	44.50	2	3487.0
750	762.0	12	1905	1422	1130	50	1585.0

*Working pressure is based on connection with roll- or cut-grooved standard wall carbon steel pipe.



The Shurjoint Model 728 grooved-end T-strainers are used to remove foreign matter from pipe lines and provide inexpensive protections to pumps, meters, valves, etc. The Model 728 strainers are designed for applications where easy maintenance and large capacity of straining are needed including drinking water, cooling water, irrigation, sea water, etc. The strainer installs with two Shurjoint couplings, and is rated up to 750 psi (52 Bar) depending upon the installed coupling's pressure rating and size. The strainer is made of 316 stainless steel mesh fringed with a durable stainless steel frame. The standard screen is mesh 12 for 2-1/2" to 3" sizes and mesh 6 for 4" to 14". The coupling can be supplied with "E" EPDM or "T" Nitrile gaskets.

The strainer shall be cleaned periodically or before the differential pressure reaches 10 psi.

FEATURES

- The streamline design provides lower pressure drop
- Easy installation with two mechanical couplings
- Easy removal and reinstallation of the screen by removing the two bolts and nuts of the coupling and end-cap (three bolts and nuts for 14").
- Good for horizontal or vertical installations.
- Easy access to the screen from above or side-ways
- More space-saving than the Y type strainers

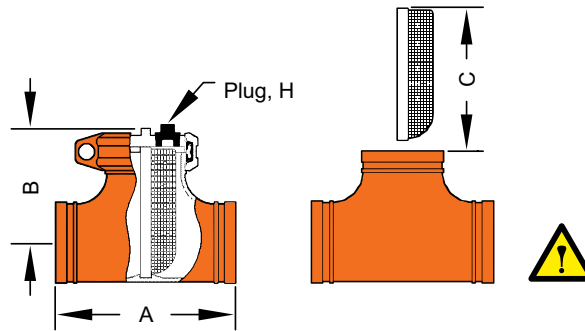

DIMENSIONS

NOMINAL SIZE	PIPE O.D.	MAX. WORKING PRESSURE (CWP)*	DIMENSIONS			H (DRAIN PLUG)	WEIGHT
			A	B	C		
in	in	PSI	in	in	in	in	lb
mm	mm	Bar	mm	mm	mm	mm	kg
2	2.375	750	6.54	4.72	4.92	½	6.6
50	60.3	52	166	120	125	15	3.0
2-1/2	2.875	750	7.50	5.19	5.59	½	8.8
65	73.0	52	191	132	142	15	4.0
3	3.500	750	8.50	5.74	6.45	½	13.2
80	88.9	52	216	146	164	15	6.0
4	4.500	750	10.00	6.49	7.48	1	17.7
100	114.3	52	254	165	190	25	8.0
5**	5.563	750	11.00	7.48	8.58	1	28.6
125	141.3	52	279	190	218	25	13.0
6	6.625	700	13.00	8.34	10.23	1	44.0
150	168.3	48	330	212	260	25	20.0
8	8.625	600	15.50	9.96	12.60	1-1/2	77.0
200	219.1	42	394	253	320	40	35.0
10	10.750	500	18.00	11.18	14.96	1-1/2	114.6
250	273.0	35	457	284	380	40	52.0
12	12.750	400	20.00	12.16	16.92	1-1/2	160.3
300	323.9	28	508	309	430	40	72.7
14	14.000	250	22.00	17.75	21.25	1-1/2	186.3
350	355.6	17	559	451	540	40	84.5

*Working pressure is based on connection with roll- or cut-grooved standard wall carbon steel pipe. Working pressure is maximum based on Shurjoint Model Z07 access coupling and will be governed by couplings used for installation and related system components. Maximum differential pressure from inlet to outlet must not exceed 10 psi (0.69 Bar). Working pressure is dependent upon the Shurjoint coupling used to join Model 728 to the piping system.



The Shurjoint Model BH-22C swing check valve is designed for IPS grooved inlet and outlet connections, featuring a brass body with spring-loaded clapper with rubber seat, rated 250 psi (17 bar) working water pressure and suitable for installation in the horizontal or vertical position (upward flow only). The valve body, end piece and clapper are made of brass castings per ASTM A-584 copper alloy C85700. For installation in Shurjoint's copper system, use Model C307 transition coupling.

Important Note: The placement of check valves too close to sources of unstable flows may damage the system and reduce valve life. Sound piping practices dictate check valves should always be installed a minimum of five (5) times the pipe diameter downstream from pumps, reducers, elbows and the like.

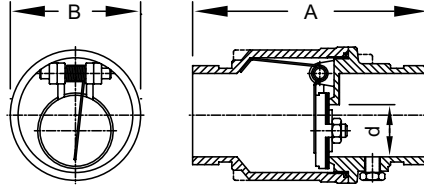
DIMENSIONS

NOMINAL SIZE	PIPE O.D.	MAX. WORKING PRESSURE (CWP) *	DIMENSIONS			WEIGHT
			A	B	D	
in	in	PSI	in	in	in	lb
mm	mm	Bar	mm	mm	mm	kg
2	2.375	250	5.70	3.25	1.38	3.5
50	60.3	17	145	83	35	1.6
2-1/2	2.875	250	6.50	4.21	1.88	6.8
65	73.0	17	165	107	48	3.1
3	3.500	250	7.64	4.88	2.44	9.9
80	88.9	17	194	124	62	4.5
4	4.500	250	7.95	5.59	3.31	11.9
100	114.3	17	202	142	84	5.4

*Working pressure is based on connection with roll- or cut-grooved standard wall carbon steel pipe.

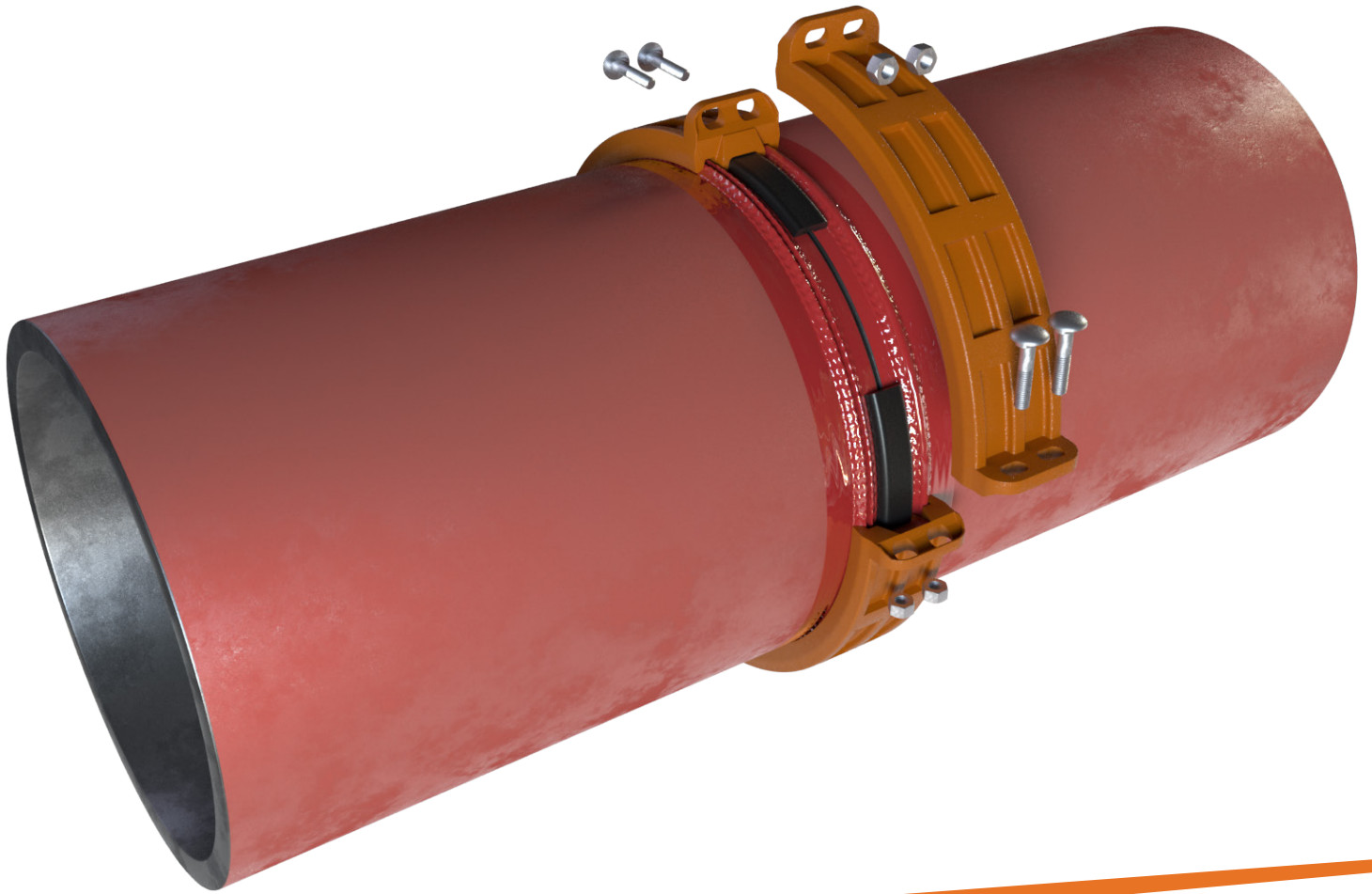

**ring joint &
plain-end couplings**

Shurjoint ring joint, shouldered and plain end couplings are non-grooved mechanical pipe joining components and excellent alternatives where pipe is difficult to groove or when grooving is not the preferred method. The processing of a roll groove on pipe becomes more difficult as the pipe O.D. and or wall thickness increases. Roll grooving pipe larger than 14" (350 mm) requires proper tools and equipment. Pipe having a wall thickness greater than 0.375" (9.5 mm) may not be practical to roll groove.

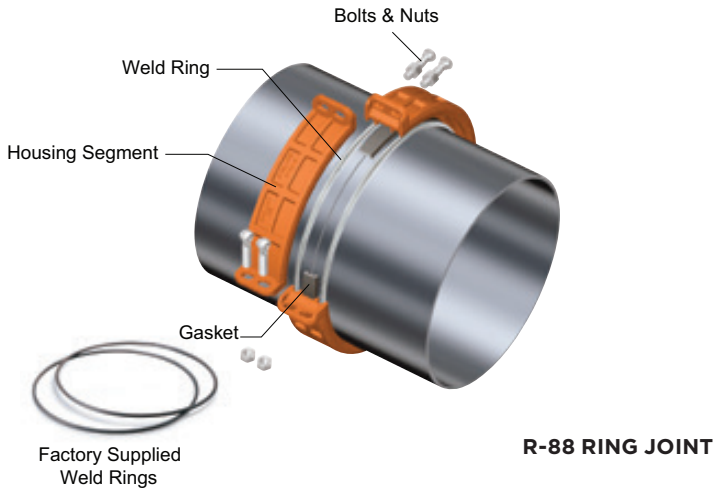

R-88 RING JOINT

RING JOINT COUPLING

The Shurjoint ring joint coupling provides a much more secure joint than a comparable roll-grooved system, simply because the contact area of the rings is much greater than that of the roll-groove profile. In addition, the welded rings are able to withstand 2 - 3 times the shearing forces of roll grooves. High pressure couplings up to 3770 psi (260 Bar) are available.

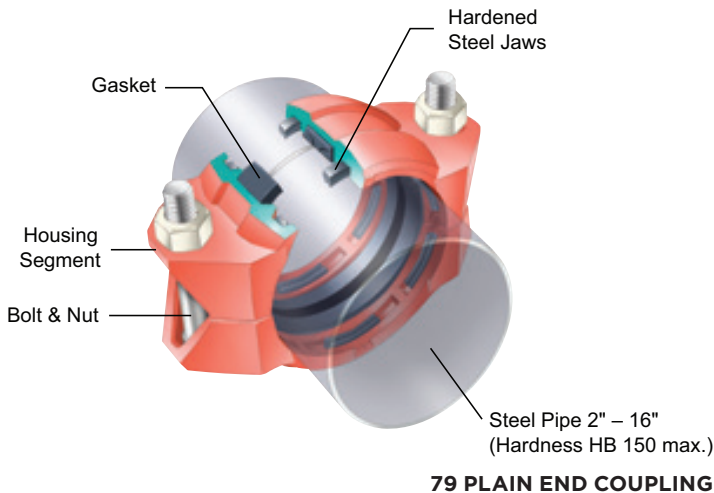

79 PLAIN END COUPLING

PLAIN-END COUPLING

The Shurjoint plain-end coupling securely grips the pipe with its built-in case hardened jaws incorporated within heavy duty housing segments and heavy duty bolts and nuts. The Shurjoint Model 79 Wildcat coupling is designed to join plain-end or beveled-end carbon steel pipe without roll-grooving, welding or threading. The Model 79 plain-end coupling can be used for mining, process piping, manifold piping, and oil field services.

The Shurjoint Model R-88 Ring Joint Coupling is supplied with a pair of factory supplied weld rings. For installation weld a factory-supplied weld ring on each pipe end to be connected, next mount the rubber gasket over the pipe ends, place coupling segments over the gasket and fasten the bolts and nuts.

The Shurjoint R-88 Ring Joint Coupling is considered a shoulder coupling with the factory supplied weld rings serving as the joint shoulders. The R-88's performance standards meet and or exceed the requirements of ASTM F1476 and AWWA C606. The factory supplied weld rings offer a much more economical and convenient alternative to traditional shoulder rings, such as Type A, B, C, D, E, and G rings.

The R-88 Coupling can also be used on stainless steel pipe with optional weld rings available in compatible stainless steel grades. Check with Shurjoint for details and availability.

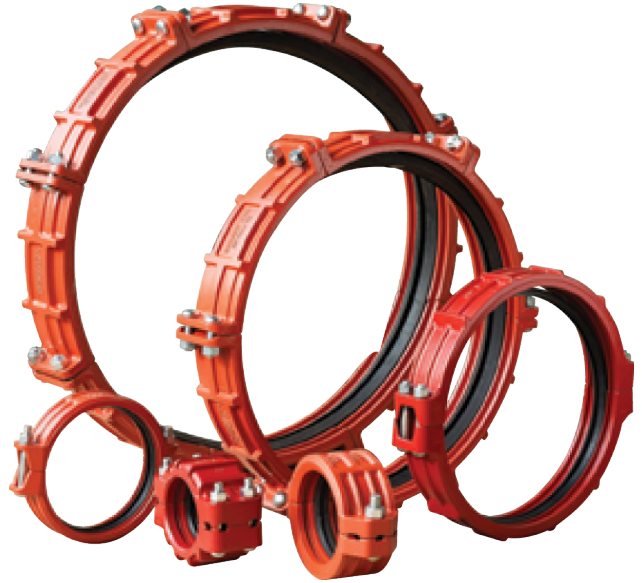

MAX. INTERNAL SERVICE PRESSURE OF CARBON STEEL PIPE, ASTM A53 GR. B

When designing a piping system you must select pipe with the appropriate wall thickness to correspond with the intended working pressure of the system. The table lists design working pressure by the pipe wall schedule, XS, STD and LW, of representative ASTM A53 Gr. B carbon steel pipe calculated in accordance with the formula stipulated in ASME B31.1 Power Piping 104.1.

$$P = \frac{2SE (tm-A)}{Do - 2y (tm - A)}$$

WHERE

- P = Maximum internal service pressure (psi)
- SE = Allowable stress (psi)
(ASTM A53 Gr. B = 15,000 psi)
- tm = Minimum pipe wall thickness (inch)
(87.5% of nominal wall thickness)
- Do = Outside diameter of pipe (inch)
- y = A coefficient
(For ferritic steels 600°F or below = 0.4)
- A = Additional thickness (inch) (A = 0)

NOM. SIZE IN / MM	XS 0.5"	STD 0.375"	LW 0.25" / 0.312"
8 / 200	1586	1006	777
10 / 250	1262	913	621
12 / 300	1058	788	522
14 / 350	962	717	475
16 / 400	839	625	415
18 / 450	744	555	368
20 / 500	668	499	331
24 / 600	555	415	275
26 / 650	512	382	318
28 / 700	475	355	295
30 / 750	443	331	275
32 / 800	415	310	258
36 / 900	368	275	229
38 / 950	349	261	217
40 / 1000	331	248	206
42 / 1050	315	236	187
44 / 1100	301	225	
48 / 1200	275	206	
52 / 1300	254	190	
54 / 1350	245	183	
56 / 1400	236	177	
60 / 1500	220	165	
66 / 1650	200	150	
68 / 1700	194	145	
72 / 1800	183	137	
84 / 2100	157	118	
96 / 2400	137	103	

Except *8": 0.322", ^ 8" ~ 24": 0.25", 26" ~ 42": 0.312"



R-88
8" - 12"

The Shurjoint Model R-88 Ring Joint Coupling is an ideal pipe joining method when pipe is difficult to groove or when grooving is not the preferred joining method. Available in sizes 8" to 96" the R-88 offers ease of use and excellent performance. The Shurjoint Model R-88 Ring Joint Coupling is supplied with a pair of factory supplied weld rings. For installation weld a ring on each pipe end to be connected, next mount the rubber gasket over the pipe ends, place coupling segments over the gasket and fasten the bolts and nuts.

The Shurjoint R-88 Ring Joint Coupling is considered a shouldered coupling with the factory supplied weld rings serving as the joint shoulders. The R-88 performance standards meet, or exceed the 3X pressure safety requirements of ASTM F1476 up to 24. Due to the larger area of the pipes of sizes 26" and larger, the resulting end load force becomes to great for this safety multiple. For this reason the 26" and larger include a 2X safety factor for the listed rated pressures. The factory supplied weld rings offer a much more economical and installation friendly alternative to that of traditional shoulder rings, including Type A, B, C, D, E, and G rings. The R-88 coupling can also be used on stainless steel pipe with optional weld rings available in compatible stainless steel grades. Check with Shurjoint for details and availability.

Typical applications include: • Water & Waste Water Treatment Plants • Mining & Tunnel Boring • Pulp & Paper • Hydroelectric Plants • Co-Gen Electric Plants • Food & Beverage • Compressed Air • HVAC

 Ensure coupling bolt pads make metal-to-metal contact.

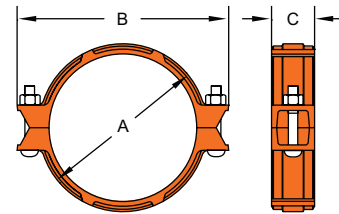
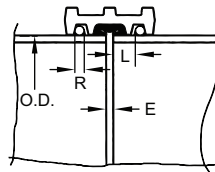
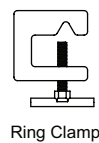

8" - 12"

DIMENSIONS

R88 (8"-12")

NOMINAL SIZE	PIPE O.D.	RINGS BOTH SIDES FULLY WELDED*		AXIAL DISPLACEMENT† E	ANGULAR MOVEMENT / DEFLECTION†		DIMENSIONS			BOLTS		SEALING SURFACE L	RING SIZE R	*NO. OF WELD CLAMPS‡	WEIGHT
		MAX. WORKING PRESSURE (CWP)#	MAX. END LOAD (CWP)#		PER CPLG	PER PIPE	A	B	C	NO.	SIZE				
in mm	in mm	PSI Bar	lb kN	in mm	Deg.(°)	in / ft mm / m	in mm	in mm	in mm		in mm	in mm	in mm		lb kg
8	8.625	400	23350	0-0.340	2.14	0.45	10.08	13.00	3.11	2	3/4 x 4-3/4	0.91	1/4	3	16.8
200	219.1	28	105.51	0-8.7		37	256	330	79		M20x120	23	6.0		7.6
10	10.750	400	36280	0-0.340	1.95	0.41	12.29	15.20	3.25	2	3/4 x 4-3/4	0.91	1/4	3	22.2
250	273.0	28	163.81	0-8.7		34	312	386	83		M20 x 120	23	6.0		10.1
12	12.750	400	51040	0-0.190	0.82	0.17	14.72	17.90	3.39	2	7/8 x 6-1/2	1.02	5/16	3	30.8
300	323.9	28	230.59	0-4.8		14	374	455	86		---	26	8.0		14.0

Note: Dimensions are subject to change without notice. Other sizes are available on request

#Working Pressure and End Load are the total from all internal and external loads based on the applicable pipe wall thickness.

*Working Pressure is based on rings both sides fully welded standard wall carbon steel pipe.

†Allowable Axial Displacement and Angular Movement (Deflection) figures shown are the maximum nominal range of movement at each R-88 coupling joint when rings are welded in the standard position. For design and installation purposes these figures should be reduced by 25%.

‡10mm shoulder rings are acceptable. The number of ring clamps listed is the minimum required to correctly position the weld ring around the circumference of the pipe end.

***Some pipe standards allow for increased variation in OD as size increases. Shurjoint recommends a tolerance limit of +/- 1.6mm (0.063") for sizes larger than 26". Buyer should consult with the pipe manufacturer to limit this variation on what is acceptable, as this may affect performance.



R-88N
14" - 26"

 Ensure coupling bolt pads make metal-to-metal contact.

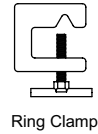

Ring Clamp

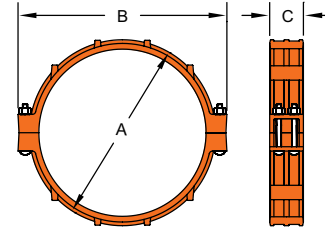
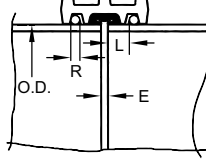

14" - 26"

DIMENSIONS

R88N (14"-26")

NOMINAL SIZE	PIPE O.D.	RINGS BOTH SIDES FULLY WELDED*		AXIAL DISPLACEMENT† E	ANGULAR MOVEMENT / DEFLECTION†		DIMENSIONS			BOLTS		SEALING SURFACE L	RING SIZE R	NO. OF WELD CLAMPS‡	WEIGHT
		MAX. WORKING PRESSURE (CWP)#	MAX. END LOAD (CWP)#		PER COUPLING	PER PIPE	A	B	C	NO.	SIZE				
in	in	PSI	lb	in	Deg.(°)	in / ft	in	in	in		in	in	in		lb
mm	mm	Bar	kN	mm		mm / m	mm	mm	mm		mm	mm	mm		Kg
14	14.000	350	53878	0-0.250	1.20	0.25	15.93	19.40	3.65	2	7/8 x 5-1/2	1.02	5/16	4	38.3
350	355.6	24	239.66	0-6.4		21	405	493	93		---	26	8.0		17.4
16	16.000	350	70372	0-0.250	0.90	0.19	17.92	21.52	3.65	2	7/8 x 5-1/2	1.02	5/16	4	35.0
400	406.4	24	313.03	0-6.4		16	455	547	93		---	26	8.0		15.9
18	18.000	350	89064	0-0.375	1.20	0.25	20.37	24.17	4.23	2	1 x 5-1/2	1.18	5/16	4	50.6
450	457.2	24	396.18	0-9.5		21	517	614	107		---	30	8.0		23.0
20	20.000	350	109956	0-0.375	1.08	0.23	22.46	25.99	4.35	2	1 x 5-1/2	1.18	3/8	4	68.7
500	508.0	24	489.11	0-9.5		19	570	660	110		---	30	9.5		31.2
24	24.000	350	158336	0-0.375	0.80	0.17	27.17	30.00	4.84	4	7/8 x 6-1/2	1.18	1/2	4	104.7
600	609.6	24	704.31	0-9.5		14	690	762	123		---	30	12.7		47.5
26	26.000	300	159279	0-0.500	1.06	0.22	29.58	32.78	6.69	4	1 x 8-7/8	1.97	1/2	4	173.5
650	660.4	20	708.51	0-12.7		18	751	832	170		---	50	12.7		78.7

Note: Dimensions are subject to change without notice. Other sizes are available on request

#Working Pressure and End Load are the total from all internal and external loads based on the applicable pipe wall thickness.

*Working Pressure is based on rings both sides fully welded standard wall carbon steel pipe.

†Allowable Axial Displacement and Angular Movement (Deflection) figures shown are the maximum nominal range of movement at each R-88 coupling joint when rings are welded in the standard position. For design and installation purposes these figures should be reduced by 25%.

‡ø10mm shoulder rings are acceptable. The number of ring clamps listed is the minimum required to correctly position the weld ring around the circumference of the pipe end.

***Some pipe standards allow for increased variation in OD as size increases. Shurjoint recommends a tolerance limit of +/- 1.6mm (0.063") for sizes larger than 26". Buyer should consult with the pipe manufacturer to limit this variation on what is acceptable, as this may affect performance.

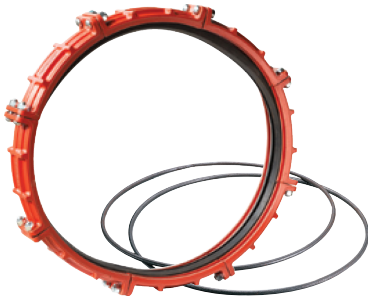

R-88
28" - 96"

Ensure coupling bolt pads make metal-to-metal contact.

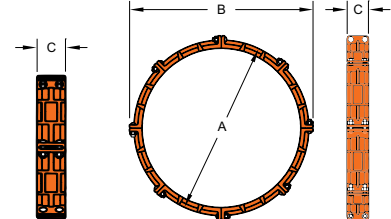
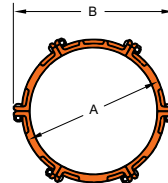
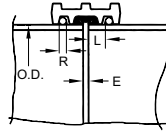
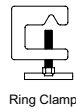

DIMENSIONS

R88 (28"-96")

NOMINAL SIZE	PIPE O.D.	RINGS BOTH SIDES FULLY WELDED*		AXIAL DISPLACEMENT† E	ANGULAR MOVEMENT / DEFLECTION †		DIMENSIONS			BOLTS		SEALING SURFACE L	RING SIZE R	NO. OF WELD CLAMPS‡	WEIGHT
		MAX. WORKING PRESSURE (CWP)#	MAX. END LOAD (CWP)#		PER CPLG	PER PIPE	A	B	C	NO.	SIZE				
in	in	PSI	lb	in	Deg.(°)	in / ft	in	in	in		in	in	in	in	lb
mm	mm	Bar	kN	mm		mm / m	mm	mm	mm		mm	mm	mm	mm	kg
28**	28.0	300	184725	0-0.500	0.90	0.19	31.75	35.47	6.69	12	7/8 x 4	2.00	1/2	4	222.2
700	711.2	20	821.70	0-12.7		16	806	901	170			50	12.7	4	101.0
30	30.0	300	212057	0-0.500	0.86	0.18	33.75	37.60	6.69	12	1 x 3-1/2	2.00	1/2	4	218.9
750	762.0	20	943.28	0-12.7		15	857	955	170			50	12.7	4	99.5
32	32.0	300	241274	0-0.500	0.84	0.18	35.75	39.45	6.69	12	1 x 3-1/2	2.00	1/2	4	225.4
800	812.8	20	1073.24	0-12.7		15	908	1002	170			50	12.7	4	102.2
34**	34.0	225	204282	0-0.500	0.84	0.18	37.75	41.50	7.87	12	1 x 3-1/2	2.00	1/2	4	253.0
850	863.4	16	908.69	0-12.7		15	959	1054	200			50	12.7	4	115.0
36	36.0	225	229022	0-0.500	0.76	0.16	39.75	43.50	7.87	12	1 x 3-1/2	2.00	1/2	4	246.0
900	914.4	16	1018.74	0-12.7		13	1010	1103	200			50	12.7	4	111.6
38**	38.0	225	255176	0-0.500	0.76	0.16	41.75	45.50	7.87	12	1 x 3-1/2	2.00	1/2	4	275.0
950	965.2	16	1135.08	0-12.7		13	1060	1156	200			50	12.7	4	125.0
40	40.0	225	282743	0-0.625	0.80	0.17	44.69	48.39	7.87	16	1 x 3-1/2	2.37	5/8	6	310.2
1000	1016.0	16	1257.70	0-15.9		14	1135	1229	200			60	15.9	6	141.0
42**	42.0	225	311724	0-0.625	0.86	0.18	46.70	50.71	7.87	16	1-1/4 x 5	2.37	5/8	6	326.9
1050	1066.8	16	1386.62	0-15.9		15	1186	1288	200			60	15.9	6	148.6
44**	44.0	225	342119	0-0.625	0.80	0.17	48.66	52.64	7.87	16	1-1/4 x 5	2.37	5/8	6	343.2
1100	1117.6	16	1521.82	0-15.9		14	1236	1337	200			60	15.9	6	156.0
48	48.0	225	407150	0-0.625	0.70	0.15	52.68	55.91	7.87	16	1 x 3-1/2	2.37	5/8	6	466.7
1200	1219.2	16	1811.09	0-15.9		12	1338	1420	200			60	15.9	6	211.8
52**	52.0	175	371650	0-0.625	---	---	61.25	60.67	7.87	16	1-1/4 x 5	2.37	5/8	6	453.2
1300	1320.8	12	1653.18	0-15.9		---	1555	1541	200			60	15.9	6	206.0
54**	54.0	175	400788	0-0.625	---	---	63.25	62.52	7.87	16	1-1/4 x 5	2.37	5/8	6	472.1
1350	1371.6	12	1782.79	0-15.9		---	1607	1588	200			60	15.9	6	214.6
56**	56.0	175	431026	0-0.625	---	---	65.38	64.69	7.87	16	1-1/4 x 5	2.37	5/8	6	488.2
1400	1422.4	12	1917.30	0-15.9		---	1660	1643	200			60	15.9	6	222.0
60**	60.0	175	494800	0-0.625	---	---	69.38	68.82	7.87	16	1-1/4 x 5	2.37	5/8	6	537.2
1500	1524.0	12	2200.98	0-15.9		---	1762	1748	200			60	15.9	6	244.2
66**	66.0	175	598709	0-0.750	---	---	76.00	75.75	8.00	16	1-1/2 x 5	2.37	3/4	8	612.5
1650	1676.4	12	2663.191	0-19.1		---	1932	1924	216			60	19.1	8	278.4
68	68.0	175	635544	0-0.750	---	---	78.50	78.03	8.00	16	1-1/2 x 5	2.37	3/4	8	785.4
1700	1727.2	12	2827.04	0-19.1		---	1994	1982	216			60	19.1	8	357.0
72	72.0	175	712513	0-0.750	---	---	82.50	82.28	8.00	16	1-1/2 x 6-7/8	2.37	3/4	8	737.7
1800	1828.8	12	3169.41	0-19.1		---	2095	2090	216			60	19.1	8	335.3
84**	84.0	100	554176	0-0.750	---	---	94.75	93.81	8.00	16	1-1/2 x 5	2.37	3/4	8	780.3
2100	2133.6	7	2465.10	0-19.1		---	2406	2383	216			60	19.1	8	354.7
96**	96.0	100	723822	0-0.750	---	---	106.75	106.54	8.00	16	1-1/2 x 5	2.37	3/4	8	823.2
2400	2438.4	7	3219.72	0-19.1		---	2711	2706	216			60	19.1	8	374.2

Note: Dimensions are subject to change without notice. Other sizes are available on request.
 #Working Pressure and End Load are the total from all internal and external loads based on the applicable pipe wall thickness.
 *Working Pressure is based on rings both sides fully welded standard wall carbon steel pipe.
 †Allowable Axial Displacement and Angular Movement (Deflection) figures shown are the maximum nominal range of movement at each R-88 coupling joint when rings are welded in the standard position. For design and installation purposes these figures should be reduced by 25%.
 The number of ring clamps listed is the minimum required to correctly position the weld ring around the circumference of the pipe end.
 ***Some pipe standards allow for increased variation in OD as size increases. Shurjoint recommends a tolerance limit of +/- 1.6mm (0.063") for sizes larger than 26". Buyer should consult with the pipe manufacturer to limit this variation on what is acceptable, as this may affect performance.



The Shurjoint Model RH-1000 coupling is a high pressure ring joint coupling for use with Sch. 40, Sch. 80 and heavier wall carbon steel pipelines. The coupling is comprised of two ductile iron heavy-wall housings, rubber gasket (EPDM or Nitrile) and two heat-treated track bolts and nuts and provides a fully restrained joint with maximum working pressure up to 1,000 psi (70 Bar) depending on the pipe used.

Two steel weld rings will be factory supplied with a coupling. Steel rings shall be always fully welded at both sides.

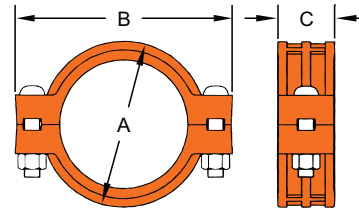
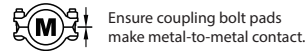

Pipe O.D.

DIMENSIONS

NOMINAL SIZE	PIPE O.D.	MAX. WORKING PRESSURE (CWP)*	MAX. END LOAD (CWP)	DIMENSIONS			BOLT / NUT ‡		DEFLECTION	PIPE-END PREPARATION			WEIGHT
				A	B	C	NO.	SIZE		R	L	E (MAX)	
in	in	PSI	lb	in	in	in		in	Deg.	in	in	in	lb
mm	mm	Bar	kN	mm	mm	mm				mm	mm	mm	kg
8	8.625	1000	58426	11.10	14.65	3.86	2	1 x 5-1/2	0° - 18'	0.472 - 0.500	1	0.13	39.8
200	219.1	69	259.89	282	372	98				12.0 - 12.7	25	3.2	18.1
10**	10.750	1000	90762	13.32	16.93	4.25	2	1 x 6-1/2	0° - 38'	0.472 - 0.500	1	0.13	57.2
250	273	69	403.73	340	430	108				12.0 - 12.7	25	3.2	26.0
12**	12.750	1000	127676	16.33	20.07	4.17	2	1 x 6-1/2	0° - 32'	0.472 - 0.500	1	0.13	72.6
300	323.9	69	567.93	415	510	106				12.0 - 12.7	25	3.2	33.0

*Working pressure is based on standard wall carbon steel pipe. Burst test pressures are minimum 2X the maximum working pressure.

**Non-standard / stock items may require longer lead time.

‡ Bolts & nuts are UNC threaded.



RX-3000 3000 PSI RING JOINT COUPLING

The Shurjoint Model RX-3000 coupling is a high pressure ring joint coupling for use with Sch. 80, 120 or heavier wall carbon steel pipelines. The coupling is comprised of two ductile iron heavy-wall housings, rubber gasket (EPDM or Nitrile) and two or four heat-treated track bolts and nuts which provide a fully restrained joint with maximum working pressure up to 3,000 psi (210 Bar) depending on the pipe used.

Two steel weld rings will be factory supplied with a coupling. Steel rings shall be always fully welded at both sides.

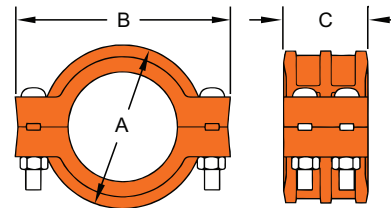
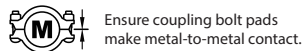

Pipe O.D.

DIMENSIONS

NOMINAL SIZE	PIPE O.D.	MAX. WORKING PRESSURE (CWP)*	MAX. END LOAD (CWP)	DIMENSIONS			BOLT / NUT ‡		PIPE-END PREPARATION			WEIGHT	
				A	B	C	NO.	SIZE	R	L	E (MAX)		
in	in	PSI	lb	in	in	in		in		in	in	in	lb
mm	mm	Bar	kN	mm	mm	mm				mm	mm	mm	kg
8	8.625	3000	1175279	11.81	15.51	5.83	2	1-1/8 x 5-1/8	0.472 - 0.500	1.22	1/8	78.92	
200	219.1	207	779.68	300	394	148			12.0 - 12.7	31	3	35.87	
10	10.748	3000	272287	14.96	18.93	5.98	4	1-1/4 x 6-1/2	0.625 - 0.629	1.22	1/8	116.36	
250	273.0	207	1211.19	380	481	152			15.9 - 16.0	31	3	52.78	
12**	12.752	3000	383029	18.50	22.48	6.81	4	1-1/2 x 6-1/4	0.625 - 0.629	1.22	1/8	212.27	
300	323.9	207	1703.80	470	572	173			15.9 - 16.0	31	3	96.24	

*Working pressure is based on API 5L X65 line pipe.

**Non-standard / stock items may require longer lead time.

‡ Bolts & nuts are UNC threaded.

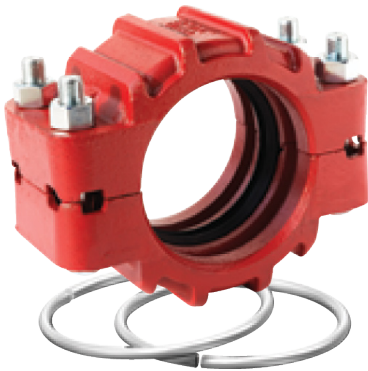

The Shurjoint Model RX-3770 Ring Joint Coupling is designed to provide a fully restrained joint for use with extra-strong carbon steel pipe including API 5L Grade X65 line pipe. The coupling is comprised of two ductile iron heavy-wall housing segments, rubber gasket (EPDM) and four heat-treated track bolts and nuts. Two steel weld rings are factory supplied with a coupling. Steel rings shall always be fully welded on both sides.

 Ensure coupling bolt pads make metal-to-metal contact.

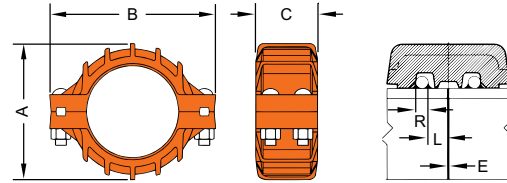

DIMENSIONS

NOMINAL SIZE	PIPE O.D.	MAX. WORKING PRESSURE (CWP)*	MAX. END LOAD (CWP)	DIMENSIONS			BOLT / NUT †		PIPE-END PREPARATION			WEIGHT
				A	B	C	NO.	SIZE	R	L	E (MAX)	
in	in	PSI	lb	in	in	in		in	in	in	lb	
mm	mm	Bar	kN	mm	mm	mm		mm	mm	mm	kg	
6	6.625	3770	129958	10.24	12.64	5.87	4	7/8 x 6-1/2	0.472	1.22	0.20	61.2
150	168.3	260	578.08	260	321	149			12	31	5	27.7
8	8.625	3770	220267	12.95	16.30	6.89	4	1-1/4 x 6-1/2	0.625	1.50	0.20	110.0
200	219.1	260	979.8	329	414	175			16	38	5	49.9
10	10.750	3770	3421752	15.90	19.84	7.72	4	1-1/2 x 6-7/8	0.750	1.50	0.20	174.5
250	273.0	260	1522.07	404	504	196			19	38	5	79.2
12	12.750	3770	481339	19.00	23.10	8.63	4	1-1/2 x 6-7/8	0.875	1.50	0.24	247.1
300	323.9	260	2141.10	482	587	219			22	38	6	112.3

*Working pressure is based on API 5L X65 line pipe. Burst test pressures are minimum 2X the maximum working pressure.
 † Bolts & nuts are UNC threaded.

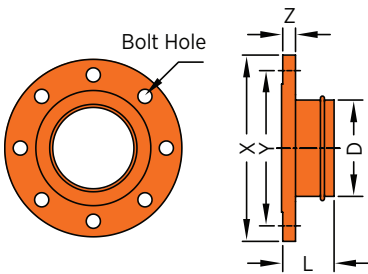

FLANGE ADAPTER ANSI CLASS 125/150

Material: Fabricated with ASTM A234 Gr. WPB, standard weight (0.375" or 9.5 mm), or segmentally welded carbon steel of the same or equivalent grade.

E-E dimensions: conform to ANSI B16.9.

DIMENSIONS

NOMINAL SIZE	PIPE O.D. D	RJ-70 FLANGE ADAPTER							L	WEIGHT
		X	Y	Z	BOLT SIZE	BOLT HOLE				
in	in	in	in	in	in	in	in	in	lb	
mm	mm	mm	mm	mm	mm	mm	mm	mm	kg	
8	8.625	13.500	11.750	1.125				6	44.9	
200	219.1	343.0	298.0	29.0	3/4	7/8	8	152	20.4	
10	10.750	16.000	14.250	1.180				8	67.1	
250	273.0	406.4	362.0	30.0	7/8	1	12	203	30.5	
12	12.750	19.000	17.000	1.250				8	98.1	
300	323.9	483.0	432.0	32.0	7/8	1	12	203	44.6	
14	14.000	21.000	18.750	1.377				8	118.8	
350	355.6	533.0	476.25	35.0	1	1-1/8	12	203	54.0	
16	16.000	23.500	21.250	1.456				8	147.0	
400	406.4	597.0	539.75	37.0	1	1-1/8	16	203	66.8	
18	18.000	25.000	22.751	1.059				8	143.0	
450	457.2	635.0	577.9	26.9	1-1/8	1-1/4	16	203	65.0	
20	20.000	27.519	25.000	1.692				8	169.4	
500	508.0	699.0	635.0	43.0	1-1/8	1-1/4	20	203	77.0	
24	24.000	32.031	29.500	1.889				8	286.9	
600	609.6	813.6	749.3	48.0	1-1/4	1-3/8	20	203	130.4	

L: Mfr's standard

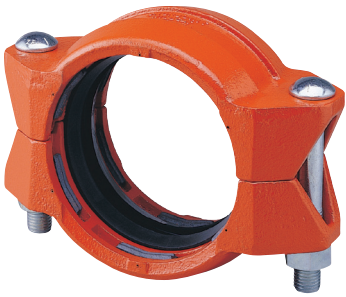

The Shurjoint Model 79 "Wildcat" coupling is designed to mechanically join plain-end or beveled end carbon steel pipe. The "Wildcat" couplings can be used for a variety of applications including mining, process piping, manifold piping and oilfield services. The "Wildcat" couplings feature case-hardened jaws* within the housings and large diameter heat treated track bolts that when tightened securely grip the pipe surface. As with grooved couplings, a C-shaped rubber gasket effectively seals the pipe ends. (*For sizes larger than 14" (350 mm), jaws are made of 17-4PH stainless steel.)

The Model 79 coupling is recommended for use on carbon steel pipe with a hardness less than HB150, not recommended for stainless steel, plastic, HDPE, cast iron or other brittle pipe.

Gaskets are available either in Grade E EPDM for water services of -29°F to + 230°F (-34°C to + 110°C) or Grade T Nitrile for oil services -20°F to +180°F (-29°C to +82°C).



Always fasten the bolts to the required torque.

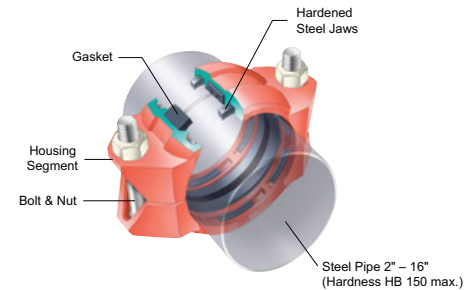
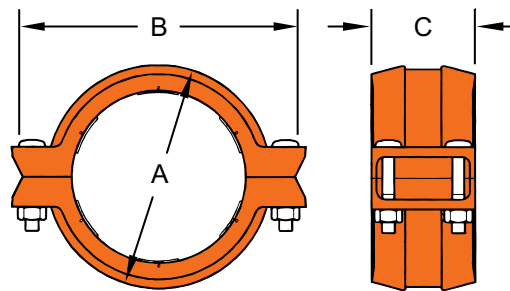

DIMENSIONS

NOMINAL SIZE	PIPE O.D.	MAX. WORKING PRESSURE*	MAX. END LOAD	REQUIRED BOLT TORQUE	BOLT		DIMENSIONS			WEIGHT
					NO.	SIZE	A	B	C	
in	in	PSI	lb	lb-ft		in	in	in	in	lb
mm	mm	Bar	kN	Nm			mm	mm	mm	kg
2	2.375	750	3320	150	2	5/8 x 3-1/2	3.75	5.94	3.54	7.0
50	60.3	52	14.84	200			95	151	90	3.2
2-1/2	2.875	600	3890	150	2	5/8 x 3-1/2	4.25	6.46	3.54	7.3
65	73.0	42	17.57	200			108	164	90	3.3
3	3.500	600	5770	200	2	3/4 x 4-3/4	5.00	7.48	3.54	11.0
80	88.9	42	26.06	270			127	190	90	5.0
4	4.500	450	7150	200	2	3/4 x 4-3/4	6.14	8.78	4.00	14.3
100	114.3	31	32.82	270			154	223	102	6.5
5	5.563	300	7290	250	2	7/8 x 6-1/2	7.36	10.31	4.38	24.2
125	141.3	20	32.91	340			187	262	111	11.0
6	6.625	300	10340	250	2	7/8 x 6-1/2	8.50	11.50	4.38	28.6
150	168.3	20	46.69	340			216	292	111	13.0
8	8.625	250	14600	200	4	3/4 x 4-3/4	10.88	14.02	5.00	41.8
200	219.1	17	64.06	270			276	356	127	19.0
10	10.750	250	22680	300	4	7/8 x 6-1/2	12.60	16.14	5.00	52.8
250	273.0	17	99.46	400			320	410	127	24.0
12	12.750	250	31900	350	4	1 x 6-1/2	14.60	18.54	5.00	63.1
300	323.9	17	140.00	470			371	471	127	28.7
14	14.000	200	30770	350	4	1 x 6-1/2	16.70	20.00	5.28	93.5
350	355.6	14	138.97	470			424	508	134	42.5
16	16.000	150	30140	350	4	1 x 6-1/2	18.70	22.00	5.28	95.7
400	406.4	10	129.65	470			475	559	134	43.5

*Working pressure is for plain-end standard wall steel pipe with hardness less than HB150.



HDPE
series



The Shurjoint Model H305 HDPE couplings feature four bolt housings and a series of sharply machined teeth which positively grip the pipe as the coupling bolts and nuts are tightened. The result is a leak-tight joint that is as strong, or stronger than the pipe itself. The H305 also features a contoured housing with integral ramps along the outside diameter to help the coupling slide over most obstacles during the relocation of pipe runs.

Working Pressure: Since the physical strength of the Shurjoint HDPE couplings is much greater than HDPE pipe, working pressures are governed by the working pressures of the HDPE pipe, which vary depending on pipe composition, wall thickness and service temperatures.

Shurjoint HDPE couplings are not intended for use on PVC, PP or other materials.

Shurjoint recommends the use of a silicone based lubricant for the HDPE series. Do not use the Shurjoint standard lubricant, which is designed for steel pipe use. Do not use hydrocarbon based oils, grease or soap based solutions either as this could lead joint failure. Gasket options include "E" EPDM or "T" Nitrile.

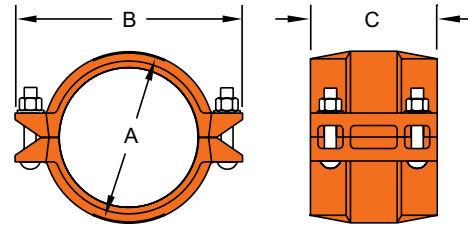
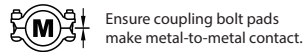

DIMENSIONS

IPS

NOMINAL SIZE	PIPE O.D.	DIMENSIONS			BOLT		WEIGHT
		A	B	C	NO.	SIZE	
in	in	in	in	in			lb
mm	mm	mm	mm	mm		in	kg
2	2.375	3.39	5.24	4.57	4	1/2 x 2-3/8	5.7
50	60.3	86	133	116	4	1/2 x 3	2.6
3	3.500	4.61	6.50	4.57	4	1/2 x 3	7.9
80	88.9	117	165	116	4	1/2 x 3	3.6
4	4.500	5.75	7.95	5.75	4	1/2 x 3	11.4
100	114.3	146	202	146	4	1/2 x 3	5.2
5	5.563	6.66	8.25	4.63	4	1/2 x 3	9.9
125	141.3	169	210	118	4	1/2 x 3	4.5
6	6.625	7.87	10.75	5.87	4	5/8 x 3-1/2	18.0
150	168.3	200	273	149	4	5/8 x 3-1/2	8.2
8	8.625	10.39	13.11	6.02	4	5/8 x 3-1/2	28.4
200	219.1	264	333	153	4	5/8 x 3-1/2	12.9
10	10.750	12.52	15.71	6.50	4	3/4 x 4-3/4	43.6
250	273.0	318	399	165	4	3/4 x 4-3/4	19.8
12	12.750	14.37	17.80	7.09	4	3/4 x 4-3/4	56.1
300	323.9	365	452	180	4	3/4 x 4-3/4	25.5
14	14.000	16.26	19.25	10.08	4	1 x 4-1/2	90.6
350	355.6	413	489	256	4	1 x 4-1/2	41.2
16	16.000	18.39	21.30	10.08	4	1 x 4-1/2	97.2
400	406.4	467	541	256	4	1 x 4-1/2	44.2
18	18.000	20.28	23.43	10.08	4	1 x 4-1/2	111.1
450	457.2	515	595	256	4	1 x 4-1/2	50.5
20	20.000	22.36	25.63	10.08	4	1 x 4-1/2	136.0
500	508.0	568	651	256	4	1 x 4-1/2	61.8



The Shurjoint Model H307 HDPE transition coupling provides for a fast, easy and direct transition from HDPE pipe and or fittings to grooved end steel pipe (IPS). The H307 couplings feature a four bolt housings and a combination of sharply machined teeth and a key section to form a leaktight seal when secured to both pipes. Like the H305 the H307 also features a contoured housing with integral ramps along the outside diameter

Working Pressure: Since the physical strength of the Shurjoint HDPE couplings is much greater than HDPE pipe, working pressures are governed by the working pressures of the HDPE pipe, which vary depending on pipe composition, wall thickness and service temperatures.

Shurjoint HDPE couplings are not intended for use on PVC, PP or other materials.

Shurjoint recommends the use of a silicone based lubricant for the HDPE series. Do not use the Shurjoint standard lubricant, which is designed for steel pipe use. Do not use hydrocarbon based oils, grease or soap based solutions either as this could lead joint failure. Gasket options include "E" EPDM or "T" Nitrile.



Ensure coupling bolt pads make metal-to-metal contact.

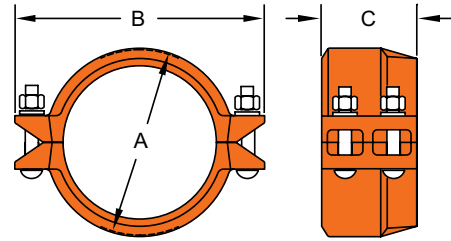

DIMENSIONS

IPS

NOMINAL SIZE	PIPE O.D.	DIMENSIONS			BOLT		WEIGHT
		A	B	C	NO.	SIZE	
in	in	in	in	in		in	lb
mm	mm	mm	mm	mm			kg
2	2.375	3.39	5.79	3.11	4	1/2 x 2-3/8	4.4
50	60.3	86	147	79			2.0
3	3.500	4.49	6.89	3.11	4	1/2 x 3	5.9
80	88.9	114	175	79			2.7
4	4.500	5.75	8.23	3.74	4	1/2 x 3	8.4
100	114.3	146	209	95			3.8
6	6.625	8.00	11.02	3.74	4	5/8 x 3-1/2	12.5
150	168.3	203	280	95			5.7
8	8.625	10.51	13.46	4.25	4	5/8 x 3-1/2	21.3
200	219.1	267	342	108			9.7
10	10.750	12.64	16.69	5.00	4	3/4 x 4-3/4	35.2
250	273.0	321	424	127			16.0
12	12.750	14.76	19.02	5.00	4	3/4 x 4-3/4	43.1
300	323.9	375	483	127			19.6

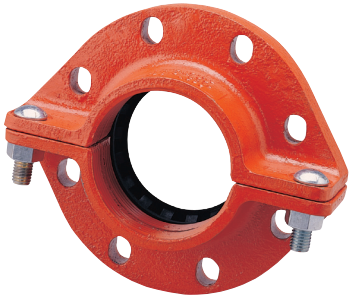

The Shurjoint Model H312 HDPE flange adapter provides for the direct transition from HDPE pipe or fittings to ANSI class 125 or 150 flanged components. The H312 can be rotated for fast and easy bolt alignment prior to tightening. The gasket seals both on the outside of the pipe and to the flange face providing a leak-tight seal when secured in place.

Working Pressure: Since the physical strength of the Shurjoint HDPE couplings is much greater than HDPE pipe, working pressures are governed by the working pressures of the HDPE pipe, which vary depending on pipe composition, wall thickness and service temperatures.

Shurjoint HDPE couplings are not intended for use on PVC, PP or other materials.

Shurjoint recommends the use of a silicone based lubricant for the HDPE series. Do not use the Shurjoint standard lubricant, which is designed for steel pipe use. Do not use hydrocarbon based oils, grease or soap based solutions either as this could lead joint failure. Gasket options include "E" EPDM or "T" Nitrile.



Ensure coupling bolt pads make metal-to-metal contact.

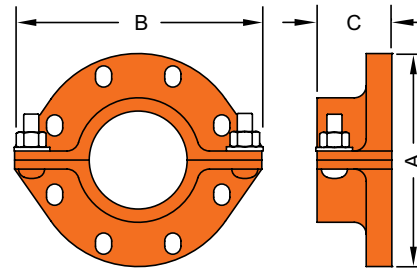

DIMENSIONS

IPS

NOMINAL SIZE	PIPE O.D.	DIMENSIONS			BOLT		FLANGE BOLT / NUT*		WEIGHT
		A	B	C	NO.	SIZE	NO.	SIZE	
in	in	in	in	in		in		in	lb
mm	mm	mm	mm	mm					kg
3	3.500	7.75	8.86	3.10	2	5/8 x 2-1/8	4	5/8	10.6
80	88.9	197	225	79					4.8
4	4.500	9.00	10.25	3.10	2	5/8 x 2-1/8	8	5/8	15.0
100	114.3	229	260	79					6.8
6	6.625	11.00	12.25	3.75	2	5/8 x 2-1/8	8	3/4	21.5
150	168.3	279	311	95					9.8
8	8.625	13.50	14.75	3.42	2	3/4 x 2-3/8	8	3/4	28.8
200	219.1	343	375	87					13.1
10	10.750	16.00	21.00	4.25	4	3/4 x 2-3/8	12	7/8	42.9
250	273.0	406	533	108					19.5
12	12.750	19.02	24.00	4.25	4	3/4 x 2-3/8	12	7/8	51.5
300	323.9	483	610	108					23.4

Specified bolt torque is required for flange connection. See page 125 in the Shurjoint Installation Instructions.





**copper
series**

The Shurjoint copper series is the most complete line of grooved components available for installation on copper tubing (CTS) in sizes 2" - 6" (50 mm - 150 mm) Shurjoint grooved mechanical components provide a fast, easy, economical and durable joining method of copper tubing without the use of heat or solder.

COPPER TUBING DIMENSIONS & PRESSURE RATINGS (ASTM B88 & B306)

NOMINAL SIZE	TYPE	D PIPE OD	T THICKNESS		P MAX. PRESSURE	
			IN	MM	PSI	Bar
2	"K L M DWW"	2.125	"0.082 0.070 0.058 0.042"	"2.11 1.78 1.47 1.07"	"484 406 335 241"	"33 28 23 17"
50		54				
2-1/2	"K L M DWW"	2.625	"241 2.03 1.65 NA"	"2.41 2.03 1.65 NA"	"447 375 303 NA"	1 26 21 N/A
65		66.7				
3	"K L M DWW"	3.125	"0.109 0.090 0.072 0.045"	"2.77 2.29 1.83 1.14"	431 354 282 175	30 24 19 12
80		79.4				
4	"K L M DWW"	4.125	"0.134 0.110 0.065 0.058"	"3.40 2.79 2.41 1.47"	400 327 282 171	28 23 19 12
100		104.8				
5	"K L M DWW"	5.125	"0.160 0.125 0.109 0.072"	"4.06 3.12 2.77 1.83"	"400 327 282 171"	"28 23 19 12"
125		130.2				
6	"K L M DWW"	6.125	"0.192 0.140 0.122 0.083"	"4.88 3.56 3.10 2.11"	"386 279 243 164"	"27 19 17 11"
150		155.6				

- Notes:
1. Design stress: 6000 psi (41.4 MPa)
2. Pressures are based on water at 73.4°F (23°C).

PIPE O.D.

Maximum allowable tolerances from square cut ends is 0.03" for 2" thru 3"; 0.045" for 4" thru 6"; and 0.060" for sizes 8".

GASKET SEATING SURFACE

The gasket seating surface shall be free from deep scores, marks, or ridges that would prevent a positive seal.

GROOVE WIDTH

Groove width is to be measured between vertical flanks of the groove side walls.

GROOVE DIAMETER

The "C" diameters are average values. The groove must be of uniform depth around the entire pipe circumference.

NOMINAL SIZE	PIPE O.D. BASIC SIZE	A GASKET SEAT ±0.03 / ±0.79	B GROOVE WIDTH ±0.03 / ±0.79	C GROOVE DIA. +0/-0.02 / +0/-0.51	D GROOVE DEPTH (REF)	T MIN. ALLOWED WALL THICK.	F MAX. ALLOWED FLARE DIA.
in	in	in	in	in	in	in	in
mm	mm	mm	mm	mm	mm	mm	mm
2	2.125	0.610	0.300	2.029	0.048	0.064	2.220
50	54.0	15.5	7.6	51.5	1.2	1.6	56.4
2-1/2	2.625	0.610	0.300	2.525	0.050	0.065	2.720
65	66.7	15.5	7.6	64.1	1.3	1.7	69.1
3	3.125	0.610	0.300	3.025	0.050	DWV	3.220
80	79.4	15.5	7.6	76.8	1.3		81.8
4	4.125	0.610	0.300	4.019	0.053	DWV	4.220
100	104.8	15.5	7.6	102.1	1.4		107.2
5	5.125	0.610	0.300	4.999	0.053	DWV	5.220
125	130.2	15.5	7.6	127.0	1.4		132.6
6	6.125	0.610	0.300	5.999	0.063	DWV	6.220
150	155.6	15.5	7.6	152.3	1.6		158.0

Grooved-end fittings are produced from bronze castings. Bronze castings are produced from lead-free alloys C89836 and or C83470* Bismuth copper alloy per ASTM B584. Materials are in compliance with NSF/ANSI 61 for potable water service applications.

STANDARD ROLL GROOVE FOR U.S. STANDARD COPPER TUBING

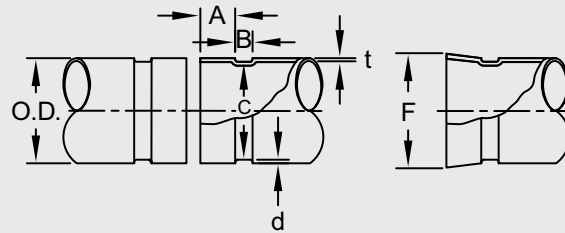

- Bronze fittings marked with C83470 designation are in compliance with NSF/ANSI 61 and NSF/ANSI 372.

ROLL SET

As copper tubing is thinner than carbon steel pipe, always use a roll set specifically designed for use on copper tubing.

GROOVE DEPTH

The "d" is for reference use only. The groove dimension shall be determined by the groove diameter "C".

MINIMUM WALL THICKNESS

The DWV pipe (ASTM B-306) is minimum wall thickness that may be roll grooved.

FLARE DIAMETER

The pipe end that may flare when the groove is rolled shall be within this limit when measured at the extreme end of the pipe.

C305 RIGID COUPLING FOR COPPER TUBING (CTS)

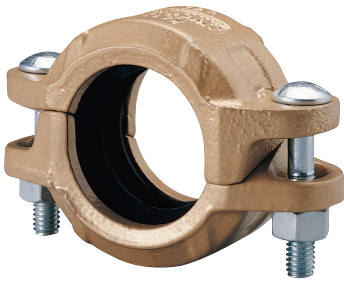

The Model C305 Rigid Coupling is ideal for joining copper tubing (CTS) in sizes 2" - 6". The C305 provides a fast, easy, economical and durable method of joining copper tubing without the use of heat or lead. The C305 features an angle pad design for a rigid joint and easy swing-over installation. The C305 features a pressure responsive EPDM GapSeal gasket which seals both the outside of the tubing and the gap between the tubing ends isolating the fluid from coupling housings. The C305 is rated up to 300 psi (20 bar), depending on the type and size of copper tubing used.

Applicable copper tubing:

- ASTM B-88 Type K, Type L, and Type M Seamless Copper Water Tube
- ASTM B306 Copper Drainage Tuber (DWV)



Ensure coupling bolt pads make metal-to-metal contact.



ROLL SET

As copper tubing is thinner than carbon steel pipe, always use a roll set specifically designed for use on copper tubing.

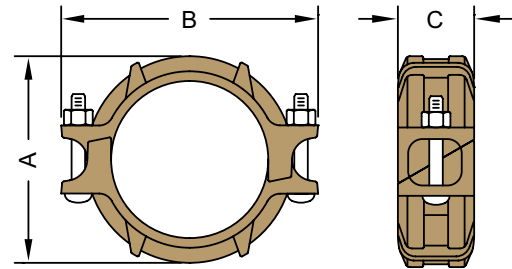

DIMENSIONS

TYPE K, L, M (ASTM B-88) & TYPE DWV (ASTM B306)

NOMINAL SIZE	PIPE O.D.	MAX. WORKING PRESSURE (CWP)*	MAX. END LOAD (CWP)	PIPE END SEPARATION	DIMENSIONS			BOLT SIZE	WEIGHT
					A	B	C		
in	in	PSI	in	in	in	in	in	in	lb
mm	mm	Bar	mm	mm	mm	mm	mm		kg
2	2.125	300	1060	0.06	3.17	4.63	1.89	3/8 x 2-1/8	1.8
50	54.0	20	4.58	1.5	81	118	48		0.8
2-1/2	2.625	300	1620	0.06	3.66	5.28	1.89	3/8 x 2-1/8	2.0
65	66.7	20	6.98	1.5	93	134	48		0.9
3	3.125	300	2290	0.06	4.21	6.06	1.89	1/2 x 3	2.8
80	79.4	20	9.90	1.5	107	154	48		1.3
4	4.125	300	4000	0.06	5.20	7.28	1.89	1/2 x 3	3.5
100	104.8	20	17.24	1.5	132	185	48		1.6
5	5.125	300	6180	0.06	6.26	8.66	1.89	5/8 x 3-1/2	4.6
125	130.2	20	26.61	1.5	159	220	48		2.2
6	6.125	300	8830	0.06	7.24	9.76	1.89	5/8 x 3-1/2	5.5
150	155.6	20	38.01	1.5	184	248	48		2.5

*Working pressure is for connection with roll-grooved Type K copper tubing.

Notes / Options: Couplings with rubber gaskets are likely to function as an insulator. Where electrical continuity is required, the Shurjoint Model 96 Continuity Clip will restore electrical continuity to the system. The continuity clip satisfies IEE Wiring Regulations.

C306 REDUCING COUPLING FOR COPPER TUBING (CTS)



The Model C306 Reducing Coupling allows direct reduction on a piping run and eliminates the need for a concentric reducer and couplings. The epoxy coated ductile iron coupling housings help to eliminate galvanic local cell and stray current problems. The specially designed rubber gasket prevents the smaller pipe from telescoping into the larger pipe during vertical installation.

Applicable copper tubing:

- ASTM B-88 Type K, Type L, and Type M Seamless Copper Water Tube
- ASTM B306 Copper Drainage Tuber (DWV)

ROLL SET

As copper tubing is thinner than carbon steel pipe, always use a roll set specifically designed for use on copper tubing.

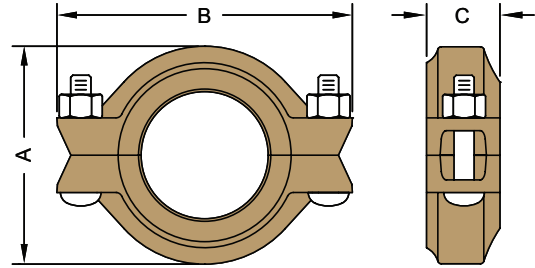

Ensure coupling bolt pads make metal-to-metal contact.



DIMENSIONS

NOMINAL SIZE	PIPE O.D.	MAX. WORKING PRESSURE (CWP)*	MAX. END LOAD (CWP)	PIPE END SEPARATION	DEFLECTION		DIMENSIONS			BOLT SIZE	WEIGHT
					DEG. PER COUPLING	PIPE	A	B	C		
in	in	PSI	lb	in	(°)	in / ft	in	in	in	in	lb
mm	mm	Bar	kN	mm		mm / m	mm	mm	mm		kg
2-1/2 x 2	2.625 x 2.215	300	1622	0.06	1° - 22'	0.29	3.70	5.55	1.77	1/2 x 3	2.9
65 x 50	66.7 x 54.0	20	6.98	1.6		24.0	94	141	45		1.3
3 x 2	3.125 x 2.125	300	2300	0.06	1° - 09'	0.24	4.21	5.98	1.77	1/2 x 3	3.3
80 x 50	79.4 x 54.0	20	9.89	1.6		20.0	107	152	45		1.5
3 x 2-1/2	3.125 x 2.625	300	2300	0.06	1° - 09'	0.24	4.21	5.98	1.77	1/2 x 3	3.0
80 x 65	79.4 x 66.7	20	9.89	1.6		20.0	107	152	45		1.4
4 x 2-1/2	4.125 x 2.625	300	4007	0.06	0° - 53'	0.18	5.20	7.20	1.77	1/2 x 3	4.2
100 x 65	104.8 x 66.7	20	17.23	1.6		15.0	132	183	45		1.9
4 x 3	4.125 x 3.125	300	4007	0.06	0° - 53'	0.18	5.20	7.20	1.77	1/2 x 3	4.0
100 x 80	104.8 x 79.4	20	17.23	1.6		15.0	132	183	45		1.8
5 x 4	5.125 x 4.125	300	6186	0.06	0° - 42'	0.15	6.30	8.82	1.77	5/8 x 3-1/2	5.5
125 x 100	130.2 x 104.8	20	26.60	1.6		12.0	160	224	45		2.5
6 x 4	6.125 x 4.125	300	8835	0.06	0° - 36'	0.13	7.28	9.88	1.77	5/8 x 3-1/2	7.3
150 x 100	155.6 x 104.8	20	37.99	1.6		10.3	185	251	45		3.3

*Working pressure is for connection with roll-grooved Type K copper tubing.

Notes / Options: Couplings with rubber gaskets are likely to function as an insulator. Where electrical continuity is required, the Shurjoint Model 96 Continuity Clip will restore electrical continuity to the system. The continuity clip satisfies IEE Wiring Regulations.

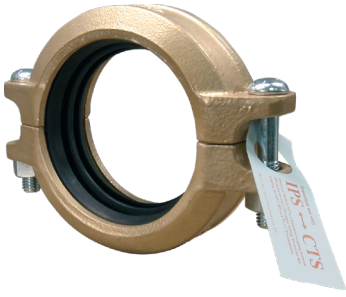

The Model C307 Transition Coupling provides for a direct connection between grooved end IPS steel pipe, fittings or valves and grooved end CTS copper tubing. The C307 is comprised of two ductile iron housings, pressure responsive rubber gasket and track bolts and nuts. The rubber gasket isolates the fluid from coupling housings and the epoxy coated housings help eliminate galvanic local cell and stray current problems.

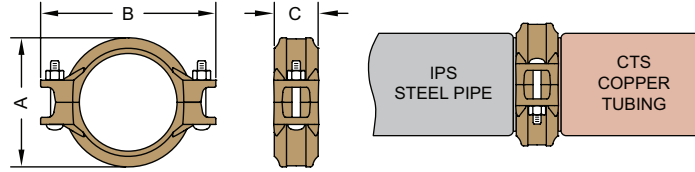

Ensure coupling bolt pads make metal-to-metal contact.

ROLL SET

As copper tubing is thinner than carbon steel pipe, always use a roll set specifically designed for use on copper tubing.

DIMENSIONS

NOMINAL SIZE	PIPE O.D. IPS X CTS	MAX. WORKING PRESSURE (CWP)*	AXIAL DISPLACEMENT	DEFLECTION	DIMENSIONS			BOLT SIZE	WEIGHT
					A	B	C		
in	in	PSI	in	(°)	in	in	in	in	lb
mm	mm	Bar	mm		mm	mm	mm		kg
2	2.375 x 2.125	300	0 - 0.06		3.31	5.00	1.81		2.0
50	60.3 x 54.0	20	0 - 1.6	1° - 31'	84	127	46	1/2 x 2-1/8	0.9
2-1/2	2.875 x 2.625	300	0 - 0.06		3.90	5.59	1.81		2.2
65	73.0 x 66.7	20	0 - 1.6	1° - 15'	99	142	46	3/8 x 2-1/8	1.0
3	3.500 x 3.125	300	0 - 0.06		4.57	6.38	1.81		3.0
80	88.9 x 79.4	20	0 - 1.6	1° - 02'	116	162	46	1/2 x 3	1.4
4	4.500 x 4.125	300	0 - 0.06		5.71	6.69	1.85		4.2
100	114.3 x 104.8	20	0 - 1.6	1° - 36'	145	170	47	1/2 x 3	1.9
6	6.625 x 6.125	300	0 - 0.06		8.03	10.59	1.97		7.3
150	168.3 x 155.6	20	0 - 1.5		204	269	50	5/8 x 3-1/2	3.3

*Working pressure is for connection with roll-grooved Type K copper tubing.

Notes / Options: Couplings with rubber gaskets are likely to function as an insulator. Where electrical continuity is required, the Shurjoint Model 96 Continuity Clip will restore electrical continuity to the system. The continuity clip satisfies IEE Wiring Regulations.

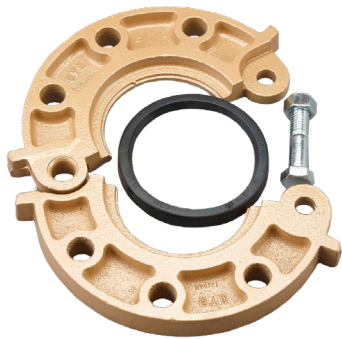

C341 FLANGE ADAPTER FOR COPPER TUBING (CTS)

The Model C341 Flange allows for the direct connection of grooved-end copper tubing with ANSI class 125/150 (steel) or ASME B16.24 (copper) class 150 flanged components without the need for heat or solder. Available in sizes 2" - 6" (50 mm - 150 mm) the Model C341 is supplied hinged as a single assembly with a set of hex-head bolt and nut and a pressure responsive gasket. The pressure responsive gasket seals on the outside diameter of the copper tubing and isolates the flange segments from the internal fluid. Pressure rating: up to 300 psi (20 bar) depending on the size and type of copper tubing being used.

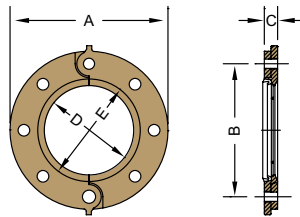

Some connections may require the use of a Model 49 sandwich plate which can be found on page 28 of this catalog. Further information can be found on the C341 submittal sheet, or contact Shurjoint for details.



ROLL SET

As copper tubing is thinner than carbon steel pipe, always use a roll set specifically designed for use on copper tubing.

DIMENSIONS

NOMINAL SIZE	PIPE O.D.	MAX. WORKING PRESSURE (CWP)*	DIMENSIONS					BOLT		WEIGHT
			A	B	C	D	E	NO.	SIZE	
in	in	PSI	in	in	in	in	in		in	lb
mm	mm	Bar	mm	mm	mm	mm	mm			kg
2	2.125	300	6.00	4.75	0.75	2.13	3.20	4	5/8 x 3	4.6
50	54.0	20	152	121	19	54	81			2.1
2-1/2	2.625	300	7.00	5.50	0.87	2.63	3.91	4	5/8 x 3	6.6
65	66.7	20	178	140	22	67	99			3.0
3	3.125	300	7.50	6.00	0.94	3.13	4.53			7.7
80	79.4	20	190	152	24	80	115	4	5/8 x 3	3.5
4	4.125	300	9.00	7.50	0.94	4.13	5.53	4	5/8 x 3	9.5
100	104.8	20	229	191	24	105	140			4.3
5	5.125	300	10.00	8.50	0.94	5.13	6.71	8	3/4 x 3-1/2	12.8
125	130.2	20	254	216	24	130	170			5.8
6	6.125	300	11.00	9.50	1.00	6.13	7.79			13.6
150	155.6	20	279	241	25	156	198	8	3/4 x 3-1/2	6.2

* Working Pressure is for connection with roll-grooved Type K copper tubing

** Please note that 2", 2-1/2", and 3" Model C341 Flanges cannot be used for making direct connections to Model SJ-C300 Butterfly Valves due to bolt pad interference with the valve.

Specified bolt torque is required. See page 108 in the Shurjoint Installation Instructions.

GROOVED FITTINGS FOR COPPER TUBING



C10 90° Elbow | C20 Tee
 C11 45° Elbow | C60 Cap



Shurjoint grooved-end fittings are produced from bronze castings. Bronze castings are produced from lead-free alloy C89836 Bismuth copper alloy per ASTM B584. Materials meet the requirement for potable water service applications. Shurjoint fittings are designed for use with Shurjoint CTS couplings, components and ASTM B-88 roll grooved copper tubing type K, L, M and ASTM B-306 DWV.

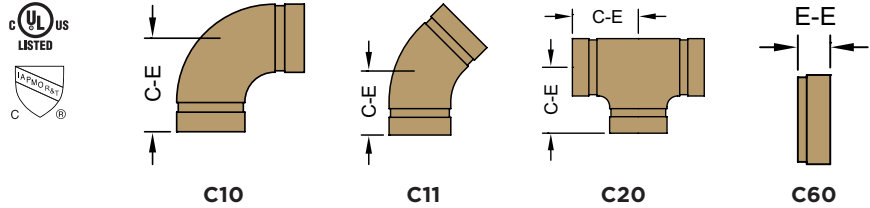

DIMENSIONS

NOMINAL SIZE	PIPE O.D.	C10 90° ELBOW		C11 45° ELBOW		C20 TEE		C60 CAP	
		C-E	WEIGHT	C-E	WEIGHT	C-E	WEIGHT	E-E	WEIGHT
in	in	in	lb	in	lb	in	lb	in	lb
mm	mm	mm	kg	mm	kg	mm	kg	mm	kg
2	2.125	2.91	1.5	2.19	1.7	2.44	1.8	0.96	0.6
50	54.0	74	0.7	56	0.8	62	0.8	24	0.3
2-1/2	2.625	3.31	2.0	2.31	2.1	3.20	2.9	0.96	0.9
65	66.7	84	0.9	59	1.0	81	1.3	24	0.4
3	3.125	3.81	2.6	2.59	3.2	3.50	3.7	0.96	1.2
80	79.4	97	1.2	66	1.4	89	1.7	24	0.6
4	4.125	4.75	5.5	3.35	5.5	4.25	7.3	0.96	2.1
100	104.8	121	2.5	85	2.5	108	3.3	24	1.0
5	5.125	5.94	11.5	3.25	7.9	5.94	17.2	0.96	3.5
125	130.2	151	5.2	83	3.6	151	7.8	24	1.6
6	6.125	6.94	16.5	3.63	10.2	6.94	26.2	0.96	4.4
150	155.6	176	7.5	92	4.6	176	11.9	24	2.0

C21 Reducing tee
C50 Concentric reducer

C26 Reducing tee (Gr X Gr X Cup)

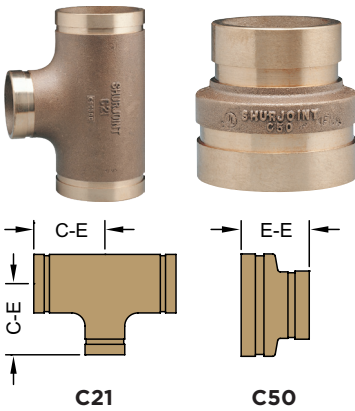

DIMENSIONS

NOMINAL SIZE	PIPE O.D.	C21 REDUCING TEE		C50 CONCENTRIC REDUCER	
		C-E	WEIGHT	E-E	WEIGHT
in	in	in	lb	in	lb
mm	mm	mm	kg	mm	kg
2-1/2 x 2	2.625 x 2.125	3.20	3.6	2.50	1.2
65 x 50	66.7 x 54.0	81	1.6	64	0.6
3 x 2	3.125 x 2.125	3.50	4.8	2.50	1.5
80 x 50	79.4 x 54.0	89	2.2	64	0.7
3 x 2-1/2	3.125 x 2.625	3.50	4.8	2.50	1.5
80 x 65	79.4 x 66.7	89	2.2	64	0.7
4 x 2	4.125 x 2.125	4.25	7.7	3.00	2.5
100 x 50	104.8 x 54.0	108	3.5	76	1.2
4 x 2-1/2	4.125 x 2.625	4.25	7.9	3.00	2.6
100 x 65	104.8 x 66.7	108	3.6	76	1.2
4 x 3	4.125 x 3.125	4.25	8.1	3.00	2.5
100 x 80	104.8 x 79.4	108	3.7	76	1.1
5 x 3	5.125 x 3.125	5.94	16.7	3.50	4.4
125 x 80	130.2 x 79.4	151	7.6	89	2.0
5 x 4	5.125 x 4.125	5.94	17.2	3.50	4.4
125 x 100	130.2 x 104.8	151	7.8	89	2.0
6 x 2-1/2	6.125 x 2.625	6.94	22.9	4.00	6.0
150 x 65	155.6 x 66.7	176	10.4	102	2.7
6 x 3	6.125 x 3.125	6.94	23.5	4.00	6.0
150 x 80	155.6 x 79.4	176	10.7	102	2.7
6 x 4	6.125 x 4.125	6.94	23.5	4.00	5.8
150 x 100	155.6 x 104.8	176	10.7	102	2.7
6 x 5	6.125 x 5.125	6.94	26.2	4.00	5.9
150 x 125	155.6 x 130.2	176	11.9	102	2.7

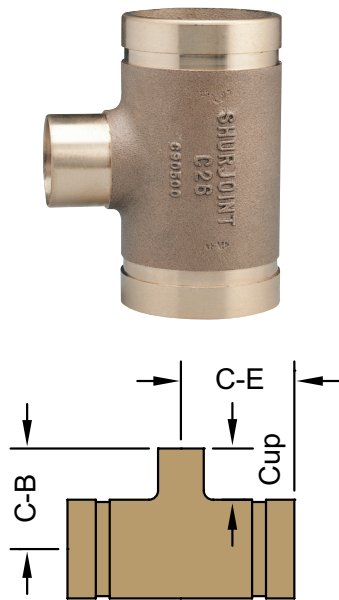

DIMENSIONS

NOMINAL SIZE	C26 RED. TEE (GR X GR X CUP)			WEIGHT
	C-E	C-B	CUP	
in	in	in	in	lb
mm	mm	mm	mm	kg
2 x 2 x 3/4	2.20	1.97	0.75	1.6
50 x 50 x 20	56	50	19	0.7
2 x 2 x 1	2.33	2.20	0.91	1.6
50 x 50 x 25	59	56	23	0.7
2 x 2 x 1-1/4	2.48	2.36	0.97	1.7
50 x 50 x 32	63	60	25	0.8
2 x 2 x 1-1/2	2.56	2.28	1.09	2.0
50 x 50 x 40	65	58	28	0.9
2-1/2 x 2-1/2 x 3/4	2.25	2.25	0.75	1.9
65 x 65 x 20	57	57	19	0.9
2-1/2 x 2-1/2 x 1	2.40	2.41	0.91	2.2
65 x 65 x 25	61	61	23	1.0
2-1/2 x 2-1/2 x 1-1/4	2.52	2.55	0.97	2.3
65 x 65 x 32	64	65	25	1.1
2-1/2 x 2-1/2 x 1-1/2	2.70	2.67	1.09	2.6
65 x 65 x 40	69	68	28	1.2
2-1/2 x 2-1/2 x 2	2.95	2.84	1.34	3.0
65 x 65 x 50	75	72	34	1.4
3 x 3 x 3/4	2.44	2.50	0.75	2.9
80 x 80 x 20	62	64	19	1.3
3 x 3 x 1	2.54	2.80	0.91	2.9
80 x 80 x 25	65	71	23	1.3
3 x 3 x 1-1/4	2.63	2.87	0.97	3.1
80 x 80 x 32	67	73	25	1.4
3 x 3 x 1-1/2	2.85	2.99	1.09	3.3
80 x 80 x 40	72	76	28	1.5
3 x 3 x 2	3.11	3.09	1.34	3.7
80 x 80 x 50	79	78	34	1.7
4 x 4 x 3/4	3.00	2.95	0.75	4.8
100 x 100 x 20	76	75	19	2.2
4 x 4 x 1	3.10	3.23	0.91	5.1
100 x 100 x 25	79	82	23	2.3
4 x 4 x 1-1/4	3.25	3.46	0.97	5.5
100 x 100 x 32	83	88	25	2.5
4 x 4 x 1-1/2	3.35	3.66	1.09	5.6
100 x 100 x 40	85	93	28	2.5
4 x 4 x 2	3.62	3.59	1.34	5.9
100 x 100 x 50	92	91	34	2.7

GROOVED FITTINGS FOR COPPER TUBING



C52 Concentric reducer (gr x cup)
C55 Transition adapter (ips x cts)



DIMENSIONS

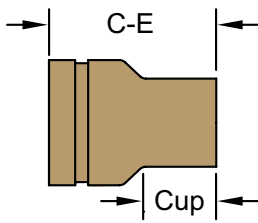

NOMINAL SIZE	C52 CONCENTRIC REDUCER (GR X CUP)		
	E-E	CUP	WEIGHT
in	in	in	lb
mm	mm	mm	lg
2 x 3/4	---	---	---
50 x 20	---	---	---
2 x 1	2.70	0.91	0.7
50 x 25	69	23	0.3
2 x 1-1/4	3.00	0.97	0.8
50 x 32	76	25	0.4
2 x 1-1/2	2.94	1.09	0.8
50 x 40	75	28	0.4
2-1/2 x 3/4	---	---	---
65 x 20	---	---	---
2-1/2 x 1	3.19	0.91	1.2
65 x 25	81	23	0.5
2-1/2 x 1-1/4	3.19	0.97	1.2
65 x 32	81	25	0.5
2-1/2 x 1-1/2	3.19	1.09	1.2
65 x 40	81	28	0.5
2-1/2 x 2	3.19	1.34	1.2
65 x 50	81	34	0.5
3 x 3/4	---	---	---
80 x 20	---	---	---
3 x 1	---	---	---
80 x 25	---	---	---
3 x 1-1/4	---	---	---
80 x 32	---	---	---
3 x 1-1/2	3.68	1.09	1.7
80 x 40	93	28	0.8
3 x 2	3.94	1.34	1.9
80 x 50	100	34	0.9
4 x 3/4	---	---	---
100 x 20	---	---	---
4 x 1	---	---	---
100 x 25	---	---	---
4 x 1-1/4	---	---	---
100 x 32	---	---	---
4 x 1-1/2	---	---	---
100 x 40	---	---	---
4 x 2	4.56	1.34	3.2
100 x 50	116	34	1.4

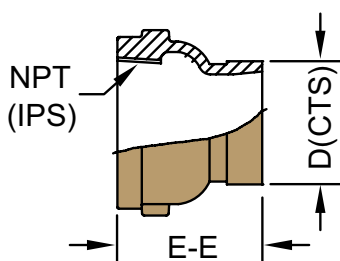

The Model C55 Transition Adapter provides for a direct transition between male threaded-end steel pipe (IPS) and grooved-end copper tubing. The C55 is UL classified to NSF/ANSI 61 and NSF/ANSI 372 for use in potable water systems.

DIMENSIONS

NOMINAL SIZE IPS (NPT) X CTS (GRV)	ACTUAL PIPE O.D.		E-E	WEIGHT
	STEEL PIPE (IPS) O.D.	COPPER TUBING (CTS) D		
in	in	in	in	lb
mm	mm	mm	mm	kg
1-1/2 x 2	1.900	2.125	2.50	1.3
40 x 50	48.3	54.0	63	0.6
2 x 2	2.375	2.125	2.50	1.4
50 x 50	60.3	54.0	63	0.7
2-1/2 x 2-1/2	2.875	2.625	2.75	2.4
65 x 65	73.0	66.7	70	1.1
3 x 3	3.500	3.125	3.00	3.3
80 x 80	88.9	79.4	76	1.5

DE30-GG Dielectric Transition Fitting
(IPS x CTS)



The Model DE30-GG Dielectric Transition Fitting provides a direct transition between a grooved-end steel pipe (IPS) and grooved end copper tubing. The fittings internal lining effectively eliminates galvanic local cell and stray current problems. The Model DE30-GG is designed for use at temperatures from -40°F to 230°F (-40°C to 110°C) and pressures up to 300 psi (20 bar). The DE-30GG is NSF-61 approved to 82°C (180°F)

MATERIAL SPECIFICATIONS

- Housing: Ductile Iron conforming to ASTM A536, electro-deposition coated.
- Liner: Virgin polypropylene to ASTM D4101.

ROLL SET

As copper tubing is thinner than carbon steel pipe, always use a roll set specifically designed for use on copper tubing.

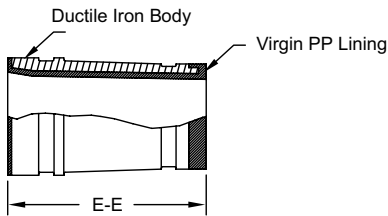

DIMENSIONS

NOMINAL SIZE	ACTUAL PIPE O.D.		E-E	WEIGHT
	STEEL PIPE	COPPER TUBING		
in	in	in	in	lb
mm	mm	mm	mm	kg
2	2.375	2.125	4.00	1.3
50	60.3	54.0	102	0.6
2-1/2	2.875	2.625	4.00	1.9
65	73.0	66.7	102	0.9
3	3.500	3.125	4.00	2.9
80	88.9	79.4	102	1.3
4	4.500	4.125	4.00	3.3
100	114.3	104.8	102	1.5
5	5.563	5.125	4.00	5.2
125	141.3	130.2	102	2.4
6	6.625	6.125	4.00	6.9
150	168.3	155.6	102	3.1
8	8.625	8.125	4.00	9.4
200	219.1	206.4	102	4.3

C723 BRONZE MECHANICAL TEE FOR COPPER TUBING (CTS)

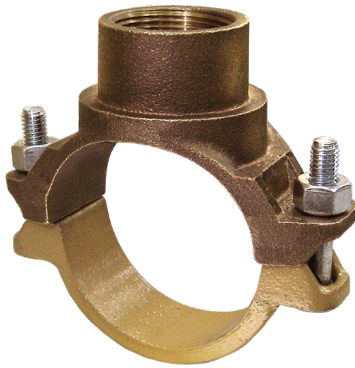

The Shurjoint Model C723 provides a fast, easy and reliable branch connection from copper tubing (CTS). The fitting consists of bronze upper housings, ductile iron lower housing, rubber gasket and carbon steel track bolts and nuts. The lead-free bronze castings conform to ASTM B-584 copper alloy C83470 (93-4-0-2) is available with a female threaded outlet, NPT or BSPT.



Use a torque wrench and tighten the nuts to an approx. torque value of 15 ~ 22 lb-ft (20 ~ 30 Nm). Excess torque may cause joint failure.

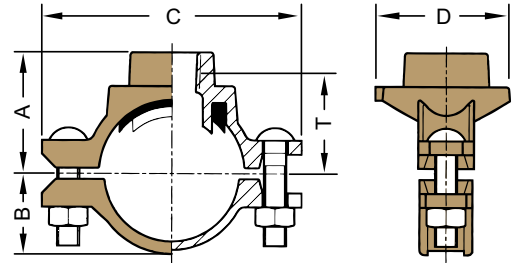

DIMENSIONS

NOMINAL CTS X NPT	MAX. WORKING PRESSURE (CWP)*	HOLE DIA. in +0.063/-0 mm +1.6/-0	DIMENSIONS					BOLT SIZE	WEIGHT
			A	B	C	D	T**		
in	PSI		in	in	in	in	in	in	lb
mm	Bar		mm	mm	mm	mm	mm	mm	kg
2-1/2 x 1/2	200	1.18	2.56	1.61	4.65	1.89	2.09	3/8 x 2-1/8	1.5
65 x 15	14	30	65	41	118	48	53	3/8 x 2-1/8	0.7
2-1/2 x 3/4	200	1.18	2.56	1.61	4.65	2.01	2.05	3/8 x 2-1/8	1.5
65 x 20	14	30	65	41	118	51	52	3/8 x 2-1/8	0.7
2-1/2 x 1	200	1.18	2.56	1.61	4.65	1.89	1.93	3/8 x 2-1/8	1.5
65 x 25	14	30	65	41	118	48	49	3/8 x 2-1/8	0.7
2-1/2 x 1-1/4	200	1.77	2.68	1.61	4.65	2.64	2.15	3/8 x 2-1/8	2.2
65 x 32	14	45	68	41	118	67	55	3/8 x 2-1/8	1.0
3 x 3/4	200	1.18	2.80	1.89	5.16	2.01	2.28	3/8 x 2-1/8	1.5
80 x 20	14	30	71	48	131	51	58	3/8 x 2-1/8	0.7
3 x 1	200	1.18	2.80	1.89	5.16	1.89	2.20	3/8 x 2-1/8	1.8
80 x 25	14	30	71	48	131	48	56	3/8 x 2-1/8	0.8
3 x 1-1/4	200	1.77	2.95	1.89	5.16	2.64	2.59	3/8 x 2-1/8	2.2
80 x 32	14	45	75	48	131	67	66	3/8 x 2-1/8	1.0
4 x 3/4	200	1.18	3.35	2.36	6.22	2.01	2.80	3/8 x 2-1/8	1.8
100 x 20	14	30	85	60	158	51	71	3/8 x 2-1/8	0.8
4 x 1	200	1.18	3.35	2.36	6.22	1.89	3.11	3/8 x 2-1/8	1.8
100 x 25	14	30	85	60	158	48	79	3/8 x 2-1/8	0.8
4 x 1-1/4	200	1.77	3.35	2.36	6.22	2.64	3.11	3/8 x 2-1/8	1.9
100 x 32	14	45	85	60	158	67	79	3/8 x 2-1/8	0.9

*Working pressure is for connection with Type K copper tubing.

**T: Center of run to engaged pipe end (approx.).

C726 Y-STRAINER FOR COPPER TUBING (CTS)



The Model C726 Grooved-end Y-Strainers are designed to strain debris and foreign matter from piping systems and thus provide inexpensive protection for costly pumps, meters and other components. The C726 Y-Strainer can be installed quickly and easily with two mechanical couplings and the straight flow through design provides for lower pressure drop. This strainer features a stainless steel screen that is secured with an end cap and mechanical coupling. Cleaning and maintenance of the screen can be accomplished easily by removing the coupling. The Model C726 Y-Strainer is suitable for vertical or horizontal installations.

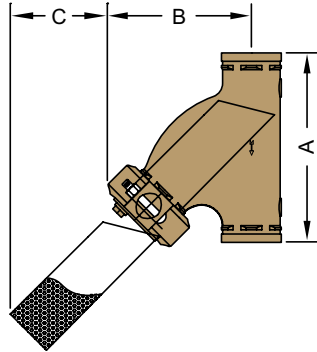

DIMENSIONS

NOMINAL SIZE	PIPE O.D.	MAX. WORKING PRESSURE (CWP)*	DIMENSIONS			DRAIN PLUG SIZE	WEIGHT
			A	B	C		
in	in	PSI	in	in	in	in	lb
mm	mm	Bar	mm	mm	mm	mm	kg
2	2.125	300	8.75	6.38	3.18	1/2	8.8
50	54.0	20	222	162	81	15	4.0
2-1/2	2.625	300	9.75	6.97	4.72	1/2	11.3
65	66.7	20	248	177	120	15	5.1
3	3.125	300	10.63	7.71	4.50	1/2	15.0
80	79.4	20	270	196	114	15	6.8
4	4.125	300	13.00	9.60	6.00	1	27.5
100	104.8	20	330	244	152	25	12.5
6	6.125	300	17.00	12.91	8.00	1	59.3
150	155.6	20	432	328	203	25	26.9

*Working pressure is for connection with Type K copper tubing.

SJ-C300 BUTTERFLY VALVE FOR COPPER TUBING (CTS)

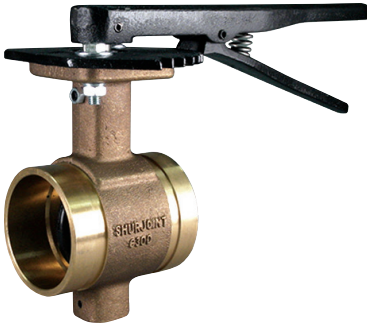

The Model SJ-C300 is a lever handle bronze body butterfly valve designed for use with grooved copper tubing (CTS), fittings and couplings. This valve features a 10 position locking lever handle and lead-free bronze body and EPDM rubber encapsulated dual-seal disc. The lead-free bronze body conforms to ASTM B-584 copper alloy C89836 Bismuth bronze. The EPDM rubber disc is classified in accordance with NSF/ANSI 61 and NSF/ANSI 372 for use in cold +86oF (+30oC) and hot +180oF (+82oC) potable water system. Also available with factory installed gear operator on request.

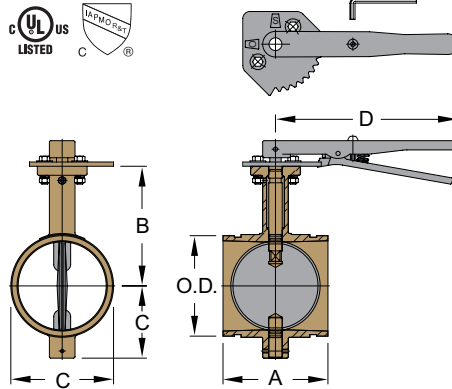

DIMENSIONS

NOMINAL SIZE	PIPE O.D.	MAX. WORKING PRESSURE (CWP)*	DIMENSIONS				WEIGHT
			A	B	C	D	
in	in	PSI	in	in	in	in	lb
mm	mm	Bar	mm	mm	mm	mm	kg
2	2.125	300	3.19	5.31	2.45	10.0	5.9
50	54	20	81	135	57	254	2.7
2-1/2	2.625	300	3.78	5.87	2.87	10.0	7.3
65	66.7	20	96	149	73	254	3.3
3	3.125	300	3.78	6.42	3.27	10.0	7.7
80	79.4	20	96	163	83	254	3.5
4	4.125	300	4.65	8.19	4.29	10.0	11.0
100	104.8	20	118	208	109	254	5.0
5	5.125	300	5.28	9.80	5.36	10.0	16.9
125	130.2	20	134	249	136	254	7.7
6	6.125	300	5.28	10.79	6.42	10.0	16.9
150	155.6	20	134	274	163	254	7.7

*Working pressure is for connection with roll-grooved Type K copper tubing.

** Please note that 2", 2-1/2", and 3" Model C341 Flanges cannot be used for making direct connections to Model SJ-C300 Butterfly Valves due to bolt pad interference with the valve.



**AWWA
ductile iron
series**

Shurjoint offers a variety of grooved mechanical couplings and fittings for AWWA ductile iron pipe in sizes 3" to 24". The Shurjoint coupling features a two-piece housing and GapSeal gasket for a leak-tight seal. Ductile iron pipe shall be cut-grooved to AWWA C606 Table 2 and Table 3 - Radius Cut Groove Specifications.

Rubber gaskets are specially compounded to seal on ductile iron surfaces and are available in three grades to meet your service requirement needs.

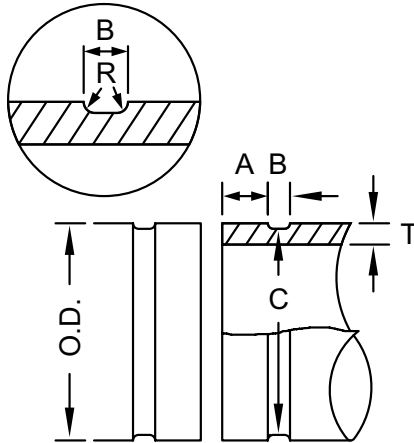

GASKET SEATING SURFACE (A):

The same coupling can be used either as a rigid joint or a flexible joint depending on the groove. Gasket seat "A Rigid" is for rigid joints and Gasket seat "A Flex." for flexible joints.

The gasket seating surface shall be free from deep scores, marks, or ridges that could prevent a positive seal.

GROOVE DIAMETER (C):

The "C" diameters are average values. The groove must be of uniform depth around the entire pipe circumference.

RADIUS (R):



The groove must be cut with a radius 'R' at the corners of the groove to reduce stress concentration.

MINIMUM WALL THICKNESS (T):

"T" is the minimum allowable wall thickness that may be cut-grooved; tolerances are to conform to ANSI/AWWA C151/ A21.51.

NOMINAL SIZE	PIPE O.D.			GASKET SEAT A		GROOVE WIDTH B +0.031/-0.016 +0.79/-0.41	GROOVE DIA. C		RADIUS R	MIN. ALLOWED WALL THICKNESS T
	BASIC	TOLERANCE		RIGID	FLEX.		BASIC	TOL. +0 +0		
		+	-	+0/-0.02 +0/-0.51	+0.016/-0.047 +0.41/-1.19	mm			mm	
3	3.96	+0.045	-0.045	0.840	0.750	0.375	3.723	-0.020	0.120	0.31
80	100.6	+1.14	-1.14	21.34	19.05	9.53	94.56	-0.51	3.05	7.9
4	4.80	+0.045	-0.045	0.840	0.750	0.375	4.563	-0.020	0.120	0.32
100	121.9	+1.14	-1.14	21.34	19.05	9.53	115.90	-0.51	3.05	8.1
6	6.90	+0.060	-0.060	0.840	0.750	0.375	6.656	-0.020	0.120	0.34
150	175.3	+1.52	-1.52	21.34	19.05	9.53	169.06	-0.51	3.05	8.6
8	9.05	+0.060	-0.060	0.840	0.875	0.500	8.781	-0.025	0.145	0.36
200	229.9	+1.52	-1.52	21.34	22.83	12.70	223.04	-0.64	3.68	9.1
10	11.10	+0.060	-0.060	1.015	0.938	0.500	10.813	-0.025	0.145	0.38
250	281.9	+1.52	-1.52	25.78	23.83	12.70	274.65	-0.64	3.68	9.7
12	13.20	+0.060	-0.060	1.015	0.938	0.500	12.906	-0.030	0.145	0.40
300	335.3	+1.52	-1.52	25.78	23.83	12.70	327.81	-0.76	3.68	10.2
14	15.30	+0.050	-0.080	1.015	0.938	0.625	14.969	-0.030	0.165	0.42
350	388.6	+1.27	-2.03	25.78	23.83	15.88	380.21	-0.76	4.19	10.7
16	17.40	+0.050	-0.080	1.340	1.188	0.625	17.063	-0.030	0.165	0.43
400	442.0	+1.27	-2.03	34.04	30.18	15.88	433.40	-0.76	4.19	10.9
18	19.50	+0.050	-0.080	1.340	1.188	0.625	19.125	-0.030	0.185	0.44
450	495.3	+1.27	-2.03	34.04	30.18	15.88	485.78	-0.76	4.70	11.2
20	21.60	+0.050	-0.080	1.340	1.188	0.625	21.219	-0.030	0.185	0.45
500	548.6	+1.27	-2.03	34.04	30.18	15.88	538.96	-0.76	4.70	11.4
24	25.80	+0.050	-0.080	1.340	1.188	0.625	25.046	-0.030	0.185	0.47
600	655.3	+1.27	-2.03	34.04	30.18	15.88	645.31	-0.76	4.70	11.9

SPECIAL GASKETS FOR AWWA DUCTILE IRON PIPE

GRADE	TEMP. RANGE	COMPOUND	COLOR CODE	GENERAL SERVICE RECOMMENDATIONS
S	-20°F to +180°F (-29°C to +82°C)	Nitrile	 Red Stripe	Specially formulated to seal on ductile iron pipe iron surfaces. Recommended for petroleum products, air with oil vapors, vegetable and mineral oils within the specified temperature range; except hot dry air over +140°F (60°C) and water over +150°F (65°C) Not Recommended for Hot Water Services.
M	-20°F to +200°F (-29°C to +93°C)	Halogenated Butyl	 Brown Stripe	Specially formulated to seal on ductile iron pipe surfaces. Recommended for water service plus a variety of dilute acids, oil-free air and other chemical services within the specified temperature range. The compound is UL classified per NSF/ANSI 61 and NSF/ANSI 372 for potable water applications. Not Recommended for Hot Water Services.
L	-30°F to +350°F (-34°C to +177°C)	Silicone	 Red Gasket	Recommended for dry heat, air without hydrocarbons to 350°F (177°C) and certain chemical services.



Shurjoint Model A505 Couplings are designed for connecting grooved ductile iron pipe and fittings of ANSI/AWWA C151/ A21.51, Class 53 or higher dimensions. The same coupling can be used either as a flexible coupling or a rigid coupling depending on the type of groove processed. The Model A505 Coupling is recommended for service up to 500 psi (35 Bar) depending on the size. The GapSeal gasket fits flush over the pipe ends and prevents fluids from entering into the gasket cavity.

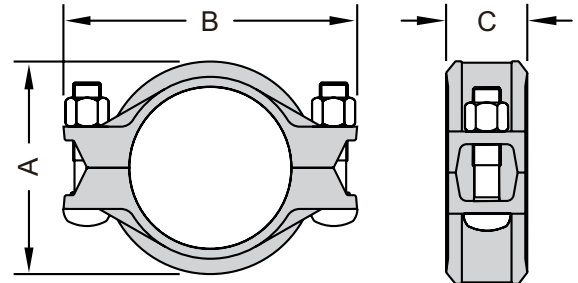
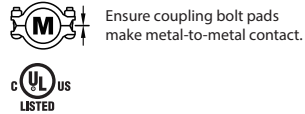

DIMENSIONS

AWWA D.I. PIPE		MAX. WORKING PRESSURE (CWP)*	MAX. END LOAD	AXIAL DISPLACEMENT †	BOLT		DIMENSIONS			WEIGHT
NOMINAL SIZE	PIPE O.D.				NO.	SIZE	A	B	C	
in	in	PSI	Lbs	in		in	in	in	lb	
mm	mm	Bar	kN	mm		mm	mm	mm	Kgskg	
3	3.96	500	6200	0~0.09	2	1/2 x 3	5.33	7.36	2.40	5.5
80	100.6	35	27.59	0~2.4			136	187	61	2.5
4	4.80	500	9000	0~0.09	2	5/8 x 3-1/2	6.96	8.33	2.32	7.3
100	121.9	35	40.50	0~2.4			157	212	59	3.3
6	6.90	400	14950	0~0.09	2	5/8 x 3-1/2	9.37	10.75	2.44	9.7
150	175.3	28	66.26	0~2.4			211	273	62	4.4
8	9.05	400	25600	0~0.16	2	3/4 x 4-3/4	12.07	13.94	2.64	18.7
200	229.9	28	113.92	0~4.0			272	354	67	8.5
10	11.10	350	33850	0~0.16	2	3/4 x 4-3/4	14.50	16.06	2.95	24.2
250	281.9	24	150.63	0~4.0			326	408	75	11.0
12	13.20	350	47900	0~0.16	2	7/8 x 6-1/2	16.89	18.19	2.95	30.8
300	335.3	24	211.50	0~4.0			380	462	75	14.0

* Pressure ratings listed are based on radius cut-grooved Thickness Class 53 or higher pipe.

** Non-standard/stock items may require longer lead time.

† Only when connected on flexible radius groove.



The Shurjoint Model A507 Transition Coupling provides for a direct connection between grooved end IPS steel pipe and grooved end AWWA ductile iron pipe, fittings and or valves. The A507 will accommodate roll or cut grooved IPS steel pipe and rigid or flexible AWWA ductile iron cut grooves.



Ensure coupling bolt pads make metal-to-metal contact.

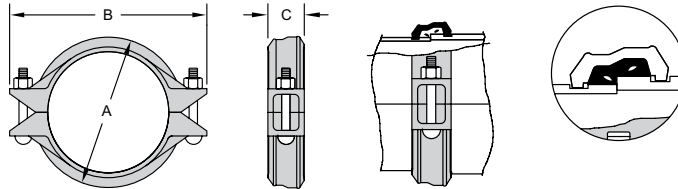

DIMENSIONS

NOMINAL SIZE	PIPE O.D.		MAX. WORKING PRESSURE (CWP)*	MAX. END LOAD	AXIAL DISPLACEMENT	BOLT SIZE	DIMENSIONS			WEIGHT
	IPS STEEL	AWWA DUCTILE IRON					A	B	C	
in	in	in	PSI	lb	in	in	in	in	in	lb
mm	mm	mm	Bar	kN	mm	mm	mm	mm	mm	kg
3	3.500	3.96	500	4810	0.03	1/2 x 2-3/4	5.31	7.28	2.13	4.8
80	88.9	100.6	35	21.41	1		135	185	54	2.2
4	4.500	4.80	500	7950	0.03	5/8 x 3-1/2	6.22	8.54	2.19	6.4
100	114.3	121.9	35	35.38	1		158	217	56	2.9
6	6.625	6.90	400	13780	0.03	5/8 x 3-1/2	8.23	10.75	2.19	8.6
150	168.3	175.3	28	61.32	1		209	273	56	3.9
8	8.625	9.05	400	23370	0.03	3/4 x 4-3/4	10.79	13.66	2.52	16.7
200	219.1	229.9	28	103.99	1		274	347	64	7.6
10	10.750	11.10	350	33850	0.03	7/8 x 6-1/2	13.03	16.10	2.76	24.9
250	273.0	281.9	24	155.96	1		331	409	70	11.3
12	12.750	13.20	350	47870	0.03	7/8 x 6-1/2	15.00	18.35	2.76	28.6
300	323.9	335.3	24	220.64	1		381	466	70	13.0

* Pressure ratings listed are based on radius cut-grooved Thickness Class 53 or higher pipe.
 ** Non-standard/stock items may require longer lead time.

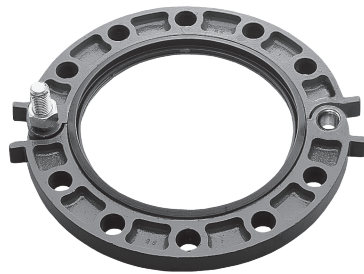

A512 FLANGE ADAPTER

The Shurjoint Model A512 Flange Adapter provides for the direct connection between AWWA ductile iron radius pipe grooves and flanged components. The two part flange features integral closure tabs to aid in assembly. Note: As with other flange adapters the A512 requires a sufficient smooth flat mating area for proper sealing, please refer to the A512 cut sheet or contact Shurjoint for details.

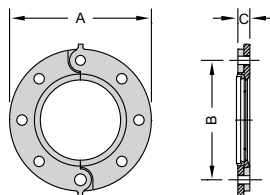

DIMENSIONS

AWWA D.I. PIPE		MAX. WORKING PRESSURE (CWP)*	MAX. END LOAD	BOLT		DIMENSIONS			WEIGHT
NOMINAL SIZE	PIPE O.D.			NO.	SIZE	A	B	C	
in	in	PSI	lb		in	in	in	in	lb
mm	mm	Bar	kN		mm	mm	mm	mm	kg
3	3.96	250	3100	4	5/8 x 3	7.50	6.00	1.10	8.6
80	100.6	17	13.80			190	152	28	3.9
4	4.80	250	4500	8	5/8 x 3	9.00	7.50	1.10	9.9
100	121.9	17	20.03			229	191	28	4.5
6	6.90	250	9300	8	3/4 x 3-1/2	11.00	9.49	1.10	12.0
150	175.3	17	41.39			279	241	28	5.4
8	9.05	250	16000	8	3/4 x 3-1/2	13.50	11.75	1.22	18.9
200	229.9	17	71.20			343	298	31	8.6
10	11.10	250	23700	12	7/8 x 4	16.00	14.25	1.26	25.3
250	281.9	17	105.47			406	362	32	11.5
12	13.20	250	34000	12	7/8 x 4	19.00	17.00	1.26	34.4
300	335.3	17	151.30			483	432	32	15.6

* Pressure ratings listed are based on radius cut-grooved Thickness Class 53 or higher pipe.
 ** Flange drilling to ANSI B16.1 Class 125.
 *** Non-standard/stock items may require longer lead time
 Specified bolt torque is required for flange connection. See page 133 in the Shurjoint Installation Instructions..

AWWA GROOVED FITTINGS

A10 90° Elbow A20 Tee
 A11 45° Elbow A60 Cap



Shurjoint AWWA grooved end fittings are supplied with rigid radius grooves as per ANSI / AWWA C606. The fittings also conform to ANSI A21.10 / AWWA C110 for center to end (C to E) dimensions and AWWA C153 or ANSI A21.10 / AWWA C110 for wall thickness. Pressure ratings are 500 psi (35 Bar). Fittings are supplied painted black. Other surface finish options including 'non-coated' and cement/mortar lining Type II are available on request.

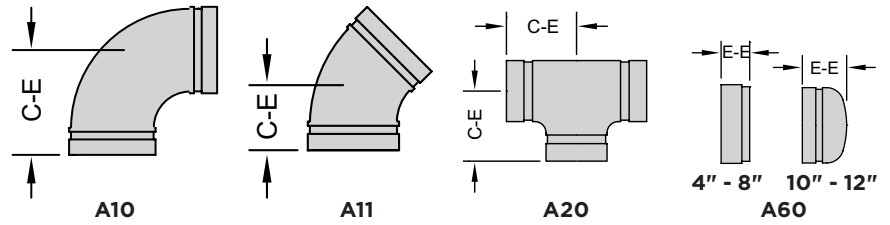

DIMENSIONS

AWWA D.I. PIPE		A10 90° ELBOW		A11 45° ELBOW		A20 TEE		A60 CAP	
NOM. SIZE	O.D.	C - E	WEIGHT	C - E	WEIGHT	C - E	WEIGHT	E - E	WEIGHT
in	in	in	lb	in	lb	in	lb	in	lb
mm	mm	mm	kg	mm	kg	mm	kg	mm	kg
3	3.96	5.50	9.2	3.00	5.8	5.50	13.4	1.22	2.6
80	100.6	140	4.2	76	2.6	140	6.1	31	1.2
4	4.80	6.50	12.3	4.00	9.2	6.50	18.5	1.22	3.5
100	121.9	165	5.6	102	4.2	165	8.4	31	1.6
6	6.90	8.00	23.5	5.00	17.6	8.00	35.0	1.22	6.8
150	175.3	203	10.7	127	8.0	203	15.9	31	3.1
8	9.05	9.00	41.6	5.50	33.0	9.00	60.3	1.46	13.0
200	229.9	229	18.9	140	15.0	229	27.4	37	5.9
10	11.10	11.00	64.9	6.50	44.9	11.00	110.5	2.99	22.0
250	281.9	279	29.5	165	20.4	279	45.7	76	10.0
12	13.20	12.00	94.2	7.50	72.0	12.00	136.0	2.99	24.6
300	335.3	305	42.8	191	32.7	305	61.7	76	11.2

* Non-standard/stock items may require longer lead time.

AWWA GROOVED FITTINGS

- A25 Reducing tee
- A50 Concentric reducer
- A10r Reducing elbow

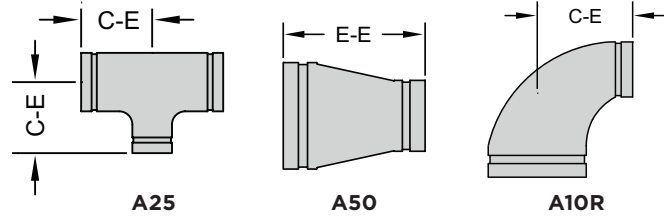

DIMENSIONS

AWWA D.I. PIPE		A25 REDUCING TEE		A50 CONCENTRIC REDUCER		A10R 90° REDUCING ELBOW	
NOM. SIZE	O.D.	C - E	WEIGHT	E - E	WEIGHT	C - E	WEIGHT
in	in	in	lb	in	lb	in	lb
mm	mm	mm	kg	mm	kg	mm	kg
4 x 3	4.80 x 3.96	6.50	18.8	7.00	7.7	6.50	12.1
100 x 80	121.9 x 100.6	165	8.5	178	3.5	165	5.5
6 x 4	6.90 x 4.80	8.00	33.3	9.00	14.3	8.00	25.1
150 x 100	175.3 x 121.9	203	15.2	229	6.5	203	11.4
8 x 4	9.05 x 4.80	9.00	51.2	11.00	24.0	9.00	43.5
200 x 100	229.9 x 121.9	229	23.3	279	10.9	229	19.8
8 x 6	9.05 x 6.90	9.00	57.2	11.00	24.0	9.00	41.8
200 x 150	229.9 x 175.3	229	26.0	279	12.6	229	19.0
10 x 4	11.10 x 4.80	11.00*	120.0	12.00*	42.0	-	-
250 x 100	281.9 x 121.9	279	54.4	305	19.1	-	-
10 x 6	11.10 x 6.90	11.00	128.0	12.00	46.0	11.00	77.0
250 x 150	281.9 x 175.3	279	58.1	305	20.9	279	34.9
10 x 8	11.10 x 9.05	11.00	130.0	12.00	50.0	11.00	88.0
250 x 200	281.9 x 229.9	279	59.0	305	22.7	279	39.9
12 x 4	13.20 x 4.80	12.00*	112.0	14.00*	60.0	-	-
300 x 100	335.3 x 121.9	305	50.8	356	27.2	-	-
12 x 6	13.20 x 6.90	12.00*	180.0	14.00*	70.0	12.00*	110.0
300 x 150	335.3 x 175.3	305	81.7	356	31.8	305	49.9
12 x 8	13.20 x 9.05	12.00*	186.0	14.00*	74.0	12.00*	126.0
300 x 200	335.3 x 229.9	305	84.4	356	33.6	305	57.2
12 x 10	13.20 x 11.10	12.00*	192.0	14.00	84.0	12.00*	150.0
300 x 250	335.3 x 281.9	305	87.1	356	38.1	305	68.0

Non-standard/stock items may require longer lead time.



**technical
information**

Shurjoint grooved piping systems require the processing of a roll or cut groove to the pipe ends being connected. The engagement of the housing keys in the grooves is integral in providing a secure and leak-tight joint. It is essential that the grooves are properly processed for optimum joint performance.

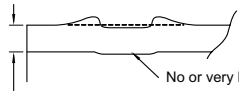
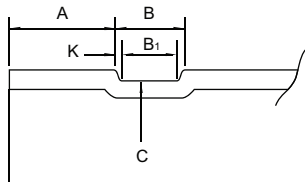
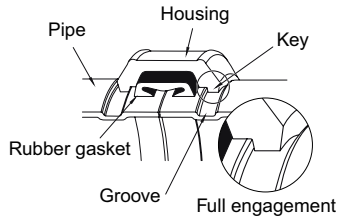

Thicker than 0.375" (9.5mm)



NOMINAL PIPE SIZE

Shurjoint couplings and fittings are identified by the nominal IPS pipe size in inches or nominal diameter of pipe (DN) in millimeters. Always check the actual O.D. of the pipe and fittings to be connected, as in some markets it is customary to refer to different O.D. pipes with the same nominal size.

ROLL GROOVE PROFILE

Roll grooves should be as defined as possible. To achieve optimum joint performance the "K" dimension should be as small as possible. When processing a roll groove the machine operator should manage the feed pressure of the upper roll set so as to achieve the best possible groove profile. Stainless steel pipes and copper tube require specified rollers designed to provide proper dimensions and profiles. These shall be used when grooving these materials.

APPLICABLE PIPE WALL THICKNESS

Roll grooves are generally applicable to .375"/9.5 mm thick or thinner wall carbon steel pipe, stainless steel pipe, copper tube and aluminum pipe depending on the type of roll-grooving machine and roll set being used. Different wall thicknesses and sizes require the use of different roll sets. Contact the roll groove machine manufacturer for additional information.

HEAVY WALL PIPE

When you attempt to roll-groove pipe thicker than .375"/9.5mm, the metal may deform and heap up on both sides of the groove rather than radially deforming and protruding on the inside of the pipe, which could lead to joint failure. Pipes of a thickness greater than 0.375", will require cut grooving to achieve a proper groove profile.

PLAIN END PIPE AND BEVELED END PIPE

While plain-end pipe is preferred, the use of beveled end pipe is acceptable providing that the wall thickness is .375"/9.5 mm or thinner and the bevel is $37\frac{1}{2} \pm 2-1/2$ or 30° as specified in ANSI B16.25 and ASTM A-53 respectively.

ERW PIPE

ERW pipe is one of the most popular types of pipe used today. Depending on the individual pipe and manufacturer, welding beads may remain on the surface (inside and outside) of the pipe. Always remove harmful weld beads near the pipe ends as they can cause rattling of the roll grooving machine resulting in inaccurate grooves. Any raised weld on the sealing surface, "A" dimension, may cause a leak path below the gasket lip. This would require removal to achieve a good seal.

GALVANIZED PIPE

Galvanized pipe is acceptable as long as the gasket seating surface is smooth and free from scale and imperfections that could affect gasket sealing. Whenever you remove welding beads or projections from the sealing surface of galvanized pipe, use caution so as to not over-grind the surface. After grinding, always apply a proper rust-prevention coating to this area.

SPIRAL WELDED PIPE

Spiral welded pipe may be used as long as the weld beads are removed from the gasket seating surface. It is also acceptable and recommended to weld a grooved end nipple to the pipe end as shown below. Whenever you remove weld beads or projections from the gasket seating surface, use caution so as to not over-grind the surface. After grinding, always apply a proper rust-prevention coating to this area.

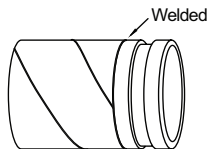

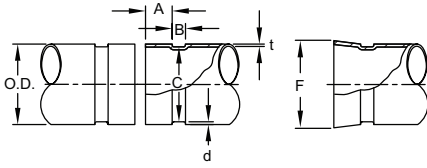

Basic roll groove dimensions conform to ANSI/AWWA C606-06 Table 5 with slightly adjusted tolerances to incorporate international standards including CSA B242, ISO/FDIS 6152-12, VdS 2100-6en and JPF MP-006.

ROLL GROOVING DIMENSIONS

ANSI B36.10, BS 1387 (M) & AS-1074 (M) PIPE

NOMINAL SIZE	PIPE O.D.			A ±0.030 ±0.76	B ±0.030 ±0.76	C +0.000 +0.00	MIN. WALL T	D GROOVE DEPTH D (REF.)	F MAX. ALLOWED FLARE DIA.
	BASIC	TOLERANCE							
in mm	in mm	in mm	in mm	in mm	in mm	in mm	in mm	in mm	in mm
3/4	1.050	+0.010	-0.010	0.625	0.281	0.938-0.015	0.065	0.056	1.15
20	26.7	+0.25	-0.25	15.88	7.14	23.83-0.38	1.65	1.42	29.21
1	1.315	+0.013	-0.013	0.625	0.281	1.190-0.015	0.065	0.063	1.43
25	33.4	+0.33	-0.33	15.88	7.14	30.23-0.38	1.65	1.60	36.30
1-1/4	1.660	+0.016	-0.016	0.625	0.281	1.535-0.015	0.065	0.063	1.77
32	42.2	+0.41	-0.41	15.88	7.14	38.99-0.38	1.65	1.60	44.96
1-1/2	1.900	+0.019	-0.019	0.625	0.281	1.775-0.015	0.065	0.063	2.01
40	48.3	+0.48	-0.48	15.88	7.14	45.09-0.38	1.65	1.60	51.05
2	2.375	+0.024	-0.024	0.625	0.344	2.250-0.015	0.065	0.063	2.48
50	60.3	+0.61	-0.61	15.88	8.74	57.15-0.38	1.65	1.60	62.99
2-1/2	2.875	+0.029	-0.029	0.625	0.344	2.720-0.018	0.083	0.078	2.98
65	73.0	+0.74	-0.74	15.88	8.74	69.09-0.46	2.11	1.98	75.69
3	3.500	+0.035	-0.031	0.625	0.344	3.344-0.018	0.083	0.078	3.60
80	88.9	+0.89	-0.79	15.88	8.74	84.94-0.46	2.11	1.98	91.44
4	4.500	+0.040	-0.031	0.625	0.344	4.334-0.020	0.083	0.083	4.60
100	114.3	+1.02	-0.79	15.88	8.74	110.08-0.51	2.11	2.11	116.84
5	5.563	+0.056	-0.031	0.625	0.344	5.395-0.022	0.109	0.083	5.66
125	141.3	+1.42	-0.79	15.88	8.74	137.03-0.56	2.77	2.11	143.76
6	6.625	+0.063	-0.031	0.625	0.344	6.455-0.022	0.109	0.085	6.73
150	168.3	+1.60	-0.79	15.88	8.74	163.96-0.56	2.77	2.16	170.94
8	8.625	+0.063	-0.031	0.750	0.469	8.441-0.025	0.109	0.092	8.80
200	219.1	+1.60	-0.79	19.05	11.91	214.40-0.64	2.77	2.34	223.52
10	10.750	+0.063	-0.031	0.750	0.469	10.562-0.027	0.134	0.094	10.92
250	273.0	+1.60	-0.79	19.05	11.91	268.27-0.69	3.40	2.39	277.37
12	12.750	+0.063	-0.031	0.750	0.469	12.531-0.030	0.156	0.109	12.92
300	323.9	+1.60	-0.79	19.05	11.91	318.29-0.76	3.96	2.77	328.17
14	14.000	+0.063	-0.031	0.938	0.469	13.781-0.030	0.156	0.109	14.10
350	355.6	+1.60	-0.79	23.83	11.91	350.04-0.76	3.96	2.77	358.14
16	16.000	+0.063	-0.031	0.938	0.469	15.781-0.030	0.165	0.109	16.10
400	406.4	+1.60	-0.79	23.83	11.91	400.84-0.76	4.19	2.77	408.94
18	18.000	+0.063	-0.031	1.000	0.469	17.781-0.030	0.165	0.109	18.16
450	457.2	+1.60	-0.79	25.40	11.91	451.64-0.76	4.19	2.77	461.26
20	20.000	+0.063	-0.031	1.000	0.469	19.781-0.030	0.188	0.109	20.16
500	508.0	+1.60	-0.79	25.40	11.91	502.44-0.76	4.78	2.77	512.06
22	22.000	+0.063	-0.031	1.000	0.469	21.656-0.030	0.188	0.172	22.20
550	558.8	+1.60	-0.79	25.40	11.91	550.06-0.76	4.78	4.37	563.88
24	24.000	+0.063	-0.031	1.000	0.500	23.656-0.030	0.218	0.172	24.20
600	609.6	+1.60	-0.79	25.40	12.70	600.86-0.76	5.54	4.37	614.68

1. Pipe O.D.: Maximum allowable tolerances from square cut ends is 0.03" for sizes up to 3-1/2"; 0.045" for 4" thru 6"; and 0.060" for sizes 8" and above.
2. The gasket seating surface "A" shall be free from deep scores, marks, or ridges that would prevent a positive seal.
3. The "C" dimensions are average values. The groove must be of uniform depth around the entire circumference. Use a Shurjoint groove gage or rule to check the groove diameter.
4. The "t" is the minimum allowable wall thickness that may be roll-grooved.
5. The "d" is for reference use only. The groove depth shall be determined by the groove diameter "C".
6. Flare Diameter: The pipe end that may flare when the groove is rolled shall be within this limit when measured at the extreme end of the pipe.

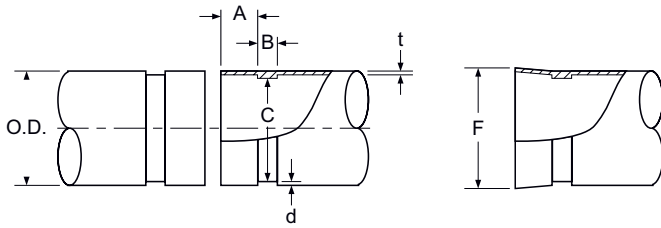

ROLL GROOVING DIMENSIONS LARGE DIAMETER IPS PIPE ANSI B36.10

NOMINAL SIZE	PIPE O.D.			A ±0.03 ±0.8	B ±0.03 ±0.8	C +0, -0.063 +0, -1.6	D GROOVE DEPTH (REF)	T MIN WALL	F MAX. ALLOWED FLARE DIA.
	BASIC	TOLERANCE							
in	in	in	in	in	in	in	in	in	in
mm	mm	mm	mm	mm	mm	mm	mm	mm	mm
26	26.0	+0.093	-0.031	1.75	0.625	25.5	0.25	0.25	26.2
650	660.4	+2.36	-0.79	44.5	15.9	647.7	6.4	6.4	665.5
28	28.0	+0.093	-0.031	1.75	0.625	27.5	0.25	0.25	28.2
700	711.2	+2.36	-0.79	44.5	15.9	698.5	6.4	6.4	716.3
30	30.0	+0.093	-0.031	1.75	0.625	29.5	0.25	0.25	30.2
750	762.0	+2.36	-0.79	44.5	15.9	749.3	6.4	6.4	767.1
32	32.0	+0.093	-0.031	1.75	0.625	31.5	0.25	0.25	32.2
800	812.8	+2.36	-0.79	44.5	15.9	800.1	6.4	6.4	817.9
36	36.0	+0.093	-0.031	1.75	0.625	35.5	0.25	0.25	36.2
900	914.4	+2.36	-0.79	44.5	15.9	901.7	6.4	6.4	919.5
40	40.0	+0.093	-0.031	2.00	0.625	39.5	0.25	0.25	40.4
1000	1016.0	+2.36	-0.79	50.8	15.9	1003.3	6.4	6.4	1026.2
42	42.0	+0.093	-0.031	2.00	0.625	41.5	0.25	0.25	42.2
1050	1066.8	+2.36	-0.79	50.8	15.9	1054.1	6.4	6.4	1071.9

1. Square cut: Max. allowable tolerances from square cut are 0.060" (1.6 mm).
2. The gasket seating surface "A" shall be free from deep scores, marks, or ridges that would prevent a positive seal.
3. The "C" dimensions are average values. The groove must be of uniform depth around the entire circumference. Use a Shurjoint groove or rule to check the groove diameter.
4. The "t" is the minimum allowable wall thickness that may be roll-grooved.
5. The "d" is for reference use only. The groove depth shall be determined by the groove diameter "C".
6. Flare Diameter: The pipe end that may flare when the groove is rolled shall be within this limit when measured at the extreme end of the pipe.

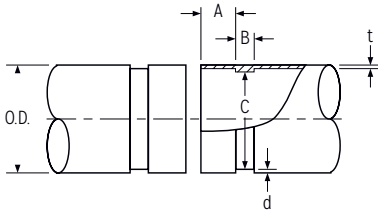

CUT GROOVING DIMENSIONS IPS, BS, AS, ISO, JIS & KS PIPE

NOMINAL SIZE	PIPE O.D.			A ±0.031 ±0.79	B ±0.031 ±0.79	C +0.000 +0.00	T MIN. WALL	D GROOVE DEPTH (REF.)
	BASIC	TOLERANCE						
in mm	in mm	in mm	in mm	in mm	in mm	in mm	in mm	in mm
3/4	1.050	+0.010	-0.010	0.625	0.313	0.938-0.015	0.113	0.056
20	26.7	+0.25	-0.25	15.88	7.95	23.83-0.38	2.87	1.42
1	1.315	+0.013	-0.013	0.625	0.313	1.190-0.015	0.133	0.063
25	33.4	+0.33	-0.33	15.88	7.95	30.23-0.38	3.38	1.60
1-1/4	1.660	+0.016	-0.016	0.625	0.313	1.535-0.015	0.140	0.063
32	42.2	+0.41	-0.41	15.88	7.95	38.99-0.38	3.56	1.60
1-1/2	1.900	+0.019	-0.019	0.625	0.313	1.775-0.015	0.145	0.063
40	48.3	+0.48	-0.48	15.88	7.95	45.09-0.38	3.68	1.60
2	2.375	+0.024	-0.024	0.625	0.313	2.250-0.015	0.154	0.063
50	60.3	+0.61	-0.61	15.88	7.95	57.15-0.38	3.91	1.60
2-1/2	2.875	+0.029	-0.029	0.625	0.313	2.720-0.018	0.188	0.078
65	73.0	+0.74	-0.74	15.88	7.95	69.09-0.46	4.78	1.98
3	3.500	+0.035	-0.031	0.625	0.313	3.344-0.018	0.188	0.078
80	88.9	+0.89	-0.79	15.88	7.95	84.94-0.46	4.78	1.98
4	4.250	+0.043	-0.031	0.625	0.375	4.084-0.020	0.203	0.083
100	108.0	+1.04	-0.79	15.88	9.53	103.73-0.51	5.16	2.11
4	4.500	+0.045	-0.031	0.625	0.375	4.334-0.020	0.203	0.083
100	114.3	+1.14	-0.79	15.88	9.53	110.08-0.51	5.16	2.11
5	5.563	+0.056	-0.031	0.625	0.375	5.395-0.022	0.203	0.083
125	141.3	+1.42	-0.79	15.88	9.53	137.03-0.56	5.16	2.11
6	6.625	+0.063	-0.031	0.625	0.375	6.455-0.022	0.219	0.085
150	168.3	+1.60	-0.79	15.88	9.53	163.96-0.56	5.56	2.16
8	8.625	+0.063	-0.031	0.750	0.438	8.441-0.025	0.238	0.092
200	219.1	+1.60	-0.79	19.05	11.13	214.40-0.64	6.05	2.34
10	10.750	+0.063	-0.031	0.750	0.500	10.562-0.027	0.250	0.094
250	273.0	+1.60	-0.79	19.05	12.70	268.27-0.69	6.35	2.39
12	12.750	+0.063	-0.031	0.750	0.500	12.531-0.030	0.279	0.109
300	323.9	+1.60	-0.79	19.05	12.70	318.29-0.76	7.09	2.77
14	14.000	+0.063	-0.031	0.938	0.500	13.781-0.030	0.281	0.109
350	355.6	+1.60	-0.79	23.83	12.70	350.04-0.76	7.14	2.77
16	16.000	+0.063	-0.031	0.938	0.500	15.781-0.030	0.312	0.109
400	406.4	+1.60	-0.79	23.83	12.70	400.84-0.76	7.92	2.77
18	18.000	+0.063	-0.031	1.000	0.500	17.781-0.030	0.312	0.109
450	457.2	+1.60	-0.79	25.40	12.70	451.64-0.76	7.92	2.77
20	20.000	+0.063	-0.031	1.000	0.500	19.781-0.030	0.312	0.109
500	508.0	+1.60	-0.79	25.40	12.70	502.44-0.76	7.92	2.77
22	22.000	+0.063	-0.031	1.000	0.563	21.656-0.030	0.375	0.172
550	558.8	+1.60	-0.79	25.40	14.30	550.06-0.76	9.53	4.37
24	24.000	+0.063	-0.031	1.000	0.563	23.656-0.030	0.375	0.172
600	609.6	+1.60	-0.79	25.40	14.30	600.86-0.76	9.53	4.37

1. Pipe OD: Maximum allowable tolerances from square of ends is 0.03" for sizes up to 3-1/2"; 0.045" for 4" thru 6"; and 0.060" for sizes 8" and above.
2. Gasket Seating Surface: The gasket seating surface shall be free from deep scores, marks, or ridges that would prevent a positive seal.
3. Groove Width: Groove width is to be measured between vertical flanks of the groove side walls.
4. Groove Diameter: The "C" diameters are average values. The groove must be of uniform depth around the entire pipe circumference.
5. Minimum Wall Thickness: The "t" is the minimum allowable wall thickness that may be cut-grooved.
6. Groove Depth: The "d" is for reference use only. The groove dimension shall be determined by the groove diameter "C".

1. ABSORPTION OF VIBRATION AND NOISE

When a pump operates with frequent starts and stops, the piping system is affected by the noise and vibration of the equipment. The entire system may develop a large sway, referred to as sympathetic vibration, as a result of the frequent cycling. Shurjoint flexible couplings will help reduce such vibration and noise. The system should always be properly designed with steel angle sway braces to protect the system from large sways.

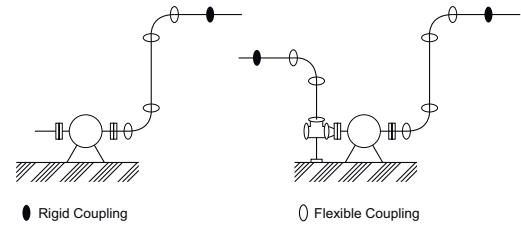

2. ADJUSTMENT OF MISALIGNMENT

When a straight run has need for a slight adjustment of alignment on the jobsite as shown in the diagram, you can accomplish this with the use of two flexible couplings. The following table shows the deflection value (θ) of the Shurjoint 7705 flexible couplings.

AMOUNT OF DEFLECTION (δ)

NOMINAL SIZE	DEFLECTION ANGLE (°)	DISTANCE BETWEEN COUPLINGS (L)					
		in	23.6	47.2	59.0	78.7	118.1
in	Degree - Min	in	23.6	47.2	59.0	78.7	118.1
mm		mm	600	1200	1500	2000	3000
2	3° - 02'	in	1.3	2.5	3.1	4.2	6.3
50		mm	32	64	79	106	159
2-1/2	2° - 30'	in	1.0	2.0	2.6	3.4	5.2
65		mm	26	52	65	87	131
3	2° - 04'	in	0.9	1.7	2.1	2.8	4.3
80		mm	22	43	54	72	108
4	3° - 12'	in	1.3	2.6	3.3	4.4	6.6
100		mm	34	67	84	112	168
5	2° - 36'	in	1.1	2.1	2.7	2.4	5.4
125		mm	27	54	68	61	136
6	1° - 10'	in	0.5	0.9	1.2	1.6	2.4
150		mm	12	24	31	41	61
8	1° - 40'	in	0.7	1.4	1.7	2.3	3.4
200		mm	17	35	44	58	87
10	1° - 20'	in	0.6	1.1	1.4	1.9	2.8
250		mm	14	28	35	47	70
12	1° - 08'	in	0.5	0.9	1.2	1.6	2.3
300		mm	12	24	30	40	59

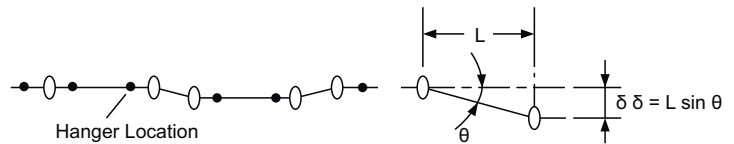

3. ABSORPTION OF DISTORTION

With the use of an assembly as shown below, ground sinking or movement around a tank or reservoir can be effectively absorbed, avoiding damage to the tank, reservoir and or the piping system.

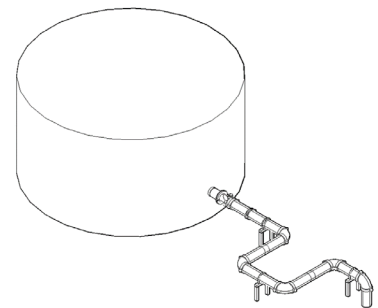

4. ABSORPTION OF INTER-FLOOR DEFLECTION

Risers of high-rise flexible structure buildings are subjected to lateral sways (inter-floor deflection) when an earthquake occurs. If we assume the inter-floor deflection is 1/150 and the floor height (H) as 4 meters, the estimated inter-floor deflection (α) will be:

$$\alpha = H \times 1/150 = 4000 \times 1/150 = 27 \text{ mm}$$

If we use a 200 mm (8") 7707 coupling for each floor, the maximum deflection (β) that each coupling can accommodate will be;

$$\beta = L \times \tan \theta = 4000 \times 0.02915 = 4.56'' = 116 \text{ mm } (\theta = 1.67^\circ)$$

The example shows a flexible coupling would be sufficient to absorb this scale of seismic sways.

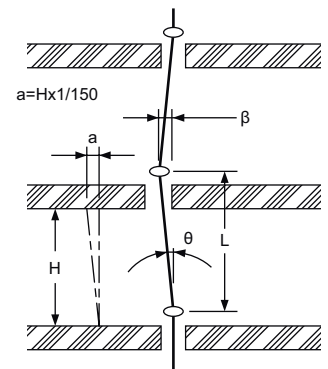

5. ABSORPTION OF MISALIGNMENT

As shown in the diagram, each branch connection to the free riser will be subjected to serious shearing forces as pressure thrusts or thermal movement increases. By using two flexible couplings, you can solve this problem.

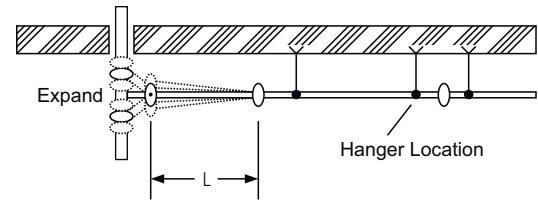

6. CURVED LAYOUT

With Shurjoint flexible couplings you can design a slowly curved layout for a system along a curved tunnel, winding road or curved building.

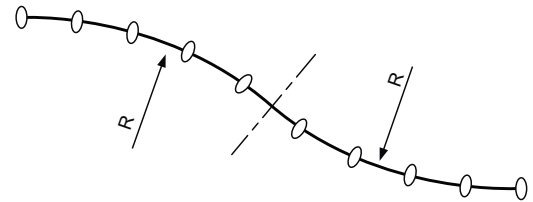

$$R = \frac{L}{2 \times \tan \theta/2}$$

(where: R is radius of curvature, L is pipe length, and θ is max. allowed deflection of a coupling)

Example: When using model 7705 100 mm (4") couplings for the layout as shown in the diagram, the max. allowed deflection (θ) of the coupling is 3.4°, and the pipe length (L) is 5.5 meters, the radius of curvature (R) will be 92.7 meters.

7. ABSORPTION OF THERMAL STRESS

Thermal stress is caused by changes in temperature, resulting in either expansion or contraction. With the use of Shurjoint flexible couplings you can design your system to accommodate such movement without the need for costly expansion joints.

The thermal expansion or contraction (μ) is determined by the length of pipe (L) and temperature difference (ΔT).
 $\mu = \alpha \times L \times \Delta T$

As the linear expansion coefficient for steel (α) is 1.2×10^{-5} , you can use the table to the right to determine the thermal expansion.

Example:

- Pipe size: 100 mm (4")
- Max. pipe end separation (E): 3.2 mm
- Pipe length (L): 5500 mm
- Temperature difference (ΔT): 40° C (+5° C to +45° C)
- $\alpha = 1.2 \times 10^{-5} / ^\circ \text{C}$

$$\mu = \alpha \times L \times \Delta T = 1.2 \times 10^{-5} / ^\circ \text{C} \times 5500 \text{ mm} \times 40^\circ \text{C} = 2.64 \text{ mm}$$

The thermal expansion of a 5.5 meter standard length of pipe (μ) is within the allowance (= max. pipe end separation) of a flexible coupling. In other words, if you use a coupling for each pipe length of 5.5 meters, the coupling will accommodate the thermal expansion or contraction expected to take place for a 40° C temperature change. When you calculate the necessary number of couplings (N) for an anchored system, you should place a clearance of $N \times E \times 1/2$ as a safety factor.

Whether it is thermal expansion, contraction, or a combination thereof, the system requires suitable anchor installations with properly space alignment guides and weight support devices. Where and when larger thermal movement is anticipated, you should use supplementary expansion joint(s).

THERMAL EXPANSION

METRIC

TEMPERATURE DIFFERENCE ΔT (°C)	PIPE LENGTH L (M)					
	1	5.5*	10	20	30	40
1	0.012	0.07	0.12	0.24	0.36	0.48
5	0.06	0.33	0.6	1.2	1.8	2.4
10	0.12	0.66	1.2	2.4	3.6	4.8
20	0.24	1.3	2.4	4.8	7.2	9.6
30	0.36	2	3.6	7.2	11	15
40	0.48	2.6	4.8	9.6	14	20
50	0.6	3.3	6	12	18	24
60	0.72	4	7.2	14	22	29
70	0.84	4.6	8.4	17	25	34
80	0.96	5.3	9.6	19	29	39

* 5.5 meters is the standard length of commercial carbon steel pipe.

THERMAL EXPANSION

STANDARD

TEMPERATURE (°F)	PIPE LENGTH L (FT)			
	20	40	60	100
	THERMAL EXPANSION BETWEEN 70° F AND INDICATED TEMPERATURE (IN)			
0	-0.10	-0.20	-0.29	-0.49
25	-0.06	-0.13	-0.19	-0.32
50	-0.03	-0.06	-0.08	-0.14
70	0	0	0	0
100	0.05	0.09	0.14	0.23
125	0.08	0.17	0.25	0.42
150	0.12	0.24	0.37	0.61
175	0.16	0.32	0.48	0.80
200	0.20	0.40	0.59	0.99
225	0.24	0.48	0.73	1.21

* Coefficient of thermal expansion of steel pipe = 6.33 in/in, °F x 10⁻⁶

Shurjoint grooved couplings are designed to hold axial thrusts 3 to 5 times their rated working pressure, depending on the system standards; though the strength against bending movements is less than that of steel pipe. The joint may be damaged when a bending movement greater than the allowed deflection occurs. System designers shall provide anchors (main and intermediate) and pipe guides with proper spacing to protect the system from unexpected large bending movements.

These illustrations are examples only, and are not intended to be used for all installations as conditions and requirements vary from job to job. Reliance on general data or information contained herein shall be at the user's sole risk and without obligation to Shurjoint. Hangers shall be designed to support five times the weight of water-filled pipe plus 250 lb (115 kgs) at each point of pipe support (NFPA 13 9.1.1.1). The following illustrations are examples of acceptable hanger types and sizes per NFPA 13.

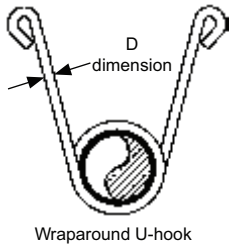

Wraparound U-hook

U-HOOK SIZES

PIPE SIZE	DIMENSION
	D
in	in
	mm
≤ 2	5/16
	7.9
2-1/2 - 6	3/8
	9.5
8	1/2
	12.7



Adjustable swivel Ring - rod tight to pipe

ROD SIZES

PIPE SIZE	DIMENSION
	D
in	in
	mm
≤ 4	3/8
	9.5
5 - 8	1/2
	12.7
10 - 12	5/8
	15.9



Eye rod hanger

EYE ROD SIZES

PIPE SIZE	DIMENSION
	D
in	in
	mm
≤ 4	3/8
	9.5
5 - 6	1/2
	12.7
10 - 12	3/4
	15.1

HANGERS FOR STRAIGHT RUNS

For straight runs, you can use both flexible and rigid couplings. When rigid couplings are used, the same hanger spacing as other piping methods can be applied. You can refer to the hanger spacing standards of ANSI B31.1 Power Piping Code, B31.9 Building Services Piping Code, NFPA 13 Sprinkler Systems, or Mechanical Equipment Construction Guide (Japan). See the table to the right.

SUGGESTED MAX. SPAN BETWEEN SUPPORTS STEEL PIPE

NOMINAL PIPE SIZE	WATER SERVICE (FEET / METERS)				GAS OR AIR SERVICE (FEET / METERS)		
	1)	2)	3)	4)	1)	2)	3)
1 / 25	7 / 2.1	9 / 2.7	12 / 3.7	6.6 / 2.0	9 / 2.7	10 / 3.0	12 / 3.7
1-1/4 / 32	7 / 2.1	11 / 3.4	12 / 3.7	6.6 / 2.0	9 / 2.7	12 / 3.7	12 / 3.7
1-1/2 / 40	7 / 2.1	12 / 3.7	15 / 4.6	6.6 / 2.0	9 / 2.7	13 / 4.0	15 / 4.6
2 / 50	10 / 3.0	13 / 4.0	15 / 4.6	6.6 / 2.0	13 / 4.0	15 / 4.6	15 / 4.6
2-1/2 / 65	11 / 3.4	15 / 4.6	15 / 4.6	6.6 / 2.0	14 / 4.3	17 / 5.2	15 / 4.6
3 / 80	12 / 3.7	16 / 4.9	15 / 4.6	6.6 / 2.0	15 / 4.6	19 / 5.8	15 / 4.6
4 / 100	14 / 4.3	18 / 5.5	15 / 4.6	6.6 / 2.0	17 / 5.2	21 / 6.4	15 / 4.6
5 / 125	16 / 4.9	20 / 6.1	15 / 4.6	6.6 / 2.0	20 / 6.1	24 / 7.3	15 / 4.6
6 / 150	17 / 5.2	21 / 6.4	15 / 4.6	10 / 3.0	21 / 6.4	26 / 7.9	15 / 4.6
8 / 200	19 / 5.8	23 / 7.0	15 / 4.6	10 / 3.0	24 / 7.3	29 / 8.8	15 / 4.6
10 / 250	19 / 5.8	25 / 7.6	15 / 4.6	10 / 3.0	24 / 7.3	33 / 10.1	15 / 4.6
12 / 300	23 / 7.0	26 / 7.9	15 / 4.6	10 / 3.0	30 / 9.1	36 / 11.0	15 / 4.6
14 / 350	23 / 7.0	26 / 7.9	15 / 4.6		30 / 9.1	37 / 11.3	15 / 4.6
16 / 400	27 / 8.2	26 / 7.9	15 / 4.6		35 / 10.7	40 / 12.2	15 / 4.6
18 / 450	27 / 8.2	27 / 8.2	15 / 4.6		35 / 10.7	43 / 13.1	15 / 4.6
20 / 500	30 / 9.1	27 / 8.2	15 / 4.6		39 / 11.9	46 / 14.0	15 / 4.6
24 / 600	32 / 9.8	26 / 7.9	15 / 4.6		42 / 12.8	50 / 15.2	15 / 4.6

1. ANSI B31.1 Power Piping Code
2. ANSI B31.9 Building Services Piping Code
3. NFPA 13 Sprinkler systems
4. Ministry of Land & Transportation of Japan: Mechanical Equipment Construction Guide

HANGER LOCATIONS ON STRAIGHT RUNS WHERE FLEXIBLE COUPLINGS ARE USED

When flexible couplings are used on straight runs, location of hangers shall be designed as close to each coupling as possible, or within a distance of less than 1/6 the span.

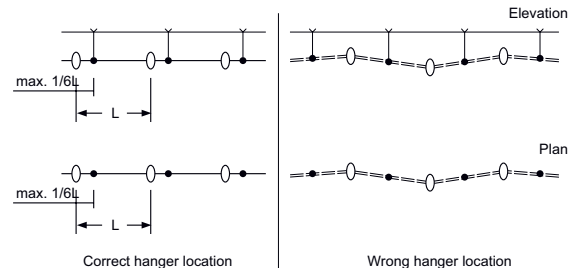

HANGER LOCATIONS ON CURVED PIPE RUNS AND BRANCH LINES

Additional hangers or supports shall be provided where runs are curved, connected to a branch line or on short risers or drops.

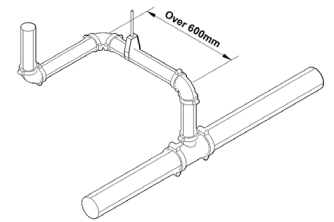
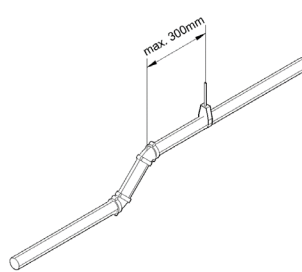
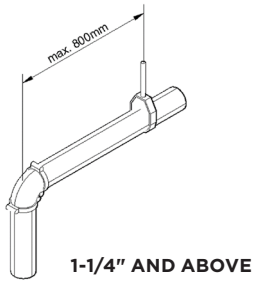
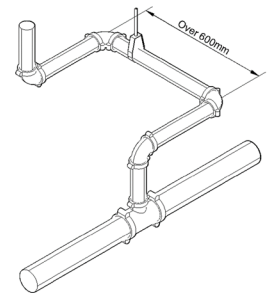
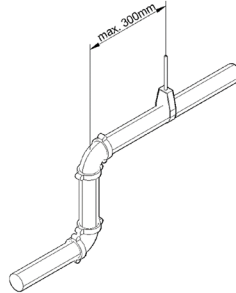
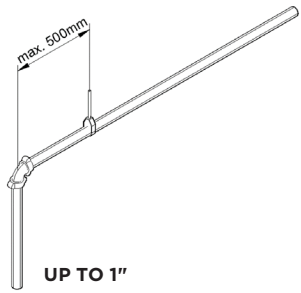

CURVED PIPE RUNS

SHORT RISER (OR SHORT DROP)

BRANCH LINE

TYPICAL DESIGNS OF HANGERS AND SWAY BRACES FOR PIPE RUNS

Pipe runs shall be adequately suspended by rod hangers or steel angles that are directly attached to the building structure to restrict the movement of the piping. Hangers and their components shall be ferrous. The maximum distance between hangers shall not exceed that specified in the table of previous page.

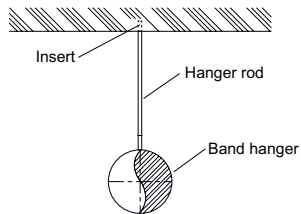

A rod hanger for a single pipe run

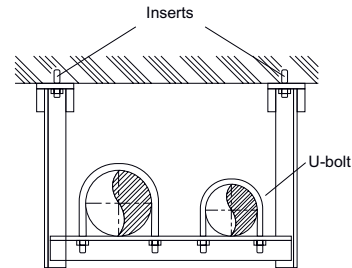

A trapeze hanger suspended from ceiling

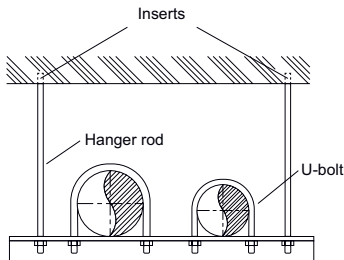

A trapeze hanger for multiple pipe runs

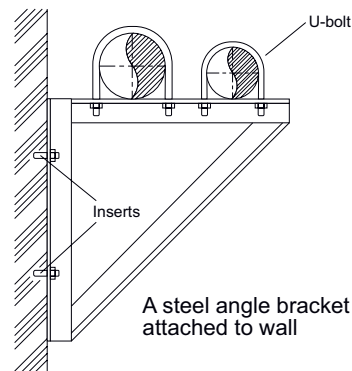

A steel angle bracket attached to wall

SUPPORTS FOR RISERS

In multi-story buildings, risers shall be fixed (or anchored) at the lowest level and at the top of the riser and shall be supported by riser clamps or U-bolts at each floor level to prevent the risers from swaying. If risers are braced by the penetration floors, the number of riser clamps or U-bolts may be reduced to one at each three stories. For risers, either flexible or rigid couplings can be used as long as proper anchoring and support is provided. Systems designers may also need to account for thermal expansion and / or contraction. Additional anchors and guides may be needed to account for changes in pipe length and proper alignment.

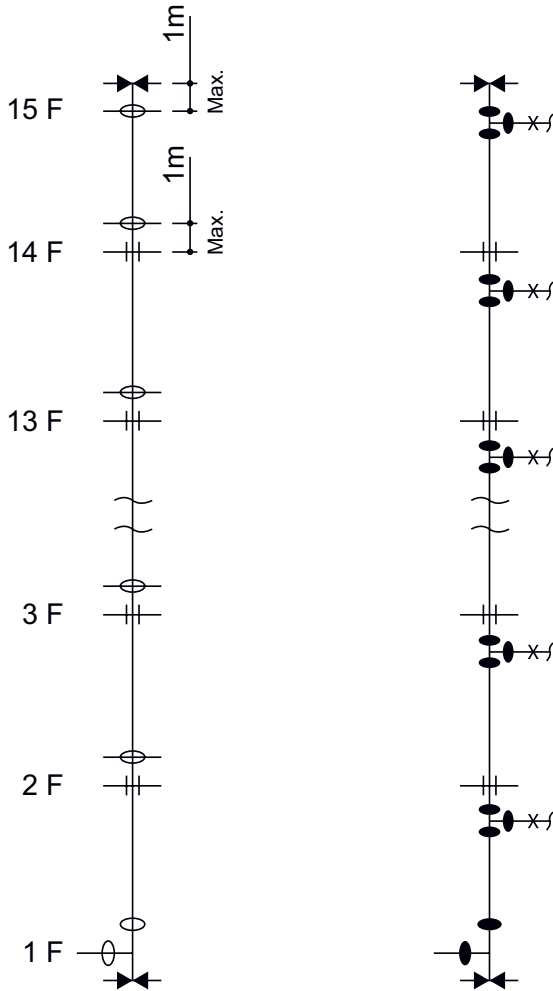

- Flexible Coupling
- Rigid Coupling
- ⊕ Anchor
- ⊕ Sway brace

- Anchors should be sufficient to hold the weight of water-filled pipe and pressure thrusts.
- Pipe guides (sway braces) should be such as to brace lateral movement of the system.

Anchors for risers (⊕)

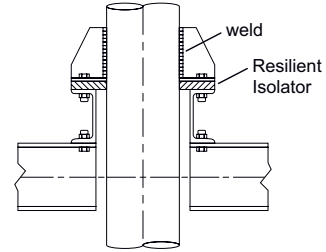

Sway brace for risers (⊕)

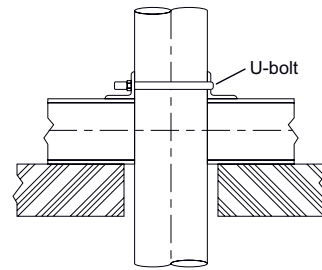

Anchor (⊕)

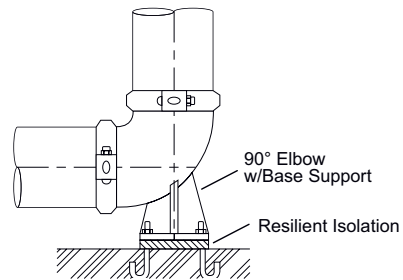





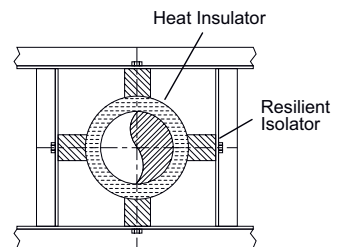
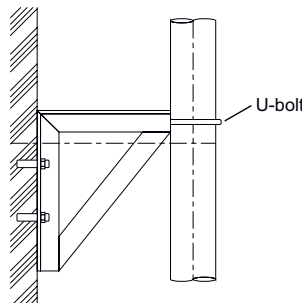



Sway brace (⊕)

Sway brace (⊕)





Over the past 50 years great advances have been made in synthetic elastomer technologies, allowing us to offer a full range of gasket materials for a wide variety of piping applications. Shurjoint utilizes the finest materials available in our gaskets which are engineered and designed to meet and exceed industry standards such as ASTM D2000, AWWA C606, NSF61, IAPMO, etc. Our continual research, development and testing all serve to advance this field and to develop new and superior solutions for our changing industry. Selecting the proper gasket for the intended service application requires careful consideration of many factors to assure maximum gasket life. Those factors include temperature, fluid media and concentration, and continuity of service. The gaskets color coding helps to identify the gasket grade and compound.

GASKET GRADE INDEX

COMPOUND	GRADE	COLOR CODE	GENERAL SERVICE RECOMMENDATIONS	MAXIMUM TEMP. RANGE
EPDM	EHM	 Green and Red Stripe	Good for cold & hot water up to +250°F (+121°C) temp range - -30°F (-34°C) to +250°F (+121°C). Also good for services for water with acid, water with chlorine, deionized water, seawater and waste water, dilute acids, oil-free air and many chemicals. Not recommended for petroleum oils, mineral oils, solvents and aromatic hydrocarbons.	-30°F (-34°C) to +230°F (+110°C)
EPDM	E	 Double Green Stripe	Good for cold & hot water up to +230°F (+110°C). Also good for services for water with acid, water with chlorine, chloramine, deionized water, seawater and waste water, dilute acids, oil-free air and many chemicals. Not recommended for petroleum oils, mineral oils, solvents and aromatic hydrocarbons.	-30°F (-34°C) to +230°F (+110°C)
Nitrile	T	 Orange Stripe	Good for petroleum oils, mineral oils, vegetable oils, non-aromatic hydrocarbons, many acids and water +150°F (+65°C).	-20°F (-29°C) to +180°F (+82°C)
EPDM	Lube-E	 Violet Stripe	UL approved pre-lubricated gasket designed specifically only for the fire protection industry.	-30°F (-34°C) to +150°F (+65°C)
White Nitrile	A	 White Gasket	Good for oily and greasy food products and processing, as well as pharmaceutical and cosmetics manufacturing. Compounded from FDA approved ingredients (CFR Title 21 Part 177.2600).	+20°F (-7°C) to +180°F (+82°C)
Silicone	L	 Red Gasket	Good for dry, hot air without hydrocarbons and some high temperature chemical services.	-30°F (-34°C) to +350°F (+177°C)
Neoprene	V	 Yellow Stripe	Good for hot lubricating oils and certain chemicals.	-30°F (-34°C) to +180°F (+82°C)
Fluoro-elastomer	O	 Blue Stripe	Good for many oxidizing acids, petroleum oils, halogenated hydrocarbons, lubricants, hydraulic fluids, organic liquids and air with hydrocarbons to +300°F (+149°C).	+20°F (-7°C) to +300°F (+149°C)
Epichloro-hydrin	M2	 White Stripe	Good for aromatic fuels at low temperatures and also for ambient temperature water.	-40°F (-40°C) to +160°F (+71°C)

SPECIAL GASKETS FOR AWWA DUCTILE IRON PIPE

COMPOUND	GRADE	COLOR CODE	GENERAL SERVICE RECOMMENDATIONS	MAXIMUM TEMP. RANGE
Nitrile	S	 Red Stripe	Specially compounded for use with AWWA ductile iron pipe and used for petroleum products, mineral oils, vegetable oils and air with oil vapors.	-20°F (-29°C) to +180°F (+82°C)
Halogenated Butyl	M	 Brown Stripe	Good for water services, mild dilute acids, oil-free air and many chemicals. The compound is UL classified per NSF/ANSI 61 & NSF/ANSI 372. (AWWA ductile iron pipe use)	-20°F (-29°C) to +200°F (+93°C)

Please note that EPDM grade "EH" gaskets can be used for all applications and services that EPDM grade "E" gaskets are suitable for.

WARNING!

EPDM gaskets for water services are not recommended for steam services. Failure to select the proper gasket and compound may result in joint leakage or failure resulting in personal and or property damage. Gaskets should never be exposed to temperatures outside their ratings.

Proper gasket selection is essential for the optimum performance of Shurjoint grooved couplings, flange adapters and mechanical tees.



Standard



Reducing



GapSeal



Reducing
(2" x 1½", 2½" x 2", 3" x 2½")



End Protection

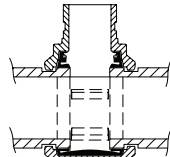

Outlet Coupling



FastFit™

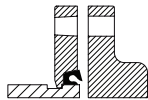

Flange Adapter

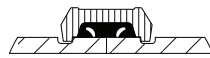

AWWA Ductile Iron Pipe

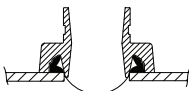

Mechanical Tee



IPS to AWWA

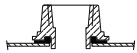

Saddle-Let

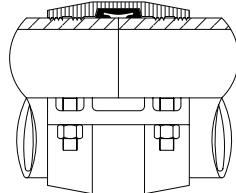

HDPE Pipe

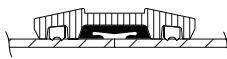

Wildcat

1. GASKET STYLES

Shurjoint grooved couplings utilize several different gasket styles, standard, GapSeal, EP (End Protection), EHM and FF (Fast Fit). GapSeal gaskets are compatible with standard gaskets and they are interchangeable with each other. Other special styles are not compatible with standard or GapSeal gaskets. Always use the correct gasket style for the coupling model you selected.

2. VACUUM SERVICE

Shurjoint standard gaskets are designed to seal well under vacuum conditions up to 10 inHg (absolute)/ 254 mmHg (absolute) which may occur when a system is drained. For continuous services greater than 10 inHg (absolute)/254 mmHg (absolute), the use of GapSeal gaskets or EP (End Protection) gaskets in combination with rigid style couplings is recommended. Contact Shurjoint for specific recommendations.

3. DRY PIPE AND FREEZER SERVICES

Shurjoint recommends the use of GapSeal Grade "E" gaskets for dry pipe fire protection systems and freezer applications. The GapSeal gasket closes off the gap between the pipes or gasket cavity. This will prevent any remaining liquid from entering the cavities and freezing when the temperature drops. Rigid couplings are preferred for dry pipe, freezer and vacuum applications. Reducing couplings are not recommended for these applications.

NOTE: For gaskets in service temperatures above 150°F (65°C), or below 33°F (0.5°C) the use of Shurjoint EHC silicone lube is required and has demonstrated increased gasket performance and longevity in testing.

4. NSF/ANSI 61 STANDARD

NSF/ANSI 61 classified gaskets are good for potable water services. The classification categories are 'cold' which is limited to +86°F (+30°C) (or maximum ambient distribution temperatures of unheated water) maximum and 'hot' which is limited to +180°F (+82°C) (or scalding temperatures of hot domestic water).

5. NSF/ANSI 372 STANDARD

MAXIMUM LEAD CONTENT (FORMERLY ANNEX G):

Product complies with NSF/ANSI 372 and conforms with lead content requirements for "lead free" plumbing as defined by California, Vermont, Maryland and Louisiana State laws and the U. S. Safe Drinking Water Act in effect as of Jan. 4, 2014.

6. LUBRICANT

Shurjoint Lubricant is recommended for proper gasket installation to prevent the gasket from being pinched. Apply a thin coat to the gasket exterior, gasket lips and/or housing interiors. Shurjoint's new quick install couplings do not require an exterior gasket lubricant on initial installation. Lubrication is only required on the sealing lips and internal areas. Shurjoint Lubricant is available in one pound (450 grams) and one quart (2 pounds or 900 grams) containers. Certified to NSF/ANSI 61.



The following are general service recommendations only and the information provided is based on the best information available from various resources including elastomer manufacturers, leading rubber molders, industry publications and our own laboratory testing and field experience. The information contained herein shall be considered for evaluation purposes and not as a guarantee. When and wherever possible, gasket materials should be tested with simulated service conditions to determine suitability for the intended service application. Unless otherwise noted, the recommendations are based on ambient temperatures. These recommendations do not apply to rubber lined products or rubber sealed valves. If more than one gasket grade is listed the preferred grade is listed first for general services. For chemicals not listed, a combination of chemicals listed or not, service temperatures not listed or borderline services, contact a Shurjoint Engineering Representative for a recommendation.

Note: NR = Not Recommended

CHEMICAL SERVICES	
CHEMICAL COMPOSITION	GASKET GRADE
Acetaldehyde	E/EHM
Acetamide	T
Acetic Acid up to 10% 100°C (38°C)	E/EHM/L
Acetic Acid up to 10-50% 100°C (38°C)	L
Acetic Acid, Glacial 100°C (38°C)	L
Acetic Anhydride	E/EHM
Acetone	E/EHM
Acetonitrile	T
Acetophenone	E/EHM
Acetylene	E/EHM/T
Acrylic Resin	V
Acrylonitrile	NR
Adipic Acid	T
Air, oil free	E/EHM
Air with vaped oil	T
Alkalis	E/EHM
Allyl Alcohol to 96%	E/EHM
Allyl Chloride	NR
Alum Sulfuric Acid	O
Alums	E/EHM/T
Aluminum Chloride	E/EHM/T
Aluminum Fluoride	E/EHM/T/O
Aluminum Hydroxide	E/EHM/O
Aluminum Nitrate	E/EHM/T/V
Aluminum Oxychloride	T
Aluminum Phosphate	E/EHM
Aluminum Salts	E/EHM/T
Aluminum Sulfate	E/EHM/T
Alums	E/EHM/T
Ammonia Anhydrous (Pure Ammonia)	NR
Ammonia Gas, Cold	E/EHM
Ammonia, Aqua, 10-25%	E/EHM
Ammonia, Liquid	E/EHM
Ammonium Alum	V
Ammonium Bifluoride	T
Ammonium Carbonate	E/EHM
Ammonium Chloride	E/EHM/T
Ammonium Fluoride	E/EHM
Ammonium Hydroxide	E/EHM
Ammonium Metaphosphate	E/EHM
Ammonium Nitrate	E/EHM/T
Ammonium Nitrite	E/EHM
Ammonium Persulfate, to 10%	E/EHM
Ammonium Phosphate	T
Ammonium Sulfamate	T
Ammonium Sulfate	E/EHM/T
Ammonium Sulfide	E/EHM
Ammonium Thiocyanate	E/EHM
Amyl Acetate	E/EHM
Amyl Alcohol	E/EHM
Amyl Borate	V
Amyl Chloride	NR
Amyl Chloronaphthalene	T
Anderol	O
Aniline	E/EHM
Aniline Dyes	E/EHM
Aniline Hydrochloride	E/EHM
Aniline Oil	E/EHM
Animal Fats	A

CHEMICAL SERVICES	
CHEMICAL COMPOSITION	GASKET GRADE
Antraquinone	NR
Antraquinone Sulfonic Acid	NR
Antimony Chloride	E/EHM
Antimony Trichloride	E/EHM
Argon Gas	E/EHM/O
Aroclor(S)	O
Arsenic Acid, to 75%	E/EHM/T/O
Arylsulfonic Acid	NR
ASTM #1, 2 & 3 Oil	T
Barium Carbonate	E/EHM
Barium Chloride	E/EHM/T
Barium Hydroxide	E/EHM/T
Barium Nitrate	V
Barium Sulfide	T
Beer	A
Beet Sugar liquors	A
Benzaldehyde	E/EHM
Benzene	O
Benzine (see Petroleum Ether)	O
Benzoic Acid	E/EHM
Benzol	O
Benzyl Alcohol	E/EHM
Benzyl Benzoate	E/EHM
Benzyl Chloride	E/EHM
Black Sulfate Liquor	T
Blast Furnace Gas	T
Bleach, 12% Active Cl ₂	E/EHM
Borax Solutions	E/EHM
Bordeaux Mixture	E/EHM
Boric Acid	E/EHM/T
Bromine	O
Bromine Water	V
Butane Gas	T
Bromotoluene	NR
Butanol (see Butyl Alcohol)	E/EHM/T
Butter	A
Butyl Acetate Ricinoleate	E/EHM/T
Butyl Alcohol	E/EHM/T
Butyl "Cellosolve Adipate"	E/EHM/T
Butyl Phenol	E/EHM
Butyl Stearate	T/O
Butylene	T/O
Butylene Glycol	E/EHM
Butyne Diol	NR
Calcium Acetate	T
Calcium Bisulphite	T/O
Calcium Carbonate	E/EHM/T
Calcium Chlorate	E/EHM/T
Calcium Chloride	E/EHM/T
Calcium Hydroxide (Lime)	E/EHM/T
Calcium Hypochlorite	E/EHM
Calcium Hypochloride	E/EHM
Calcium Nitrate	E/EHM/T/V
Calcium Sulfate	E/EHM/T
Calcium Sulfide	E/EHM/T
Caliche Liquors	T
Cane Sugar Liquors	A
Carbitol	E/EHM/T
Carbonic Acid, Phenol	O

CHEMICAL SERVICES	
CHEMICAL COMPOSITION	GASKET GRADE
Carbon Bisulphide	O
Carbon Dioxide, Dry	E/EHM/T
Carbon Dioxide, Wet	E/EHM/T
Carbon Disulphide	O
Carbon Monoxide	E/EHM
Carbon Tetrachloride	O
Carbonic Acid, Dry	O
Caster Oil	T/A
Caustic Potash	E/EHM/T
Cellosolve	E/EHM/V
Cellosolve Acetate	E/EHM
Cellosolve (Alcohol Ether)	E/EHM
Cellulose Acetate	E/EHM
Cellulube 220 (Tri-Aryl-Phosphate)	E/EHM
Cellulube Hydraulic Fluids	E/EHM
China Wood Oil, Tung Oil	T
Chloric Acid to 20%	E/EHM
Chlorine, Dry	O
Chlorine, Water 4000 PPM (max.)	E/EHM
Chlorinated Paraffin (Chlorococane)	T
Chloroacetic Acid	E/EHM
Chloroacetone	E/EHM
Chlorobenzene	O
Chloralhydrate	NR
Chlorobromomethane	NR
Chloroform	O
Chlorosulphonic Acid	NR
Chrome Alum	E/EHM/T
Chromic Acid, to 10%	O
Chromic Acid, to 25%	O
Chrome Plating Solutions	O
Citric Acid, Saturated	E/EHM
Citric Acid	E/EHM/T
Coconut Oil	A
Cod Liver Oil	A
Coke Oven Gas	T/O
Copper Carbonate	E/EHM/T
Copper Chloride	E/EHM/T
Copper Cyanide	E/EHM/T
Copper Fluoride	E/EHM
Copper Nitrate	E/EHM/T
Copper Sulfate	E/EHM/T
Corn Oil	A
Cotton Seed Oil	A
Creosol, Cresylic Acid	O
Creosote, Coal Tar	T/O
Creosote, Wood	T/O
Cupric Fluoride	E/EHM/T
Cupric Sulfate	E/EHM/T
Cyclohexane (Alicyclic Hydrocarbon)	V/O
Cyclohexanol	E/EHM
Cyclohexanone	E/EHM
Deionized Water	T
Dextrin	V
Diacetone Alcohol	E/EHM
Dibutyl Phthalate	T

CHEMICAL SERVICES	
CHEMICAL COMPOSITION	GASKET GRADE
Dichloro Difloro Methane	T
Dicyclohexylamine	T
Diesel Oil	T
Diethyl Ether	E/EHM
Diethyl Sebacate	T
Diethylamine	E/EHM/T
Diethylene Glycol	T
Digester Gas	T
Dimethylamine	E/EHM
Diocetyl Phthalate	E/EHM
Dioxane	T
Dipentene(Terpene-Hydrocarbon)	T
Dipropylene Glycol	O
Dowtherm A	O
Dowtherm E	T/E/EHM
Dowtherm SR-1	E/EHM
Ethane	E/EHM
Ethanolamine	NR
Ethers	E/EHM
Ethyl Acetoacetate	L
Ethyl Acrylate	E/EHM
Ethyl Alcohol (Ethanol)	E/EHM
Ethyl Cellulose	E/EHM
Ethyl "Cellusolve"	E/EHM
Ethyl Chloride	E/EHM/T
Ethyl Ether	T
Ethyl Oxalate	E/EHM
Ethyl Silicate	T
Ethylene Chlorohydrin	E/EHM
Ethylene Diamine	E/EHM/T
Ethylene Dichloride(Dichloroethane)	O
Ethylene Glycol	E/EHM / T
Ethylene Oxide	NR
Fatty Acid	A
Ferric Chloride, to 35%	E/EHM/T/O
Ferric Chloride, Saturated	E/EHM
Ferrous Nitrate	V
Ferric Hydroxide	E/EHM
Ferric Sulfate	T
Fish Oils (Solubles)	A
Fire Fighting Foam Concentrate	E/EHM/O
Fluoroboric Acid	E/EHM/T
Fluorine Gas, Wet	NR
Fluorosilicic Acid, to 30%	V
Fly Ash	E/EHM
FM200 HFC-227ea	E/EHM
Foam	E/EHM
Fog Oil	T
Formaldehyde	E/EHM/T
Formamide	E/EHM/T
Formic Acid, to 25%	E/EHM
Freon 11, 130°F (54°C)	T
Freon 12, 130°F (54°C)	T
Freon 113 130°F (54°C)	T
Freon 114,130°F (54°C)	T
Freon F-12	T
Freon 123	NR
Freon 134a,176° (80°C)	E/EHM/T
Freon F-21	NR
Freon 22, 130°F (54°C)	V
Fructose	E/EHM/T
Fuel Oil	T
Fumaric Acid	E/EHM
Furan	NR
Furfuryl Alcohol	E/EHM
Gallic Acid	NR
Gasoline, Refined	T
Gasoline, Refined, Unleaded	O
Gelatin	A

CHEMICAL SERVICES	
CHEMICAL COMPOSITION	GASKET GRADE
Glucose	A
Glue	E/EHM/T
Glycerin	E/EHM/T
Glycerol	E/EHM/T
Glycol	E/EHM/T
Glycolic Acid	E/EHM
Grease	T/W/O
Green Sulfate Liguor	T
Halon 1301	E/EHM
Heptane	T
Hexaldehyde	E/EHM
Hexane	T
Hexanol	T
Hexanol Tertiary	T
Hexyl Alcohol	V/T
Hexylene Glycol	T
Hydrobromic Acid, to 40%	E/EHM
Hydrochloric Acid, to 36%,75°F (24°C)	E/EHM
Hydrochloric Acid, to 36%, 158°F (70°C)	O
Hydrocyanic Acid	E/EHM
Hydrofluoric Acid, to 75%, 75°F (24°C)	O
Hydrofluosilicic Acid	E/EHM
Hydrocyanic Acid, to 10%	E/EHM
Hydrofluoric Acid, to 30%	V/O
Hydrofluosilicic Acid, to 50%	T
Hydrogen Phosphide	NR
Hydrogen Gas, Cold	E/EHM/T
Hydrogen Gas, Hot	E/EHM
Hydrogen Peroxide, to 50%	L
Hydrogen Peroxide, to 90%	O
Hydrogen Sulfide	E/EHM
Hydroquinone	T/O
Hydroxylamine Sulfate	E/EHM
Hypochlorous Acid, Dilute	E/EHM
Isododecane	V
Isobutyl Alcohol	E/EHM
Iso Octane, 100°F (38°C)	T
Isobutyl Alcohol	E/EHM
Isopropyl Acetate	E/EHM
Isopropyl Alcohol	E/EHM
Isopropyl Ether	T
JP-3	T
JP-4	T/O
JP-5	T/O
JP-6, 7, 8	T
Kerosene	T
Ketones	E/EHM
Lactic Acid	A
Lard Oil	V
Latex (1% Styrene & Butadiene)	O
Lauric Acid	T
Lauryl Chloride	NR
Lavender Oil	T
Lead Acetate	E/EHM
Lead Chloride	E
Lead Sulfamate	V
Lead Sulfate	T
Lime and H2O	E/EHM/T
Lime Sulfur	O
Linoleic Acid	O
Lithium Bromide	T
Lithium Chloride	T
Linseed Oil	A
Lithium Bromide (Brine)	T/O
Lithium Chloride	T/O
Lubricating Oil, Refined	T
Lubricating Oil, Sour	T
Lubricating Oil, to 150°F (66°C)	T
Lubricating Oil, 150°F (66°C) to 180°F (82°C)	V/T

CHEMICAL SERVICES	
CHEMICAL COMPOSITION	GASKET GRADE
Magnesium Chloride	E/EHM/T
Magnesium Hydroxide	E/EHM/T
Magnesium Nitrate	E/EHM/V
Magnesium Sulfate	E/EHM/T
Maleic Acid, Saturate	T
Malic Acid	T
Mercuric Chloride	E/EHM/T
Mercuric Cyanide	E/EHM/T
Mercurous Nitrate	E/EHM/T
Mercury	E/EHM/T
Methane	T
Methyl Acetate	V
Methyl Alcohol, Methanol	E/EHM/T
Methyl Cellosolve (Ether)	V
Methyl Chloride	O
Methyl Ethyl Ketone	NR
Methyl Isobutyl Carbinol	E/EHM
Methylene Chloride	O
Methylene Chlorobromide	NR
Methylene Dichloride 100°F (38°C)	O
MIL-L7808	O
MIL-05606	O
MIL-08515	O
Milk	A
Mineral Oils	T
Naphta	O
Naohalene	NR
Naptha, 160°F (71°C)	O
Napthenic Acid	T
Natural Gas	T
Neovil	E/EHM
Nickel Acetate to 10%, 100°F (38°C)	V
Nickel Ammonium Sulfate	V
Nickel Chloride	E/EHM/T
Nickel Nitrate	V
Nickel Plating Solution125°F (52°C) - Max.	E/EHM/T
Nickel Sulfate	E/EHM/T
Nitric Acid to 10%, 75°F (24°C) - Max.	E
Nitric Acid, 10-50%, 75°F (24°C) - Max.	O
Nitric Acid, 50-86%, 75°F (24°C)	O
Nitric Acid, Red Fuming	O
Nitrocellulose	V
Nitrogen	E/EHM
Nitromethane	E/EHM
Nitrous Oxide	E/EHM
NOVEC 1230 FK-5-1-12	E/EHM
Octyl Alcohol Vogisogric Acid, to 75%, 150°F (66°C)	O
Oil, Crude Sour	T
Oil, Motor	T
Oleic Acid	T
Olive Oil	T/A
Oronite 8200 Silicate Ester Fluid	O
Orthodichlorobenzene	O
OS-45 Silicate Ester Fluid	O
OS-45-1	O
Oxalic Acid	E/EHM
Oxygen, Cold	E/EHM
Ozone (100 ppm)	E/EHM
Palm Oil	T/A
Peanut Oil	A
Palmitic Acid	T
Pentane	T
Perchloric Acid	NR
Perchloroethylene	O
Petroleum Ether (see Benzene)	O
Petroleum Oils	T
Phenol (Carbolic Acid)	O

CHEMICAL SERVICES	
CHEMICAL COMPOSITION	GASKET GRADE
Phenylhydrazine	E/EHM
Phenylhydrazine Hydrochloride	E/EHM
Phosphate Ester	E/EHM
Phosphoric Acid, to 50%	E/EHM
Phosphoric Acid, to 75% and 70°F	E/EHM/T
Phosphoric Acid, to 85%, 150°F (66°C) - Max.	O
Phosphate Ester	E/EHM
Photographic Solutions	T
Phthalic Anhydride	E/EHM
Picric Acid	V
Plating Solutions(gold, brass cadmium, copper, lead, silver, tin, zinc)	V
Polybutene	T
Polyvinyl Acetate, Solid (In Liquid State is 50% solution of Methanol or 60% solution of H2O)	E/EHM
Potash	E/EHM
Potassium Alum	E/EHM/T
Potassium Aluminum Sulfate	E/EHM/T
Potassium Bicarbonate	E/EHM/T
Potassium Bichromate	E/EHM/T
Potassium Borate	E/EHM
Potassium Bromate	E/EHM
Potassium Bromide	E/EHM/T
Potassium Carbonate	E/EHM/T
Potassium Chlorate	T
Potassium Chloride	E/EHM/T
Potassium Chromate	T
Potassium Cyanide	E/EHM/T
Potassium Dichromate	E/EHM
Potassium Ferricyanide	E/EHM
Potassium Ferrocyanide	E/EHM
Potassium Fluoride	E/EHM
Potassium Hydroxide	T
Potassium Iodide	V
Potassium Nitrate	E/EHM/T
Potassium Perborate	E/EHM
Potassium Perchlorate	T
Potassium Permanganate, Saturated to 10%	E/EHM
Potassium Permanganate Saturate 10-25%	E/EHM
Potassium Persulfate	T
Potassium Silicate	E/EHM/T/V
Potassium Sulfate	E/EHM/T
Prestone	T
Propane Gas	T
Propanol	E/EHM
Propargyl Alcohol	E/EHM
Propyl Alcohol	E/EHM/T
Propylene Dichloride	L
Propylene Glycol	E/EHM
Pydraul F-9 and F-150	NR
Pyranol 1467	T
Pyranol 1476	T
Pyroguard "C"	T
Pyroguard "D"	T
Pyroguard 55	E/EHM
Pyrrrole	E/EHM
Ref. Fuel (70 ISO Octane, 30 Toluene)	T
Rapeseed Oil	A
Rosin Oil	T/V
Salicylic Acid	E/EHM
Secondary Butyl Alcohol	T
Sewage	E/EHM/T
Silver Nitrate	E/EHM
Silver Sulfate	E/EHM

CHEMICAL SERVICES	
CHEMICAL COMPOSITION	GASKET GRADE
Skydrol, 200°F (93°C) - Max.	L
Skydrol 500 Phosphate Ester	E/EHM
Soap Solutions	E/EHM/T
Soda Ash, Sodium Carbonate	E/EHM/T
Sodium Acetate	E/EHM
Sodium Alum	T
Sodium Benzoate	E/EHM/T
Sodium Bicarbonate	E/EHM/T
Sodium Bisulfate	E/EHM/T
Sodium Bisulfite (Black Liquor)	E/EHM/T
Sodium Bromide	E/EHM/T
Sodium Carbonate	E/EHM/T
Sodium Chlorate	E/EHM
Sodium Chloride	E/EHM/T
Sodium Cyanide	E/EHM/T
Sodium Dichromate, to 20%	E/EHM/T
Sodium Ferricyanide	E/EHM/T
Sodium Ferrocyanide	E/EHM/T
Sodium Fluoride	E/EHM/T
Sodium Hydroxide, to 15%	E/EHM
Sodium Hydro Sulfide	T
Sodium Hydroxide to 50%	E/EHM
Sodium Hypochlorite, to 20%	E/EHM
Sodium Metaphosphate	T
Sodium Nitrate	E/EHM
Sodium Nitrite	E/EHM/T
Sodium Perborate	E/EHM
Sodium Peroxide	E/EHM
Sodium Phosphate	T
Sodium Phosphate, Dibasic	T
Sodium Phosphate, Monobasic	T
Sodium Phosphate, Tribasic	T
Sodium Silicate	T
Sodium Sulfate	E/EHM/T
Sodium Sulfide	E/EHM/T
Sodium Sulfite Solution, to 20%	T
Sodium Thiosulfate, "Hypo"	T
Sohovis 47	T
Sohovis 78	T
Solvasol #1	T
Solvasol #2	T
Solvasol #3	T
Solvasol #73	T
Solvasol #74	NR
Soybean Oil	A
Spindle Oil	T
Stannic Chloride	T
Stannous Chloride, to 15%	T
Starch	E/T
Steam	NR
Stearic Acid	Zinc Nitrate
Stoddard Solvent	T
Styrene	O
Sulfonic Acid	E/EHM
Sulphite Acid Liquor	E/EHM
Sucrose Solutions	A
Sulfur	E/EHM/V
Sulfur Chloride	O
Sulfur Dioxide, Dry	E/EHM
Sulfur Dioxide, Wet	E/EHM
Sulfur Trioxide, Dry	O
Sulfuric Acid, to 25%, 150°F (66°C)	E/EHM
Sulfuric Acid, 25-50%, 200°F (93°C)	O
Sulfuric Acid, 50-95%, 150°F (66°C)	O
Sulfuric Acid, Fuming	O
Sulfuric Acid, Oleum	O
Sulfurous Acid	O
Tall Oil	T

CHEMICAL SERVICES	
CHEMICAL COMPOSITION	GASKET GRADE
Tannic Acid, all conc.	V
Tanning Liquors (50g. alum. solution,)	V
Tanning Liquors (50g. dichromate solution)	T
Tartaric Acid	E/EHM
Tertiary Butyl Alcohol	E/EHM/T
Tetrabutyl Titanate	E/EHM
Tetrachloroethylene	O
Thionyl Chloride	T
Terpineol	V
Tertiary Butyl Alcohol	E/EHM/T/V
Tetrachloroethylene	O
Tetrahydrofuran	NR
Tetralin	NR
Thiophene	NR
Titanium Tetrachloride	O
Toluene, to 30%	T
Transmission Fluid, Type A	O
Triacetin	T
Trichloroethane	O
Trichloroethylene	O
Trichloroethylene, to 200°F (93°C)	O
Tricresyl Phosphate	E/EHM
Triethanolamine	E/EHM/T
Trisodium Phosphate	E/EHM
Tung Oil	T
Turbo Oil #15 Diester Lubricant	O
Turpentine	T
Urea	T/E/EHM
Vegetable Oils	T/A
Vinyl Acetate	E/EHM
Vinegar	A
Vinyl Chloride	O
Vi-Pex	T
Water, to 150°F (66°C)	E/EHM/T/M/S
Water, to 200°F (93°C)	E/EHM/M
Water, to 230°F (110°C)	E/EHM
Water, to 250°F (121°C)	E/EHM
Water, Acid Mine	E/EHM/T
Water, Bromine	O
Water, Chlorinated, to 3500 ppm	E/EHM
Water, Chlorine	E/EHM
Water, Deionized	E/EHM/M
Water, Potable	E/EHM-pw
Water, Seawater	E/EHM
Water, Waste	E/EHM/T/M/S
Whiskey	A
White Liquor	E/EHM
Wood Oil	T
Xylene	O
Zinc Chloride, to 50%	E/EHM
Zinc Nitrate	E/EHM
Zinc Sulfate	E/EHM/T
Whiskey	A
White Liquor	E
Wood Oil	T
Xylene	O
Zinc Chloride, to 50%	E
Zinc Nitrate	E
Zinc Sulfate	E/T

The Shurjoint fire protection series numbers over 600 individual components, including grooved couplings, fittings, flanges, mechanical tees, valves, welding outlets, threaded fittings and more. Applicable products are listed and or approved by various domestic and international approval bodies including UL, FM, VdS, LPCB and others.

HYDROSTATIC TESTS

Approved products are rated in cold water pressure (CWP) tested with a 3 to 5 times test pressure depending on the approval body and pipe size. The minimum working pressure (CWP) shall be 175 psi (12.3 Bar) in accordance with NFPA 13. Approval testing of a coupling is conducted on all different pipe schedules as enrolled and approved working pressures (CWP) are assigned to each individual combination of the coupling and test pipe. Refer to the Approved Pressure Ratings by UL and FM.

HYDROSTATIC TEST PRESSURES MULTIPLE OF CWP

NOMINAL SIZE	UL	FM	VDS	LPCB
¾" - 12"	X4	X4	X4	X4
14" AND ABOVE	X3	X5	NA	NA

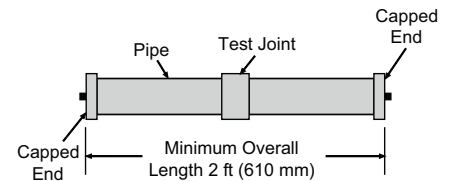

BENDING MOMENT TESTS

The required bending moment per UL and FM is calculated based on twice the weight of water filled pipe over twice the maximum distance between pipe supports as specified in NFPA 13.

See the table to the right for the bending moments per UL and FM on Sch. 40 pipe. This bending moment is twice that required by ASTM F1476.

In addition to the hydrostatic and bending moment tests, couplings must meet other requirements including gasket performance tests.

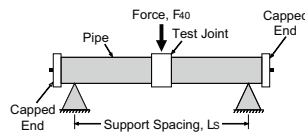
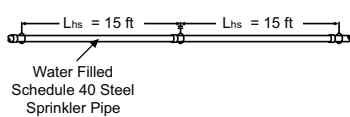

REQUIRED BENDING MOMENT UL & FM

NOM. SIZE (INCHES)	UL		FM	
	MOMENT NM	MOMENT LB-FT	MOMENT NM	MOMENT LB-FT
1-1/2	1098	810	1100	810
2	1559	1150	1560	1150
2-1/2	2400	1770	2400	1770
3	3289	2426	3290	2425
4	4942	3645	4975	3670
5	7102	5238	7105	5240
6	9606	7085	9615	7090
8	15326	11304	15335	11310
10	22757	16785	22790	16805
12	31116	22950	31145	22970
14	37217	27450		
16	48597	35843		

FLEXIBLE COUPLING

NFPA 13 defines a flexible coupling as "a listed coupling or fitting that allows axial displacement, rotation, and at least 1 degree of angular movement of the pipe without inducing harm on the pipe. For pipe diameters of 8 in. and larger, the angular movement shall be permitted to be less than 1 degree but not less than 0.5 degrees." (NFPA 13 - 2007 3.5.4)

For sprinkler systems, NFPA 13 specifies the use of flexible couplings to protect the system against damage from earthquakes and lists some specific examples of how and where they should be used. Designers and installers should design their fire protection systems in compliance with this standard.

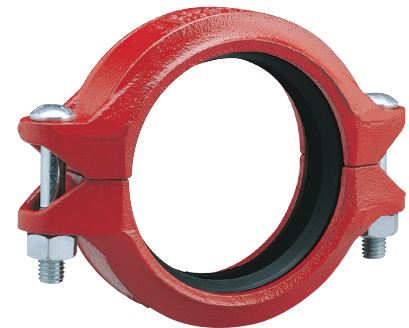

MINIMUM PIPE SCHEDULES

Standard cut and roll grooving connections have limitations of minimum pipe schedules. Special care is required for thin wall pipe. Factory Mutual Research Group (FM) outlines the minimum pipe schedules to be used for cut and roll grooving in their FM Class 1920 standard as follows:

NOMINAL PIPE SIZE IN.	GROOVING METHOD	MINIMUM PIPE SCHEDULE
6 or smaller	Cut	Schedule 40
8 or larger	Cut	Schedule 30
2 or smaller	Rolled	Schedule 5
6 or smaller	Rolled	Schedule 10, Thinwall, Lightwall
8 or larger	Rolled	0.188 in. (4.8 mm) wall

(FM Class 1920 - 2007, Table 3.2.2)

- Approved grooved couplings and fittings are good for use in both wet and dry sprinkler systems.
- Typical applications of flexible couplings (models 7705, 7706 & 7707) are in sprinkler risers, in feed mains passing through walls from one building area to another, in locations subject to earthquakes, in the discharge line from above ground pump suction tanks, in new connections to existing feed mains and in air or water fire service lines subject to excessive vibration or difficult alignment.
- Approved grooved couplings are limited to use with rolled or cut-groove ended pipe, valves and fittings at a minimum rated working pressure of 175 psi (1205 kPa) and are suitable for above ground service.
- Grooves should be processed according to ANSI/AWWA C606 (latest edition) Grooved and Shouldered Joints.
- Installation must be made according to the manufacturer's instructions and requirements.

- Approved grooved couplings may be used in underground service subject to the installation restrictions placed upon the pipe and to the coupling manufacturer's recommendations and requirements.
- Approved grooved couplings have been evaluated for a maximum ambient temperature of 225°F (107°C), suitable for normal warehouse protection.
- Threaded size of sprinkler piping is limited to 1 inch (25 mm) nominal.
- Threaded connections can be made to approved threadable thinwall pipe or to Schedule 40 pipe.

Source: FM Approval Guide

- For pressure ratings for special pipes, DIN and JIS pipe sizes, and large diameter sizes 14" – 24", contact Shurjoint for details.
- Models K-9 and 7771 rigid couplings are also available. For pressure ratings, contact Shurjoint for details.

COUPLINGS & FLANGE ADAPTERS

SCH. 40 & STD WALL PIPE

SIZE IN	WALL IN	7705		K-9		7707		7771		Z05		Z07		7041		7043		7706			
		UL	FM	UL	FM	UL	FM	UL	FM	UL	FM	UL	FM	UL	FM	UL	FM	SIZE (IN)	UL	FM	
¾	0.113	-	-	-	-	500	-	-	-	-	-	-	-	-	-	-	-	-	2 x 1-1/2	300	300
1	0.133	300	300	-	-	500	-	-	-	-	-	500	-	-	-	-	-	-	2-1/2 x 2	300	300
1-1/4	0.140	300	300	300	300	500	-	-	-	350	350	500	500	-	-	-	-	-	3 x 2	300	300
1-1/2	0.145	300	300	300	300	-	500	-	500	350	350	500	500	-	-	-	-	-	3 x 2-1/2	300	300
2	0.154	300	300	300	300	500	500	300	300	350	350	500	500	175	300	300	300	300	4 x 2	300	300
2-1/2	0.203	300	300	300	300	500	500	300	300	350	350	500	500	175	300	300	300	300	4 x 2-1/2	300	300
3	0.216	300	300	300	300	500	500	300	300	350	350	500	500	175	300	300	300	300	4 x 3	300	300
4	0.237	300	300	300	300	500	500	300	300	350	350	500	500	175	300	300	300	300	6 x 2	300	300
5	0.258	300	300	300	300	500	500	300	300	350	350	400	400	175	300	300	300	300	6 x 4	300	300
6	0.280	300	300	300	300	500	500	300	300	350	350	400	400	175	300	300	300	300	8 x 6	300	300
8	0.322	300	300	300	300	500	500	300	300	350	350	400	400	175	300	300	300	300	-	-	-
10	0.375	175 [^]	250	-	-	300	500	175	200	-	-	350	350	175	175	300	300	300	-	-	-
12	0.375	175*	250	-	-	300	300	175	300	-	-	350	350	175*	175	300	300	300	-	-	-

[^]0.188" wall, *0.330 wall

SIZE IN	WALL IN	7705H	
		UL	FM
8	0.322	450	450

Unit: psi

SCH. 10 & BS 1387 MEDIUM PIPE

SIZE IN	WALL IN	7705		K-9		7707		7771		Z05		Z07		7041		7043		7706			
		UL	FM	UL	FM	UL	FM	UL	FM	UL	FM	UL	FM	UL	FM	UL	FM	SIZE (IN)	UL	FM	
¾	0.083	-	-	-	-	500	-	-	-	-	-	-	-	-	-	-	-	-	2 x 1-1/2	300	300
1	0.109	300	300	-	-	500	-	-	-	-	-	-	500	-	-	-	-	-	-	300	300
1-1/4	0.109	300	300	300	300	500	-	-	-	350	350	500	500	-	-	-	-	-	76.1 x 2	300	300
1-1/2	1.109	300	300	300	300	-	-	-	500	350	350	500	500	-	-	-	-	-	3 x 2	300	300
2	0.110	300	300	300	300	450	450	300	300	350	350	500	500	175	300	300	300	300	3 x 2-1/2	300	300
2-1/2	0.120	300	300	300	300	450	450	300	300	350	350	500	500	175	300	300	300	300	3 x 76.1	300	300
76.1	0.142	300	300	300	-	500	500	-	300	300	-	-	-	175	-	-	-	-	4 x 2	300	300
3	0.120	300	300	300	300	450	450	300	300	350	350	500	500	175	300	300	300	300	4 x 2-1/2	300	300
4	0.120	300	300	300	300	450	450	300	300	350	350	500	500	175	300	300	300	300	4 x 76.1	300	300
5	0.134	300	300	300	300	450	450	300	300	350	350	400	400	175	300	300	300	300	4 x 3	300	300
139.7	0.197	300	300	300	-	500	500	-	300	-	-	-	-	175	-	-	-	-	6 x 3	300	300
6	0.134	300	300	300	300	450	450	300	300	350	350	400	400	175	300	300	300	300	165.1 x 3	-	300
165.1	0.197	300	300	300	-	500	500	-	300	-	-	-	-	175	-	-	-	-	6 x 4	300	300
8	0.188	300	300	300	300	450	450	300	300	350	350	400	400	175	300	300	300	300	165.1 x 4	300	300
10	0.188	175	175	-	-	300	450	175	200	NA	NA	350	350	175	175	300	300	300	8 x 6	300	300
12	0.250	175*	175	-	-	300	300	175	300	NA	NA	350	350	175*	175	300	300	300	8 x 165.1	-	300

*0.330 wall

SIZE IN	WALL IN	7705H	
		UL	FM
8	0.188	450	450

Unit: psi

OUTLET COUPLING & MECHANICAL TEES

MODEL	SIZES (IN) (RUN X BRANCH)	SCH. 40/STD		SCH. 10		
		UL	FM	UL	FM	
C-7 Outlet Coupling, Threaded	1-1/2 x 1/2, 3/4 & 1	300	300	300	300	
	2 x 1/2, 3/4 & 1	300	300	300	300	
	2-1/2 x 1/2, 3/4 & 1	300	300	300	300	
	3 x 3/4 & 1	300	300	300	300	
	4 x 3/4 & 1	300	300	300	300	
	6 x 1 & 1-1/2	300	300	300	300	
C-7 Outlet Coupling, Grooved	2 x 1	300	300	300	300	
	2-1/2 x 1-1/4 & 1-1/2	300	300	300	300	
	3 x 1 & 1-1/2	300	300	300	300	
	4 x 1-1/2 & 2	300	300	300	300	
	6 x 1-1/2 & 2	300	300	300	300	
M21 Mechanical Tee, Threaded (NPT or BSPT)	2 x 1/2, 3/4, 1, 1-1/4 & 1-1/2	300	300	300	300	
	2-1/2 x 1/2, 3/4, 1, 1-1/4 & 1-1/2	300	300	300	300	
	76.1 x 1/2, 3/4, 1, 1-1/4 & 1-1/2	300	300	300	300	
	3 x 1/2, 3/4, 1, 1-1/4, 1-1/2 & 2	300	300	300	300	
	4 x 1/2, 3/4, 1, 1-1/4, 1-1/2, 2 & 2-1/2	300	300	300	300	
	4 x 76.1	300	300	300	300	
	4 x 3	175	175	175	175	
	5 x 2 & 2-1/2	300	300	-	-	
	5 x 3	300	-	-	-	
	139.7 x 2, 76.1 & 3	300	300	300	300	
	6 x 1-1/4, 1-1/2, 2 & 2-1/2	300	300	300	300	
	6 x 3 & 4	175	175	175	175	
	165.1 x 1-1/4, 1-1/2, 2 & 76.1	300	300	300	300	
	165.1 x 3 & 4	175	175	175	175	
	M22 Mechanical Tee, Grooved	2 x 1, 1-1/4 & 1-1/2	300	300	300	300
2-1/2 x 1, 1-1/4 & 1-1/2		300	300	300	300	
76.1 x 1, 1-1/4 & 1-1/2		300	300	300	300	
3 x 1, 1-1/4, 1-1/2 & 2		300	300	300	300	
4 x 1, 1-1/4, 1-1/2, 2 & 2-1/2		300	300	300	300	
4 x 76.1		300	300	300	300	
5 x 2 & 2-1/2		300	300	300	300	
4 x 3		175	175	175	175	
139.7 x 76.1		300	300	300	300	
6 x 1-1/4, 1-1/2, 2 & 2-1/2		300	300	300	300	
6 x 3 & 4		175	175	175	175	
165.1 x 1-1/4, 1-1/2, 2 & 76.1		300	300	300	300	
165.1 x 3 & 4		175	175	175	175	
7721 Threaded (NPT or BSPT)		4 x 3	300	300	300	300
		8 x 2, 2-1/2, 3 & 4	300	300	300	300
	8 x 76.1	300	300	300	300	
7722 Grooved	4 x 3	300	300	300	300	
	8 x 2, 2-1/2, 3 & 4	300	300	300	300	
	8 x 76.1	300	300	300	300	
7723 Threaded (NPT or BSPT)	1-1/4 x 1/2 x 3/4 & 1	300	300	300	300	
	1-1/2 x 1/2 x 3/4 & 1	300	300	300	300	
	2 x 1/2 x 3/4 & 1	300	300	300	300	
	2-1/2 x 1/2 x 3/4 & 1	300	300	300	300	

mm size pipe per EN 10255

GROOVED-END FITTINGS

MODEL	SIZE RANGE	UL	FM
901 S/R 90 Elbow	2" thru 8"	300	300
903 S/R Tee	2" thru 8"	300	300
	76.1, 165.1	300	-
	1" thru 8"	300	500
7110 90 Elbow	10", 12"	300	300
	14" thru 18"	300	175
	24"	-	175
	1"	-	500
	1-1/4" thru 8"	300	500
7111 45 Elbow	10", 12"	300	300
	14" thru 18"	300	175
	20"	250	250
	24"	250	175
	7110DR Drain Elbow	2" thru 6"	300
7110LR 1.5D Elbow	2" thru 8"	300	300
7112 22-1/2 Elbow	1-1/4"	-	300
	1-1/2"	500	300
	2" thru 8"	300	300
7113 11-1/4 Elbow	1-1/4" thru 1-1/2"	-	300
	2" thru 8"	300	300
	1-1/4" thru 8"	300	500
7120 Tee	10" thru 14"	300	300
	18"	300	-
7121 Reducing Tee	2"x1-1/2" thru 8" x 6"	300	300
	12" x 10"	300	-
7130 Lateral	2" thru 8"	300	300
7135 Cross	2" thru 6"	300	300
	8"	300	-
7150 Conc. Reducer	2" x 1-1/2" thru 14" x 12"	300	300
	16" x 8" thru 18" x 16"	300	-
7150F Socket Adapter	1-1/2" x 1" thru 4" x 2-1/2"	300	300
	5" x 1-1/2" thru 6" x 4"	300	-
7150M Red. Nipple	1-1/2" x 1" thru 6" x 4"	300	300
7160T Transition Fitting	2" x 1" thru 6" x 2"	300	300
7151 Ecc. Reducer	2-1/2" x 2" thru 8" x 6"	300	300
	10" x 8" thru 14" x 12"	-	300
7160 End Cap	1-1/4" thru 12"	300	300
7160H End Cap	10" thru 12"	300	300
	14" thru 18"	300	175
	20" thru 24"	250	175
7170 Flange Adapter	2-1/2" thru 6"	175	175
7180 Flange Adapter	2" thru 8"	300	300
7181 Red. Flange	3" x 2" thru 6" x 4"	-	300
55 Nipple Adapter	1-1/2" thru 2"	300	300

* 20" only for UL

Unit: psi

VALVES & COMPONENTS

MODEL	SIZE RANGE	UL	FM
RCV Riser Check Valve	2-1/2" thru 6"	300	300
726 Y-Strainer	2" thru 6"	300	-
	8" thru 12"	175	-
SJ-300F Butterfly Valve	2-1/2" thru 6"	300	300
	8"	300	-

Unit: psi

STAINLESS STEEL SERIES

SCH. 40S & 10S PIPE

SIZE IN	SCH. 10S WALL (IN)	SS-7		SS-8		SS-41		SS-723		
		UL	FM	UL	FM	UL	FM	UL	FM	
1	0.109	300	300	300	300	-	-	1-1/4 x 1/2	300	300
1-1/4	0.109	300	300	300	300	-	-	1-1/4 x 3/4	300	300
1-1/2	0.109	300	300	300	300	-	-	1-1/4 x 1	300	300
2	0.109	300	300	300	300	175	300	1-1/2 x 1/2	300	300
2-1/2	0.120	300	300	300	300	175	300	1-1/2 x 3/4	300	300
3	0.120	300	300	300	300	175	300	1-1/2 x 1	300	300
4	0.120	300	300	300	300	175	300	2 x 1/2	300	300
5	0.134	300	300	300	300	-	-	2 x 3/4	300	300
6	0.134	300	300	250	300	175	300	2 x 1	300	300
8	0.148	300	300	-	300	-	-	-	-	-

Unit: psi

COPPER TUBING SERIES

TYPE K & TYPE L COPPER TUBING

SIZE IN	TYPE K WALL (IN)	TYPE L WALL (IN)	C341	
			UL	FM
2	0.083	0.070	200	-
2-1/2	0.095	0.080	200	-
3	0.109	0.090	200	-
4	0.134	0.110	200	-
5	0.160	0.123	200	-
6	0.192	0.140	200	-

Unit: psi

FM: Type K only

MODEL	SIZE RANGE	UL	FM
C10 90 Elbow	2" through 4"	175	200
C11 45 Elbow	2" through 4"	175	200
C20 Tee	2" through 6"	175	200
C21 Reducing Tee	2-1/2" x 2" thru 6" x 5"	200	-
C26 Reducing Tee	2" x 3/4" thru 4" x 1/2"	200	-
C50 Conc. Reducer	2-1/2" x 2" thru 6" x 5"	200	-
C52 Conc. Reducer	2" x 1" thru 4" x 2"	200	-
C60 Cap	2" thru 4"	200	200

Unit: psi

The following tables show Shurjoint Couplings used on carbon steel, stainless steel pipe, and copper tubing; listed by IAPMO in accordance with CSA B242.

MODEL Z05 RIGID COUPLING

NOM. SIZE	PIPE O.D.	PRESSURE RATINGS	MIN. WALL
in	in	PSI	Roll (mm)
mm	mm	Bar	Cut (mm)
1-1/4	1.660	350	1.7
32	42.2	24	3.6
1-1/2	1.900	350	1.7
40	48.3	24	3.7
2	2.375	350	1.7
50	60.3	24	3.9
2-1/2	2.875	350	2.1
65	73.0	24	4.8
3	3.500	350	2.1
80	88.9	24	4.8
4	4.500	350	2.1
100	114.3	24	5.2
5	5.563	350	2.8
125	141.3	24	5.2
6	6.625	350	2.8
150	168.3	24	5.6
8	8.625	350	2.8
200	219.1	24	6.1

MODEL Z07 RIGID COUPLING

NOM. SIZE	PIPE O.D.	PRESSURE RATINGS	MIN. WALL
in	in	PSI	Roll (mm)
mm	mm	Bar	Cut (mm)
1-1/4	1.660	500	1.7
32	42.2	35	3.6
1-1/2	1.900	500	1.7
40	48.3	35	3.7
2	2.375	500	1.7
50	60.3	35	3.9
2-1/2	2.875	500	2.1
65	73.0	35	4.8
3	3.500	500	2.1
80	88.9	35	4.8
4	4.500	500	2.1
100	114.3	35	5.2
5	5.563	400	2.8
125	141.3	28	5.2
6	6.625	400	2.8
150	168.3	28	5.6
8	8.625	400	2.8
200	219.1	28	6.1
10	10.750	350	3.4
250	273.0	24	6.4
12	12.750	350	4.0
300	323.9	24	7.1

MODEL 7705 FLEXIBLE COUPLING

NOM. SIZE	PIPE O.D.	PRESSURE RATINGS	MIN. WALL
in	in	PSI	Roll (mm)
mm	mm	Bar	Cut (mm)
1-1/4	1.660	300	1.7
32	42.2	20	3.6
1-1/2	1.900	300	1.7
40	48.3	20	3.7
2	2.375	300	1.7
50	60.3	20	3.9
2-1/2	2.875	300	2.1
65	73.0	20	4.8
3	3.500	300	2.1
80	88.9	20	4.8
4	4.500	300	2.1
100	114.3	20	5.2
5	5.563	300	2.8
125	141.3	20	5.2
6	6.625	300	2.8
150	168.3	20	5.6
8	8.625	300	2.8
200	219.1	20	6.1
10	10.750	175	3.4
250	273.0	12	6.4
12	12.750	175	4.0
300	323.9	12	7.1

MODEL 7705 FLEXIBLE COUPLING

NOM. SIZE	PIPE O.D.	PRESSURE RATINGS	MIN. WALL
in	in	PSI	Roll (mm)
mm	mm	Bar	Cut (mm)
1-1/4	1.660	500	1.7
32	42.2	35	3.6
1-1/2	1.900	500	1.7
40	48.3	35	3.7
2	2.375	450	1.7
50	60.3	31	3.9
2-1/2	2.875	450	2.1
65	73.0	31	4.8
3	3.500	450	2.1
80	88.9	31	4.8
4	4.500	450	2.1
100	114.3	31	5.2
5	5.563	450	2.8
125	141.3	31	5.2
6	6.625	450	2.8
150	168.3	31	5.6
8	8.625	450	2.8
200	219.1	31	6.1
10	10.750	450	3.4
250	273.0	31	6.4
12	12.750	300	4.0
300	323.9	20	7.1

MODEL 7706 FLEXIBLE COUPLING

NOM. SIZE	PIPE O.D.	PRESSURE RATINGS	MIN. WALL
in	in	PSI	Roll (mm)
mm	mm	Bar	Cut (mm)
2-1/2 x 2	2.875 x 2.375	300	2.1 x 1.7
65 x 50	73.0 x 60.3	20	4.8 x 3.9
3 x 2	3.500 x 2.375	300	2.1 x 1.7
80 x 50	88.9 x 60.3	20	4.8 x 3.9
3 x 2-1/2	3.500 x 2.875	300	2.1 x 2.1
80 x 65	88.9 x 73.0	20	4.8 x 4.8
4 x 2-1/2	4.500 x 2.875	300	2.1 x 2.1
100 x 65	114.3 x 73.0	20	5.2 x 4.8
4 x 3	4.500 x 3.500	300	2.1 x 2.1
100 x 80	114.3 x 88.9	20	5.2 x 4.8
5 x 4	5.563 x 4.500	300	2.8 x 2.1
125 x 100	141.3 x 114.3	20	5.2 x 5.2
6 x 4	6.625 x 4.500	300	2.8 x 2.1
150 x 100	168.3 x 114.3	20	5.6 x 5.2
8 x 6	8.625 x 6.625	300	2.8 x 2.8
200 x 150	219.1 x 168.3	20	6.1 x 5.6

MODEL SS-7 RIGID COUPLING

NOM. SIZE	PIPE O.D.	PRESSURE RATINGS	MIN. WALL
in mm	in mm	PSI Bar	Roll (mm) Cut (mm)
1-1/4 32	1.660 42.2	300 20	1.7 3.6
1-1/2 40	1.900 48.3	300 20	1.7 3.7
2 50	2.375 60.3	300 20	1.7 3.9
2-1/2 65	2.875 73.0	300 20	2.1 4.8
3 80	3.500 88.9	300 20	2.1 4.8
4 100	4.500 114.3	300 20	2.1 5.2
5 125	5.563 141.3	300 20	2.8 5.2
6 150	6.625 168.3	300 20	2.8 5.6
8 200	8.625 219.1	300 20	2.8 6.1

MODEL C305 RIGID COUPLING

NOM. SIZE	PIPE O.D.	PRESSURE RATINGS	MIN. WALL
in mm	in mm	PSI Bar	Roll (mm)
2 50	2.125 54.0	300 20	1.1
2-1/2 65	2.625 66.7	300 20	1.1
3 80	3.125 79.4	300 20	1.1
4 100	4.125 104.8	300 20	1.5
5 125	5.125 130.2	300 20	1.8
6 150	6.125 155.6	300 20	2.1

MODEL C306 REDUCING COUPLING

NOM. SIZE	PIPE O.D.	PRESSURE RATINGS	MIN. WALL
in mm	in mm	PSI Bar	Roll (mm x mm)
2-1/2 x 2 65 x 50	2.625 x 2.215 66.7 x 54.0	300 20	1.1 x 1.1
3 x 2 80 x 50	3.125 x 2.125 79.4 x 54.0	300 20	1.1 x 1.1
3 x 2-1/2 80 x 65	3.125 x 2.625 79.4 x 66.7	300 20	1.1 x 1.1
4 x 2-1/2 100 x 65	4.125 x 2.625 104.8 x 66.7	300 20	1.5 x 1.1
4 x 3 100 x 80	4.125 x 3.125 104.8 x 79.4	300 20	1.5 x 1.1
5 x 4 125 x 100	5.125 x 4.125 130.2 x 104.8	200 14	1.8 x 1.5
6 x 4 150 x 100	6.125 x 4.125 155.6 x 104.8	200 14	2.1 x 1.5

MODEL C307 TRANSITION COUPLING

NOM. SIZE	PIPE O.D.	PRESSURE RATINGS	MIN. WALL
in mm	in mm	PSI Bar	Roll (mm)
2 50	2.375 x 2.125 60.3 x 54.0	300 20	1.1
2-1/2 65	2.875 x 2.625 73.0 x 66.7	300 20	1.1
3 80	3.500 x 3.125 88.9 x 79.4	300 20	1.1
4 100	4.500 x 4.125 114.3 x 104.8	300 20	1.5

Note:
Minimum wall thickness listed corresponds to Table1 of ASME B36.10M Roll/Cut groove for carbon steel & stainless steel pipe end or Table 1 of ASTM B306 for copper tubing.

The following illustrations are part of NFPA 13 – 2013 Annex A Explanatory Material. These are for informational purposes only and not a mandatory requirement. For specific requirements for any other areas of sprinkler systems, refer to the latest version of NFPA 13.

1. FLEXIBLE COUPLINGS FOR MAIN RISERS AND BRANCH LINE RISER

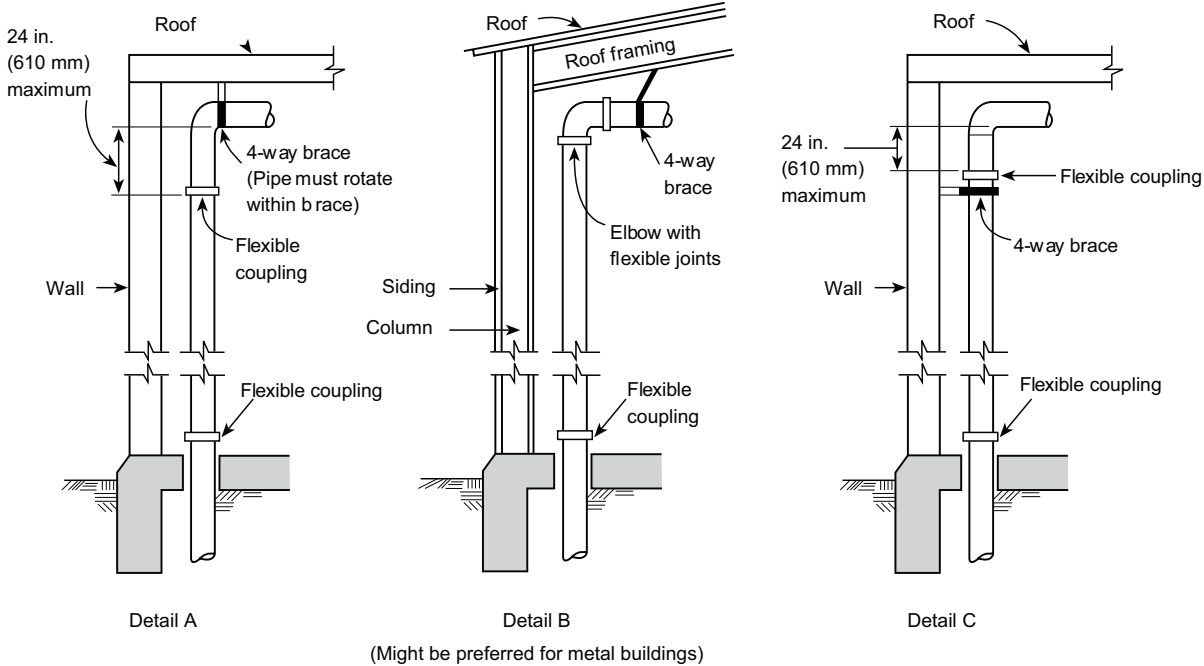

Note to Detail A: The four-way brace should be attached above the upper flexible coupling required for the riser and preferably to the roof structure if suitable. The brace should not be attached directly to a plywood or metal deck.

FIGURE A.9.3.2(a) Riser Details

2. FLEXIBLE COUPLINGS ON HORIZONTAL PORTION OF TIE-IN

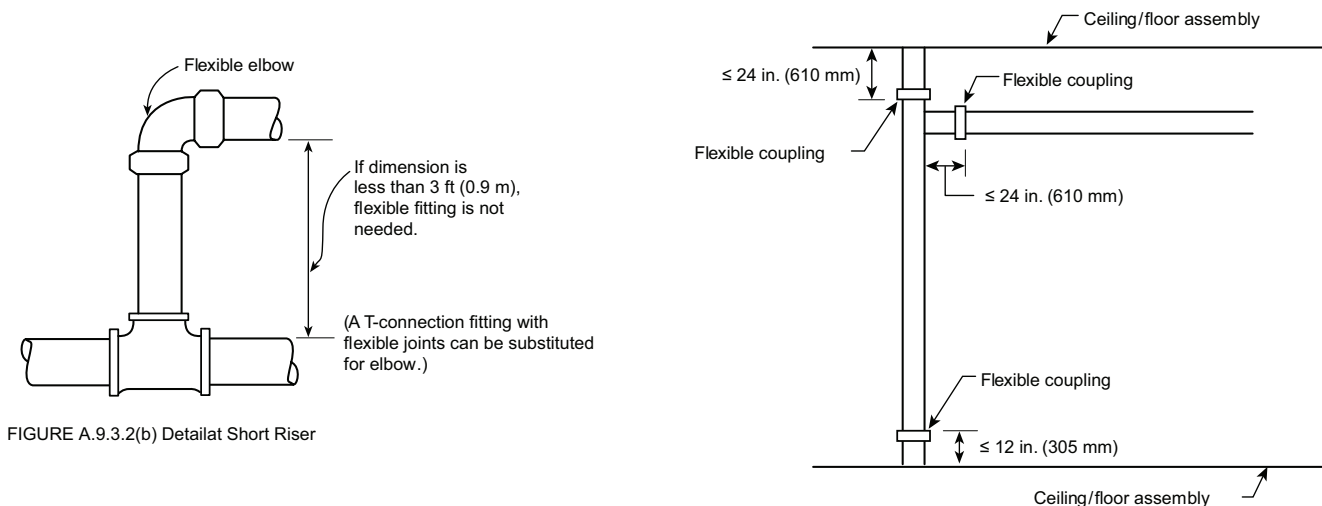

FIGURE A.9.3.2(b) Detail at Short Riser

FIGURE A.9.3.2.3(2) Flexible Coupling on Horizontal Portion of Tie-In

3. FLEXIBLE COUPLING ON MAIN RISER AND BRANCH LINE RISER

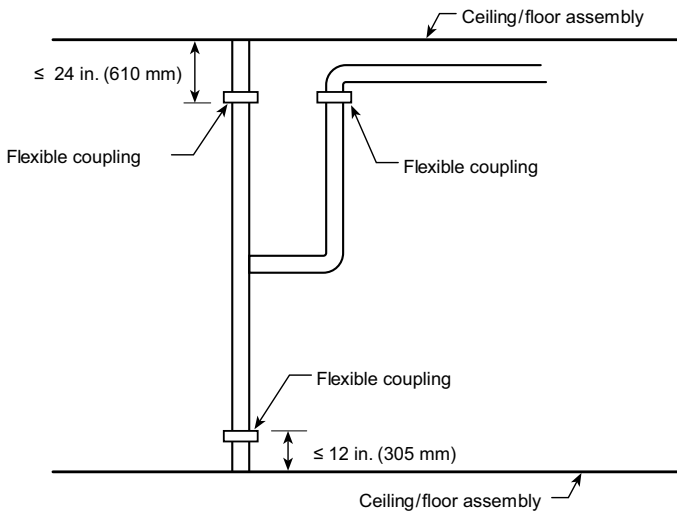

FIGURE A.9.3.2.3(2)(b) Flexible Coupling on Main Riser and Branch Line Riser

4. FLEXIBLE COUPLINGS FOR DROPS

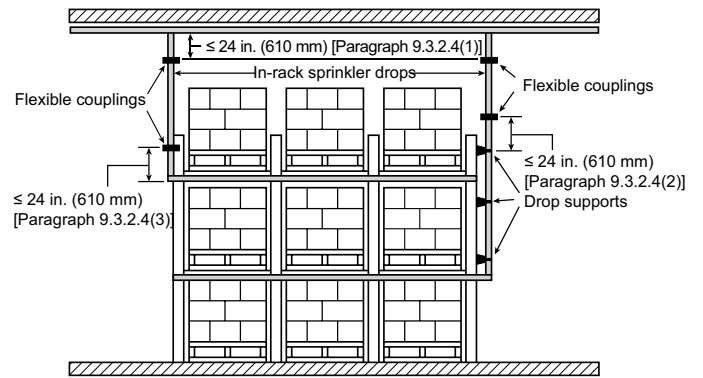
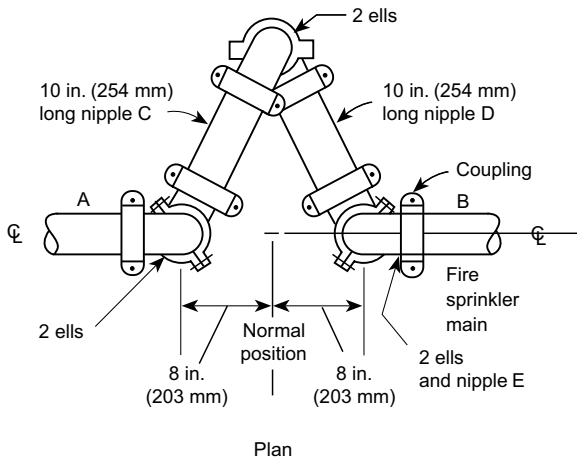
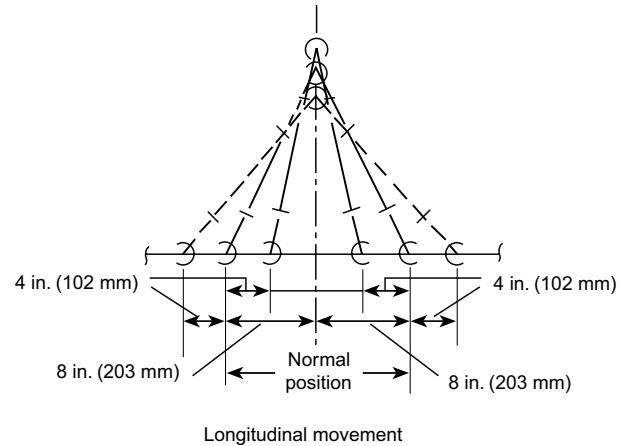

FIGURE A.9.3.2.4 Flexible Couplings for Drops

5. SEISMIC SEPARATION ASSEMBLY



Plan



Longitudinal movement

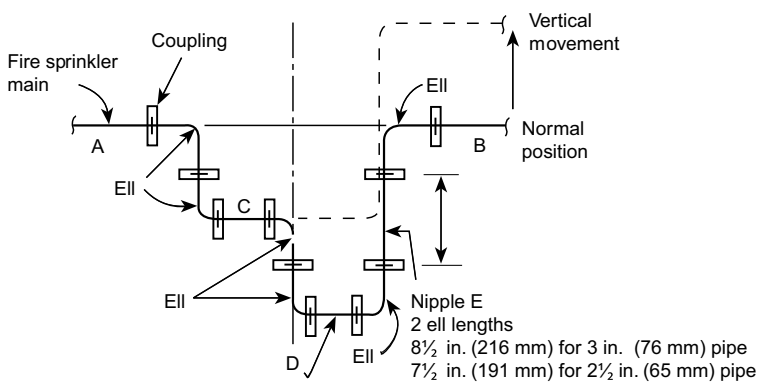

Elevation

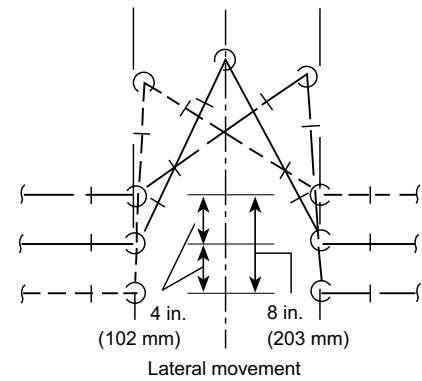

Lateral movement

Horizontal Views

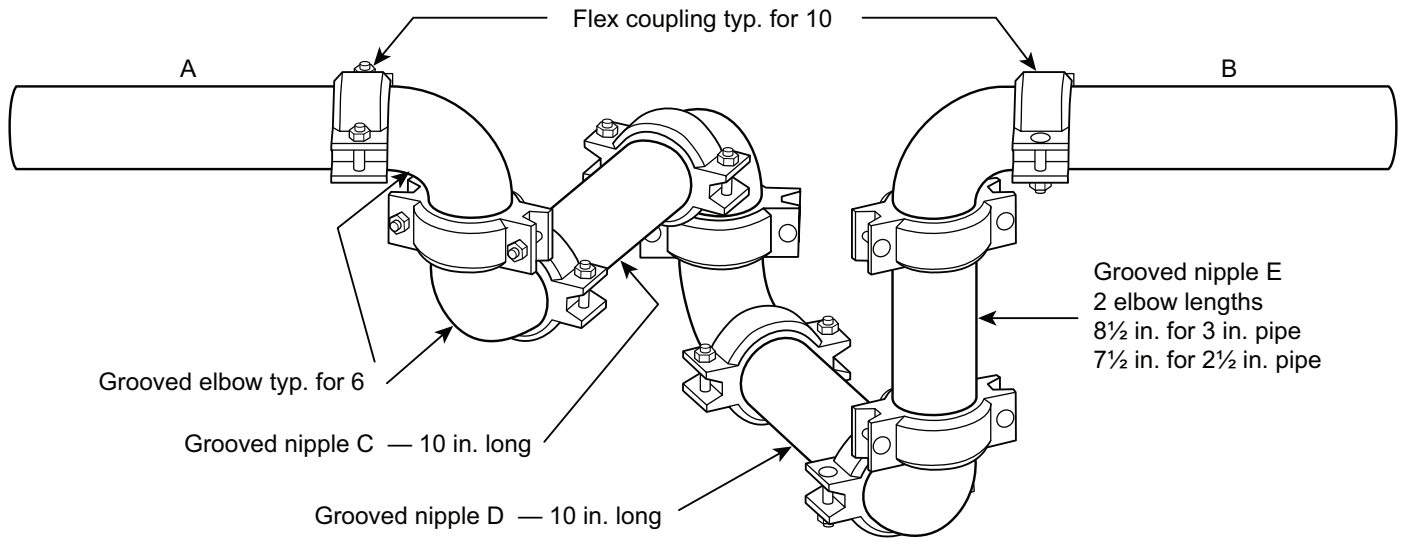

Actual View

6. EARTHQUAKE PROTECTION FOR SPRINKLER PIPING

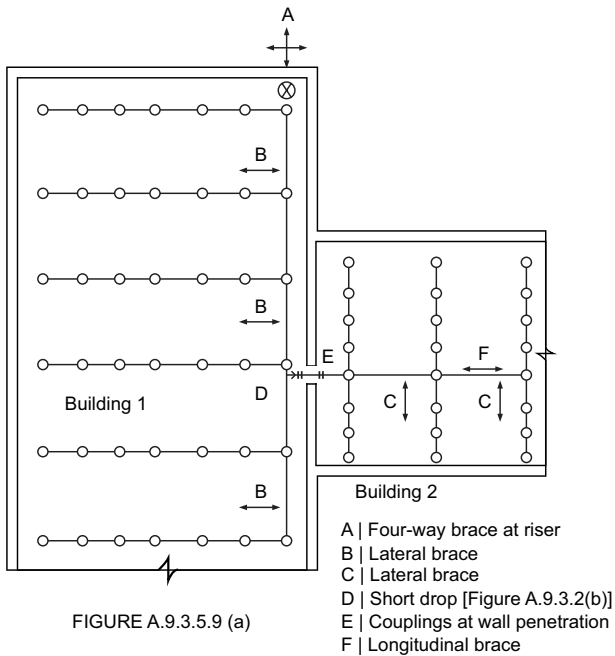

FIGURE A.9.3.5.9 (a)

7. TYPICAL LOCATION OF BRACING ON A LOOPED SYSTEM

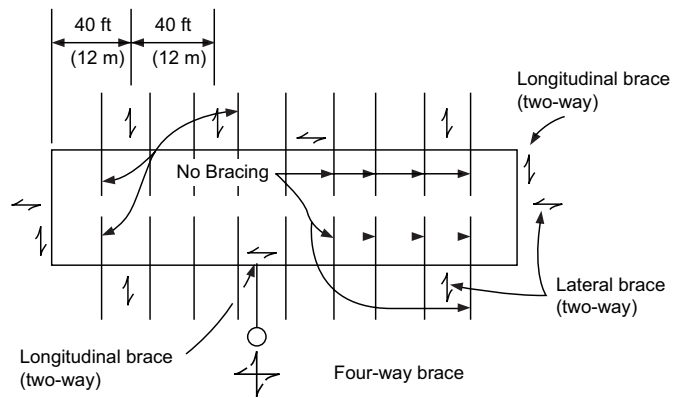

FIGURE A.9.3.5.6 (d)
Typical Location of Bracing on a Looped System.

Systems having more flexible couplings than required above shall be provided with additional sway bracing. A lateral brace shall be provided within 24" (600 mm) of every other coupling unless pipes are supported by rods less than 6" (152 mm) long from the ceiling or by U-type hooks underside of the structural element. (NFPA 13 – 2013 9.3.2. & 9.3.5.)

Since the inception in 1975, Aalberts is where technology matters and real progress can be made - humanly, financially and environmentally. At Aalberts, we create mission-critical products surrounding valve and connection technology supporting our brand, "Apollo".

The manufacturing of Consolidated Brass Company (later called Conbraco) began in 1928, in Detroit, Michigan with a focus on ball cocks, air cocks and similar products. In 1955, the manufacturing operation moved to the Carolinas spanning North and South Carolina with 3 facilities. In 2010, Aalberts, a global Dutch company, purchased Conbraco. Today the "Apollo" brand is manufactured under the company name, Aalberts integrated piping systems, in 3 locations throughout South Carolina. Over the last 90 years the product portfolio has continued to grow to encompass ball valves, butterfly valves, safety relief valves, control valves, mixing valves and backflow preventors.

These systems are applicable for key verticals such as residential, commercial, industrial, and utility. Our products are designed and developed by our team of innovators and engineers. Our design services team can assist in helping you determine the best techniques for your application with our products. We are the only company that truly offers customers a complete solution every time that is made and sourced from the same organization.

Don't just buy products, buy solutions.

