

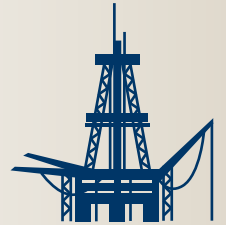

The Right Connection®

Petrochemical Life Cycle



① ② ③ Exploration and Production

dixonvalve.com • *Customer Service: 877.963.4966*



Petrochemical Life Cycle ① Exploration and Production

The content in this phase of the Petrochemical Life Cycle (see pages 22-23) is focused on the numerous transfer applications in the oil and gas field. Featured are the Dixon products used within the Exploration / Production and Transportation segment.

Please refer to the Dixon Price List or dixonvalve.com for specific part numbers and various other products used in the transfer and control of liquids, gases and dry materials.

Table of Contents

Boss Low Pressure System Products Introduction.....	3
Combination Nipples - Short and Standard.....	4
Frac Fittings	5
One-Piece and Two-Piece Hammer Union Nuts	6
Flange Adapters	7
Hammer Unions and Hammer Union Caps & Plugs.....	8
Cam & Groove, Abrasion Resistant Inserts, King Safety Cables	9
Vent-Lock Cam & Groove.....	10
EZ Boss-Lock and King Crimp Couplers.....	10
Holedall External Swage	11
Bauer Style Quick Connect	11
GSM Armored Hose	11
Rail Car Unloading	12-13
Dry Disconnects	13
Low Pressure Swivels	14
Safety Breakaways.....	14
Valves	15-16
Hydraulic Quick-Disconnects.....	17-20
Hydraulic Adapters	21
Air & Water Utilities.....	21
Petro-Chemical Lifecycle.....	22-23

Safety

Dixon's couplings and retention devices are designed to work safely for their intended use. The selection of the proper hose, coupling and retention device, and the proper application of the coupling to the hose are of utmost importance.

Users must consider the size, temperature, application, media, pressure and hose and coupling manufacturer's recommendations when selecting the proper hose assembly components. Dixon recommends that all hose assemblies be tested in accordance with the Association for Rubber Products Manufacturers (ARPM) recommendations and be inspected regularly (before each use) to ensure that they are not damaged or have become loose. Visit ARPMINC.com for more information.

Where safety devices are integral to the coupling, they must be working and utilized. The use of supplementary safety devices such as safety clips or safety cables are recommended.

If any problem is detected, couplings must be removed from service immediately.

Dixon is available to consult, train and recommend the proper selection and application of all fittings we sell. We strongly recommend that distributors and end users make use of Dixon's Testing and Recommendation Services. Call 877.963.4966 or click dixonvalve.com to learn more.

BOSS LPS Products

Low Pressure Systems

Dixon is committed to understanding customer challenges and developing solutions. Key to achieving these objectives is Dixon's Innovation Center, an engineering, research and training facility integral in the development of the Boss LPS products defined in this brochure.



Hydraulic Fracturing Site

Boss LPS (Low Pressure System) products are used in many of the applications found at hydraulic fracturing sites from the water source up to high pressure pumps. Please refer to the following pages for detailed information on Dixon's newest and rapidly expanding product line.

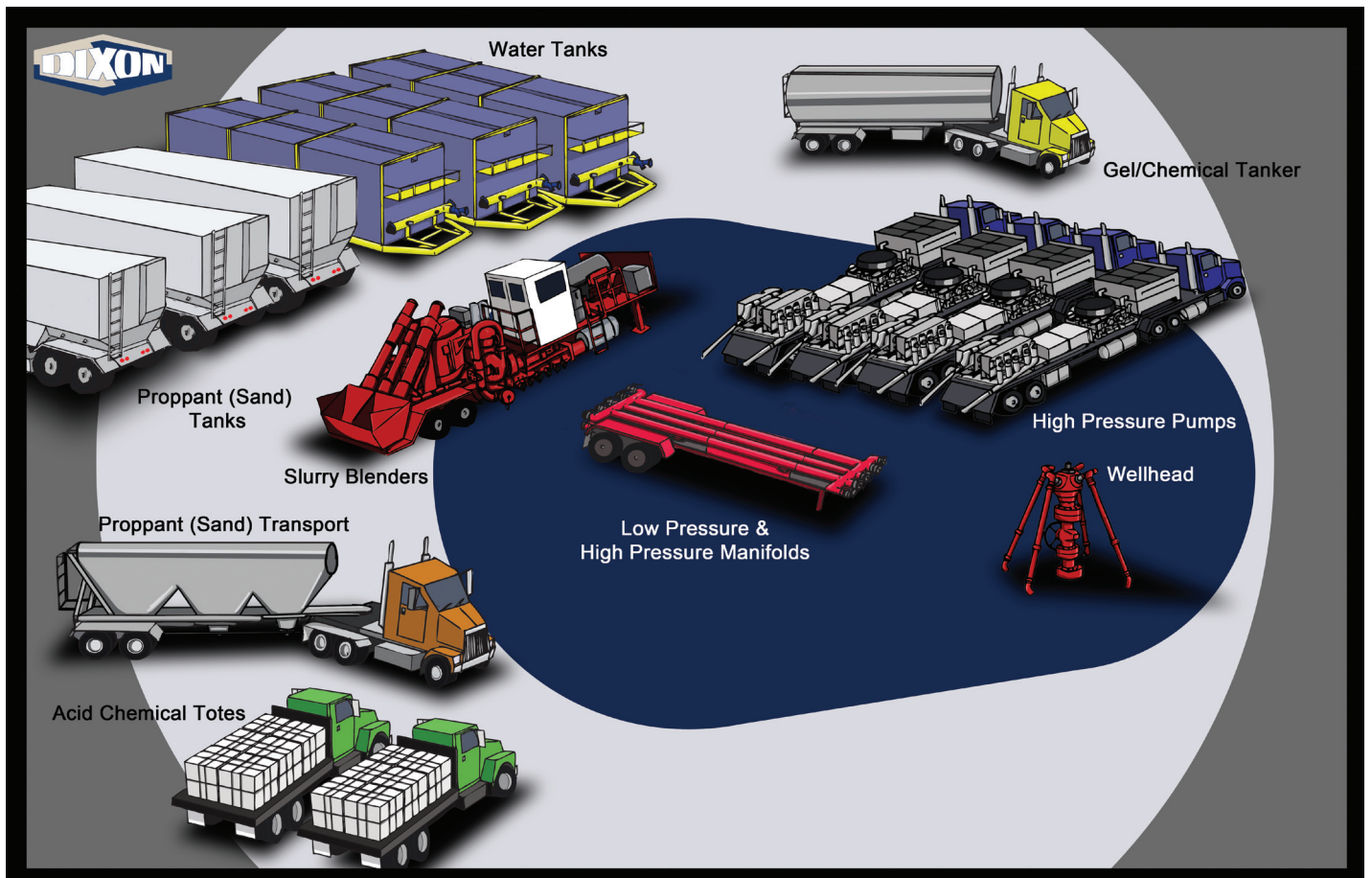

King Crimp Style Short Combination Nipples, Ferrules and Sleeves



Application:

- recommended for low-pressure discharge and suction service for compatible liquids

Material:

- schedule 40 plated carbon steel to ASTM standards

Size:

- 8"



Size	Grooved (plated) Part #	NPT (plated) Part #	Description
8"	STV80CS	STC80CS	short combination nipple
	CFS800-1CS through CFS800-8CS		ferrules (carbon steel, .120 wall thickness), other sizes made to order, call Dixon for more information
	S900X400X120CS, S925X400X120CS		sleeves (carbon steel, .120 wall thickness), other sizes made to order, call Dixon for more information

Grooved and NPT Threaded End King Combination Nipples



grooved end



NPT threaded end

Application:

- recommended for low-pressure transfer and suction service for compatible liquids

Feature:

- crimp sleeves are available and recommended for reliable assemblies
- **contact Dixon for compatible sleeve recommendations for these nipples**

Materials:

- unplated steel and plated steel

Sizes:

- ½" through 12"

Size	Grooved (unplated) Part #	NPT (plated) Part #	Description
8"	STV80	STC80	standard combination nipple
10"	STV100	STC100	standard combination nipple
12"	STV120	STC120	standard combination nipple

Special Sleeve and Ferrule Part Numbering System

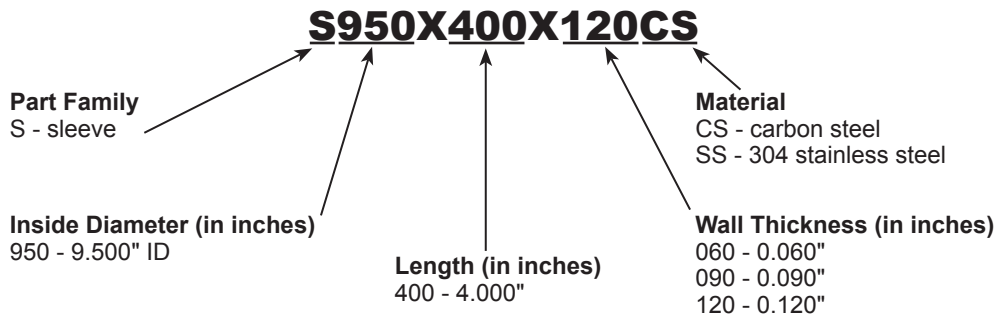

One-Piece Dixon Frac Fittings

Application:

- used in the transfer of water, chemicals and sand slurry at hydraulic fracturing sites

Features:

- one-piece stem design eliminates leak path experienced with two-piece threaded systems
- interchangeable with current fittings; phase them into your operation
- 400 PSI (28 BAR) working pressure at 70°F (21°C) for 3" and 4" sizes; 4:1 safety factor (SF) ¹
- 150 PSI (10 BAR) working pressure at 70°F (21°C) for 6" size; 4:1 safety factor (SF)
- 150 PSI (10 BAR) working pressure at 70°F (21°C) for 8" size; 3:1 safety factor (SF)



Figures 100 and 206 available



Materials:

- frac fittings: machined iron to ASTM standards; all stems zinc plated
- male 3", 4" and 6" NPT fittings are schedule 80 pipe; 8" NPT fittings are schedule 40 pipe; all sizes meet ASTM standards



Figures 100 and 206 available

Sizes:

- 3", 4", 6" and 8"

¹ 400 PSI (28 BAR) working pressure with a minimum 4:1 safety factor (*hose burst: hose working pressure*) is only achieved with:

- 3" size uses standard crimp ferrules
- 4" size requires heavy duty (HD) crimp ferrules, CF400-6CSDH through CF400-16CSDH

Note: Water and petroleum transfer hoses rated from 100 to 300 PSI (7 to 21 BAR) WP (4:1 SF) have excellent test results with the standard King Crimp ferrules *CF400-xxCS*.



Figure 100		
Size	Part #	Description
3"	HUF100300CS	female fitting
	HUM100300CS	male fitting (includes nut)
	STC35CS	male NPT fitting
	HU100300N	wing nut
4"	HUF100400CS	female fitting
	HUM100400CS	male fitting (includes nut)
	STC40CSDH	male NPT fitting
	HU100400N	wing nut
6"	HUFALL600CS	female frac fitting
	HUM100600CS	male frac fitting (includes nut)
	STC60CS	male NPT fitting
	HU100600N	wing nut (forged)
8"	HUFALL800CS	female frac fitting
	HUM100800CS	male frac fitting (includes nut)
	HU100800N	wing nut (forged)

Figure 206		
Size	Part #	Description
3"	HUF206300CS	female fitting
	HUM206300CS	male fitting (includes nut, O-ring)
	STC35CS	male NPT fitting
	HU206300N	wing nut
4"	HUF206400CS	female fitting
	HUM206400CS	male fitting (includes nut, O-ring)
	STC40CSDH	male NPT fitting
	HU206400N	wing nut
6"	HUFALL600CS	female frac fitting
	HUM206600CS	male frac fitting (includes nut, O-ring)
	STC60CS	male NPT fitting
	HU206600N	wing nut (forged)
8"	HUFALL800CS	female frac fitting
	HUM206800CS	male frac fitting (includes nut, O-ring)
	HU206800N	wing nut (forged)

- 2" will be available soon

One-Piece Hammer Union Nuts

Application:

- used with any hammer union fittings requiring reliable nuts

Features:

- long lasting and dependable nut
- all nuts are interchangeable with reliable brands
- 2,000 PSI (138 BAR) cold working pressure
- 6" and 8" sizes have a 4 lug design for more surface area to hammer

Material:

- forged steel meeting AISI standards

Sizes:

- 3", 4", 6" and 8"



3" and 4"



6" and 8"

Size	Part #	Description
3"	HU100300N	wing nut, figure 100
	HU206300N	wing nut, figure 206
4"	HU100400N	wing nut, figure 100
	HU206400N	wing nut, figure 206
6"	HU100600N	wing nut, forged, figure 100
	HU206600N	wing nut, forged, figure 206
8"	HU100800N	wing nut, forged, figure 100
	HU206800N	wing nut, forged, figure 206

Two-Piece Hammer Union Nuts

Applications:

- replacement for damaged hammer union nuts
- used with male one-piece flange adapters

Features:

- lug design provides enlarged surface area to hammer
- repair nut is pinned and bolted for perfect alignment
- nut can be installed on pre-existing hammer union assembly
- 2,000 PSI (138 BAR) cold working pressure
- 4" Figure 200/206 nut is interchangeable with reliable brands
- 6" and 8" Figure 100/200/206 nuts are interchangeable with reliable brands

Material:

- forged steel meeting AISI standards

Sizes:

- 4", 6" and 8" (bolts included)



Dixon recommends using Loctite® Threadlocker Red 271™ when bolting together two-piece hammer union nuts to ensure that bolts do not loosen when in service. Option two is to weld the seams of the split nut. Bolt torque recommendation is 60 foot pounds.



Size	Part #	Description
4"	HU200400RN	split nut, figure 200/206, blue (bolts included)
6"	HU100600RN	split nut, figure 100, black (bolts included)
	HU200600RN	split nut, figure 200/206, blue (bolts included)
8"	HU100800RN	split nut, figure 100, black (bolts included)
	HU200800RN	split nut, figure 200/206, blue (bolts included)

One-Piece Flange Adapters

Application:

- used in the transfer of water, brine, water-based chemicals, water-based acids, and gelatinous proppant (sand) slurry at hydraulic fracturing sites

Features:

- flange x female or male hammer union straights (standard or short length)
- 45° elbows in female and male (flange x hammer union)
- no welds or pipe threads to deteriorate causing premature leakage
- two-piece nut is pinned and bolted for perfect alignment
- all 4" Figure 206 threads are interchangeable with other reliable brands
- all 4" 150# flanges are compatible with other reliable brands

Material:

- iron adapters meet ASTM standards
- forged steel nuts meet AISI standards

Size:

- 4"

Size	Part #	Description	Overall Length
4"	HUF206400FLG	flange x female hammer union	5-1/8"
	HUF206400FLG-ST	flange x female hammer union, short	3"
	HUM206400FLG	flange x male hammer union (includes nut, bolts and Buna-N O-ring)	5-5/32" (with nut)
	HUM206400FLG-ST	flange x male hammer union, short (includes nut, bolts and Buna-N O-ring)	3-13/32" (with nut)
	HUF206400FLG-45	flange x female 45° elbow	10-31/32"
	HUM206400FLG-45	flange x male 45° elbow (includes nut, bolts and Buna-N O-ring)	12-1/32" (with nut)



One-Piece 150# Flange to Weld Adapters

Application:

- used on a 12" pipe manifold to transfer water, brine, water-based chemicals, water-based acids or gelatinous proppant (sand) slurry at hydraulic fracturing sites

Features:

- no welds or pipe threads to deteriorate causing premature leakage
- easy to weld to 12" pipe manifolds
- formed butt weld provides accurate alignment
- the 4" 150# flange is compatible with other reliable brands

Material:

- WCA (weldable cast steel, grade A) meeting ASTM standards

Sizes:

- 7½" and 10½" lengths standard

Size	Part #	Description
7½"	WA4FL12X750-1	150# flange x weld adapter, 1 hole
7½"	WA4FL12X750-2	150# flange x weld adapter, 2 holes
10½"	WA4FL12X1050-1	150# flange x weld adapter, 1 hole
10½"	WA4FL12X1050-2	150# flange x weld adapter, 2 holes

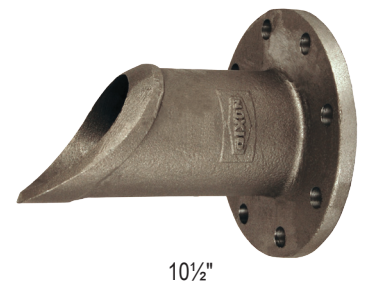

1-Hole Pattern



2-Hole Pattern

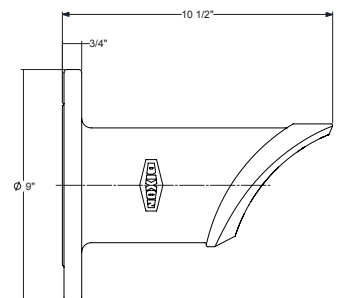
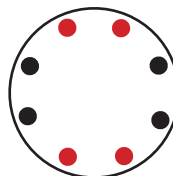

Hammer Unions



100 series



200/206 series

Application:

- used in the transfer of water, chemicals and sand slurry at hydraulic fracturing sites

Features:

100 series:

- used on low pressure manifolds and lines in applications running air, water, oil or gas up to 1,000 PSI (69 BAR) NSCWP (non-shock cold working pressure)
- threaded and buttweld ends available

200/206 series:

- used in general service applications running air, water, oil or gas up to 2,000 PSI (138 BAR) NSCWP (non-shock cold working pressure)
- O-ring mounted fitting body

Materials:

- 100 series: steel; 200/206 series: forged steel

Sizes:

- 100 series: 2", 2½", 3", 4", 6" and 8"
- 200/206 series: 1", 1½", 2", 2½", 3", 4", 6" and 8"

Hammer Union Caps and Plugs

Application:

- prevents leakage of hydraulic fracturing fluids from hammer union connections used on manifolds and hose assemblies; the fracking equipment can be in pressurized service or in transit to an alternate location



cap

Features:

- caps and plugs are produced of forged steel to ensure longevity, reliability and performance
- cap is designed with larger lugs for easier installation and disassembling
- cap design includes a threaded bolt hole for attaching chain or cable
- plug is designed with larger handle for easier installation and disassembling
- plug design includes a handle hole to attach chain or cable
- chain is zinc plated for longer life

Material:

- forged steel meeting AISI standards
- chain is welded Grade 30 steel
- bolt is Class 2A
- other materials available contact Dixon

Size:

- 4"



plug

Size	Part #	Description
4"	HUC207400	blanking cap, Figure 207
	HUP207400	blanking plug, Figure 207
	HUCH20CS	chain is 5/16" links by 20" overall length
	HUBT716X75	bolt is 7/16"-14 threads by 3/4" long
	HUC207400BC	blanking cap with bolt/chain
	HUP207400C	blanking plug with chain

Cam & Groove

Application:

- used as fittings for sand and ceramic proppants (material that keeps an induced hydraulic fracture open following a fracturing treatment)

Feature:

- adapters also available, contact Dixon for information or visit dixonvalve.com

Materials:

- unplated, plated malleable iron or ductile iron

Sizes:

- 1½", 2", 3", 4" and 6"

Size	Dixon / Boss-Lock Type E Part #	Dixon Type C Part #	Boss-Lock Type C Part #
1½"	150-E-MI	150-C-MI	IC150
2"	200-E-MI	200-C-MI	IC200
3"	300-E-MI ^{1, 2}	300-C-MI ¹	IC300
4"	400-E-MI ^{1, 2}	400-C-MI ¹	IC400 ¹
6"	600-E-MI ^{1, 2}	600-C-MI ¹	IC600 ¹

¹ ductile iron

² King Crimp style



Dixon Type C



Dixon / Boss-Lock Type E

Abrasion Resistant Inserts

Application:

- for extending the life of adapters when transferring proppant to storage tanks

Features:

- abrasion resistance extends life of adapters
- available with multiple adapter materials

Materials:

- insert: UHMW polyethylene
- adapters: aluminum, brass, iron, stainless steel

Size:

- 4"

Part #	Description
400-A-ALINSERT	aluminum adapter with insert
400-A-BRINSERT	brass adapter with insert
400-A-MIINSERT	iron adapter with insert
400-A-SSINSERT	stainless steel adapter with insert

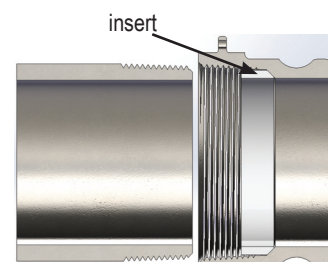

King Safety Cables

Application:

- When hose, couplings or clamps fail, or there is an accidental separation of the assembly, King safety cables minimize injuries to operators and damage to equipment by providing a standby safety for hose.

Features:

- WSR for hose-to-tool service and W for hose-to-hose service; other cable options are available, contact Dixon for additional information or visit dixonvalve.com

Materials:

- steel or stainless steel



Style WSR for hose-to-tool service



Style W for hose-to-hose service

Vent-Lock (safety cam and groove)



Vent-Lock Type C



Vent-Lock Type A

Application:

- transfer of liquids and solids, with a safer disconnection

Features:

- safety release cam and groove couplings that permit the release of static pressure when disconnecting hose assembly
- venting system protects operator from being sprayed with hazardous or non-hazardous fluids

Materials:

- 316 stainless steel
- other materials to be available, contact Dixon

Sizes:

- 1", 2"

Size	Vent-Lock Type A Part #	Vent-Lock Type C Part #	Vent-Lock Type E Part #	Vent-Lock Type DC Part #	Vent-Lock Type DP Part #
1"	L100-A-SS	L100-C-SS	L100-E-SS	L100-DC-SS	L100-DP-SS
2"	L200-A-SS	L200-C-SS	L200-E-SS	L200-DC-SS	L200-DP-SS

EZ Boss-Lock and King Crimp Couplers

EZ Boss-Lock and King Crimp Couplers

Applications:

- suitable for water, chemical, acid, and crude transfer as well as other petrochemical applications; creates a reliable assembly when used with King crimp sleeves and ferrules

Features:

- positive lock handles - prevent accidental uncoupling (EZ Boss-Lock female couplers)
- handles lock automatically when closed (EZ Boss-Lock)
- handles available in forged brass or investment cast stainless steel to meet chemical requirements
- sleeve and ferrule wall thickness varies from .062" to .120"
- working pressures are available, call Dixon or visit dixonvalve.com for information

Materials:

- EZ Boss-Lock: 316 stainless steel
- King Crimp couplers and adapters: aluminum, brass, 316 stainless steel or unplated iron
- sleeves and ferrules: stainless or carbon steel

Sizes:

- EZ Boss-Lock and King Crimp couplers and adapters: 1"- 6"
- King Crimp sleeves: 1"- 12"
- King Crimp ferrules: 1"- 8"



Not recommended for compressed gas, air or steam

Under no circumstances should the EZ Boss-Lock cam arms be used on any fitting not specifically designed for their use.



Pressure rating on King Crimp adapters is based on the seal of the mating part.

Only use the crimp style shanks with the crimp style sleeves and ferrules. Due to differences in dimensions and tolerances for safety reasons, do not interchange other manufacturer's products with Dixon products.

Holedall External Swage Fittings

Applications:

- used in suction and return lines for drilling mud, oil suction and discharge, loading and unloading

Features:

- system requires no bolts and provides a coupling with no protrusions
- hose of various lengths and styles can be coupled
- available with pipe thread, plain, grooved or flanged ends
- 300-600 PSI working pressure depending on size, call Dixon for more information
- Dixon Holedall stems and ferrules are specifically designed to be used together as a coupling system. Due to differences in dimensions and tolerances, for safety reasons, do not use other manufacturer's stems or ferrules with Dixon Holedall products. 

Materials:

- stainless steel or carbon steel

Sizes:

- 1½" - 10" hose ID

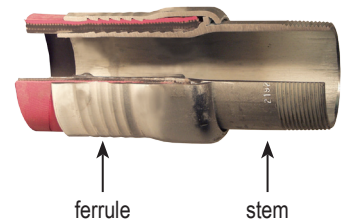

Bauer Style Quick Connect Fittings

Applications:

- used in the transfer of water and other liquids used in various oilfield applications

Features:

- hot dipped galvanized fittings with a double pin locking lever provide smooth closing action
- safety pin, standard with coupler, prevents accidental openings
- configurations include 45° and 90° elbows, ASA flange, hose shank, NPT, butt-weld, plugs, gaskets and extra long
- not recommended for use with chemicals or any hazardous type materials 
- additional configurations available, call Dixon for information

Material:

- galvanized steel

Sizes:

- 2" - 12"



male x hose shank



female x hose shank

GSM Armored Hose

Applications:

- fluid transfer on drilling platforms, blenders and equipment, mobile off-highway equipment for supporting oil and gas services in the field

Features:

- extremely flexible armor protects from heat and harsh environments in applications for steam, water, gases, hydraulic fluids, grease and abrasives
- heat resistant insulation to 1000°F
- temperature rating depends on specific applications, consult Dixon
- a variety of end connections are available

Materials:

- armor: galvanized steel or stainless steel
- wide selection of inner hoses specific to the demands of the application are industrial, hydraulic, stainless steel or PTFE

Sizes:

- ¼" through 12" bore with lengths to 120'

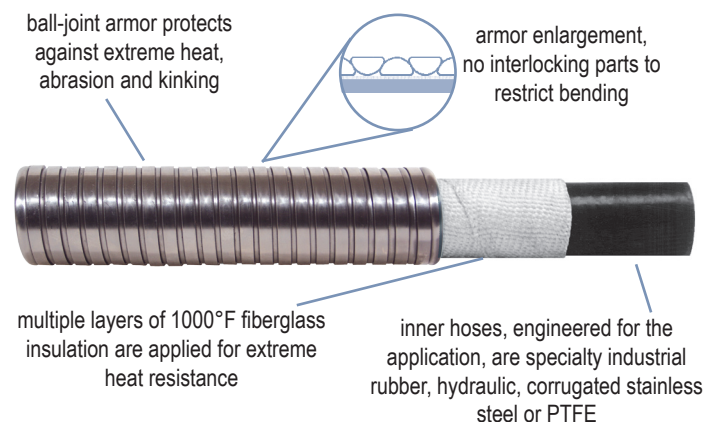

Rail Car Unloading

Rail Car Unloading Assemblies

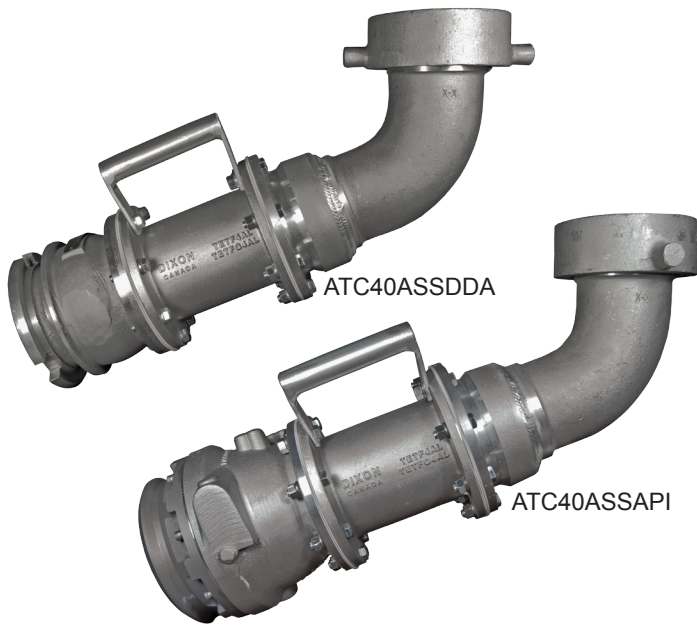

Application:

- used to connect to rail cars for the loading and unloading of crude oil and other media used in the petrochemical field

Features:

- rugged body construction
- easy carry handle
- safe and reliable - valves will not open unless fittings are properly connected
- API configuration uses a stainless steel spring on the adapter and coupler for corrosion resistance
- drain and sample ports and many other configurations are available, call Dixon for information

Material:

- body: aluminum

Size:

- 4"

Components for Custom Assemblies

- additional components are available, please send an email to sales@dixonvalve.com or call 800.355.1992 for more information



4" transfer hose fittings



4" dry disconnect and API fittings



4" sight glass



4" flange extension



ball valve



mates to a tank car with 5" male tank car thread



mates to a tank car with 4" cam and groove connections

Rail Car Unloading Dry Disconnects

Products Used with Rail Car Adapters

Application:

- ensures a quick and spill-free connection in the bulk transfer of petroleum and chemicals

Features:

- coupler has built-in swivel
- shaft journal in stainless steel embedded in PTFE eliminates seizure
- riveted piston pin to minimize the risk for failure under extreme pressure conditions
- the protective ring is a specially formulated, weather resistant and electrically conductive rubber compound

Materials:

- aluminum
- rollers: aluminum-bronze on stainless steel shaft
- stainless steel ball bearings

Size:

- 4"



API Coupler

Features:

- coupler includes a snap-on connection

Materials:

- aluminum
- nose seal - bonded FKM-B

Size:

- 4"



Cam and Groove Style Dry Disconnects

Features:

- compatible with most cam and groove style dry disconnects
- spring loaded sealing device "snaps" closed should the valve become disconnected with the poppet open
- two-piece adapter design allows easy rebuilding of adapters
- EZ Boss-Lock cam arms provide security against accidental opening
- automatic closing poppet assembly
- stainless steel handle allows product exposure to corrosive chemicals or wash down service
- fully interchangeable with Kamvalok® style fittings

Sizes:

- 1½", 2" and 3" female NPT x 2", 2½" and 4" coupler and adapter

Materials:

- stainless steel or aluminum
- call Dixon for information on chemical compatibility, size, material selection and special configurations

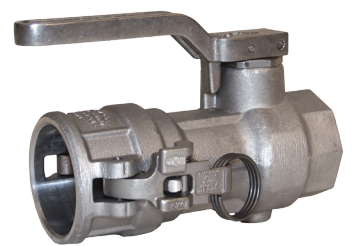

straight coupler



DBA adapter

Low Pressure Swivels

Applications:

- V-ring: loading arm, floating roof drain, floating suction
- O-ring: loading arm, hose loaders

Features:

- full 360° rotational movement offers maximum flexibility
- wide spacing between dual ball bearing raceways ensures greater load-bearing capacity
- precision-machined design ensures alignment and years of trouble-free service
- an O-ring dust seal protects the ball races and seal chamber from outside elements.
- radius elbow design ensures a smooth flow pattern

Materials:

- V-ring: carbon steel, stainless steel or aluminum
- O-ring: carbon steel, stainless steel, aluminum brass or iron

Sizes:

- V-ring: 2" through 8"
- O-ring: 1" through 4"



Typical Applications

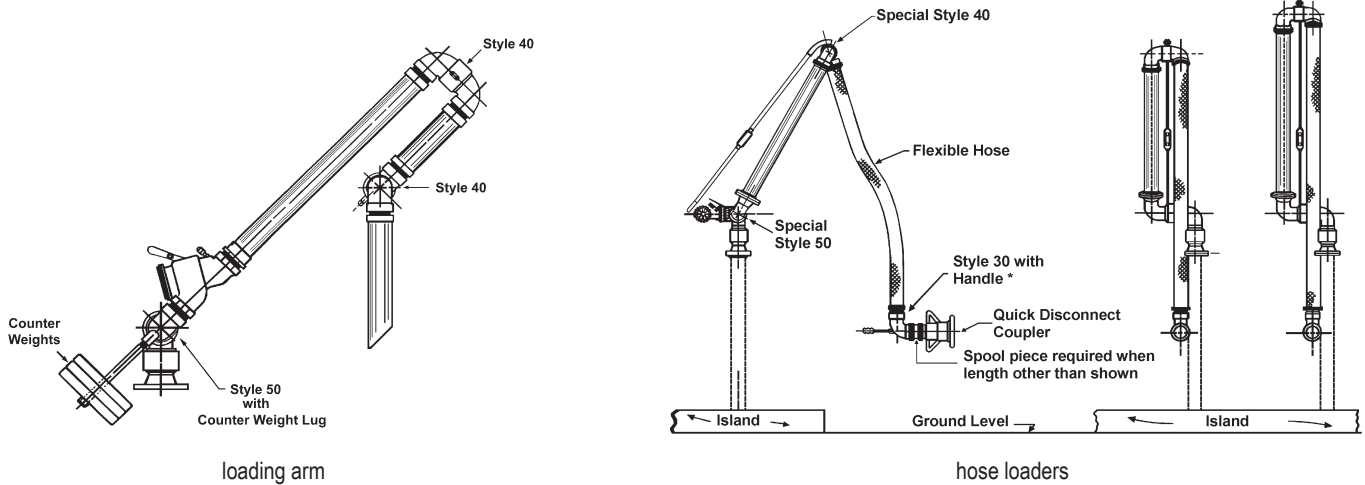

Safety Breakaway Couplings

Application:

- used most commonly on tank trucks, railcars and barges to limit the possibility of environmental impact and loss of product resulting from a break in a connection

Features:

- marine version - hose to hose
- industrial version - fixed point to hose
- coupling automatically senses an excessive load, closes the valves and disconnects
- high flow rate / low pressure drop
- female NPT is standard, optional ANSI / DIN flanges or male NPT are available
- working pressure: stainless steel **360 PSI** and aluminum (industrial version) **230 PSI** at ambient temperature (70°F)

Materials:

- industrial version: 316 stainless steel or aluminum
- marine version: 316 stainless steel
- Viton® is standard seal

Sizes:

- 2", 3", 4", 5", 6" and 8"



marine version



industrial version

Valves

Brass Ball Valves

Applications:

- controls the flow of crude oil and natural gas in various applications

Features:

- rated to 600 PSI WOG: 150 PSI saturated steam
- blow-out proof stems
- meets WW-V 35C, Type II Composition
- full and standard ports available, both repairable
- ball valve handle replacements available, call Dixon for information

Materials:

- body, balls and stems: brass
- handles and nuts: plated steel with vinyl sleeves
- glass-filled reinforced PTFE seats and stuffing box ring; stem seals and washers

Sizes:

- $\frac{1}{4}$ ", $\frac{3}{8}$ " and $\frac{1}{2}$ " in full port design
- $\frac{3}{4}$ ", 1", 1 $\frac{1}{4}$ ", 1 $\frac{1}{2}$ ", 2", 2 $\frac{1}{2}$ " and 3" in standard port design



Locking Handle Brass Ball Valves

Applications:

- controls the flow of crude oil and natural gas in various applications, from injection systems to blow-out prevention in wells

Features:

- rated to 600 PSI WOG: 150 PSI saturated steam
- blow-out proof stem
- stainless steel sliding lock mechanism secures handle in open or closed position; can be pad-locked open or closed
- full and standard ports available, both repairable

Materials:

- body and stems: brass
- ball: chrome-plated brass
- stem: RPTFE

Sizes:

- $\frac{1}{4}$ ", $\frac{3}{8}$ " and $\frac{1}{2}$ " in full port design
- $\frac{3}{4}$ ", 1", 1 $\frac{1}{4}$ ", 1 $\frac{1}{2}$ " and 2" in standard port design

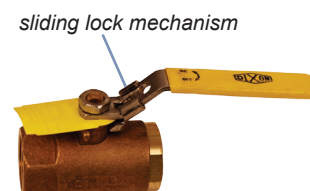

3-Way Diverting Ball Valves

Applications:

- controls or divert the flow of media in various applications, from injection systems to blow-out prevention in wells

Features:

- rated to 400 PSI WOG: 100 PSI saturated steam
- blow-out proof stem
- PTFE seats, seals, and thrust washer
- adjustable stem packing
- temperature range to 344°F
- standard port design

Materials:

- body: brass
- ball: chrome-plated brass

Sizes:

- $\frac{1}{2}$ ", $\frac{3}{4}$ ", 1", 1 $\frac{1}{4}$ ", 1 $\frac{1}{2}$ " and 2"



Locking Handle Stainless Steel Ball Valves

sliding lock mechanism



full port

sliding lock mechanism

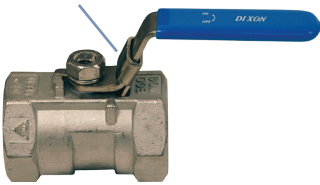

reduced port

Application:

- controls the flow of caustic and corrosive fluid in various oil field applications

Features:

- full port rated to 1000 PSI WOG: 100 PSI saturated steam
- reduced port rated to 800 PSI WOG: 100 PSI saturated steam
- blow-out proof stem design
- temperature range -20°F to 450°F
- full and standard ports available
- lockable

Materials:

- body, ball and stem: 316 stainless steel
- seat, joint gasket and thrust washer: PTFE

Sizes:

- 1/4", 3/8", 1/2", 3/4", 1", 1 1/4", 1 1/2" and 2" in reduced port and full port design

Ductile Iron Butterfly Valves



NOT RECOMMENDED FOR STEAM SERVICE

Application:

- controls flow of water, chemicals and sand slurry

Features:

- rated to 200 PSI
- will lock "open" or "closed"
- for use between two 150# flanges
- number of holes on the valve depends on the body size

Materials:

- body: ductile iron, ASTM A536
- disc: nickel plated ductile iron
- top and bottom stems: 416 stainless steel
- seat and stem seals: Buna-N
- bushing: PTFE

Sizes:

- 3", 4", 6" and 8"



Gate Valves

Applications:

- used for steam service in pipe lines or in other high temperature or pressure applications

Features:

- bolted bonnet
- female threaded ends
- ASTM A105, ANSI B120.1: class 800
- rated to 1975 PSI
- maximum temperature: 800°F

Material:

- body: forged steel

Sizes:

- 1/2", 3/4", 1", 1 1/4", 1 1/2" and 2"



Hydraulic Quick Disconnects

VEP & VEP-BOP Series Thread To Connect Flush Face

Application:

- used in a variety of drilling rig applications and hydraulic power units where the ability to connect and disconnect under pressure is necessary

Features:

- threaded, no spill design provides the ideal solution for high pressure, high impulse applications
- connect and disconnect under pressure
- patented valve retention system minimizes pressure drop and maximizes connection and pressure performance
- trivalent chrome plating provides superior corrosion resistance
- Blow-out prevention (BOP) version available. Fire tested and Lloyd's certified in accordance with API 16D.

Materials:

- coupler and nipple: steel
- dust cap & plug: aluminum body with stainless steel bead chain

Sizes:

- 1/4", 3/8", 1/2", 3/4", 1", 1 1/4", 1 1/2" and 2"

Interchange Data:

- Stucchi VEP/VEP-HD, DNP PST4/FSI, Holmbury HFT, Parker FET



VEP Series



VEP-BOP Series

WS & WS-BOP Series Heavy Duty Thread To Connect

Applications:

- extensively used in a variety of oilfield applications

Features:

- connect under residual pressure
- durable sleeve is cast using a process that provides improved surface finishes, tighter tolerances, and excellent repeatability
- heavy duty "spider" valve holder withstands surge flow and pressurized connections
- seals are easily field replaceable
- Blow-out prevention (BOP) version available. Fire tested and Lloyd's certified in accordance with API 16D.

Materials:

- coupler and nipple: steel or 316 stainless
- dust cap & plug: aluminum body with stainless steel bead chain

Sizes:

- 3/4", 1", 1 1/4", 1 1/2" and 2"

Interchange Data:

- Snap-Tite 75, Hydraulics Inc 5TV, Stucchi VOF, DNP VFF-HD, Faster OGV, Eaton FD85



WS Series

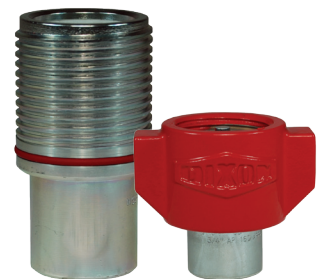

WS-BOP Series

Hydraulic Quick Disconnects

W-Series

7800 Wingstyle Interchange

Application:

- used to connect hydraulic lines on oilfield equipment such as tongs, swivels, and other drill rig applications

Features:

- threaded wing or hex sleeves enable easy connection and disconnection while under residual pressure
- O-ring connected marker is highly visible during connection and helps keep contaminants out of the threads while connected
- coupler has a tubular valve design to reduce pressure drop and turbulence while improving flow performance
- bulkhead mounting kits available
- flanged bonded seal prolongs coupling life and is integral in the reduction of spillage and air inclusion

Materials:

- coupler and nipple: brass, steel wing nut
- dust cap & plug: steel body with stainless steel bead chain
- nipple mounting flange: steel

Sizes:

- ¾", 1", 1¼" and 1½"

Interchange Data:

- Eaton 5100, Parker 6100, Snap-Tite 78, Safeway S51, Stucchi W



HT-Series

ISO 16028 Flush Face Interchange

Application:

- no-spill coupling used to connect hydraulic lines on construction equipment, hydraulic tools, and other hydraulic systems

Features:

- patented coupler retention system prevents valve stem ejection during surge flow and pressure spike conditions while maximizing flow performance
- high strength laser-cut valve guide in nipple improves valve stability while minimizing flow restriction
- designed to exceed 1,000,000 impulse cycles both connected and disconnect
- bulkhead mountable grooved sleeve for breakaway, multi-plate or blindmate installations
- easily rebuildable coupler and nipple

Materials:

- coupler and nipple: steel or 316 stainless
- dust cap & plug: elastomer

Sizes:

- ¼", ⅜", ½", ⅝", ¾", 1", 1½", and 2"

Interchange Data:

- Parker FEM, Eaton FD89, Stucchi FIRG/Series A, Faster FFH, Safeway FF49



Hydraulic Quick Disconnects

ST-Series Flush Face 71 Interchange

Application:

- use in hydraulic applications where a no-spill coupling with higher working pressures and rugged design is required

Features:

- flush face valve design minimizes air inclusion during connection and spillage during disconnection
- heavy duty construction for abusive applications
- bulkhead mountable grooved sleeve for breakaway, multi-plate or blindmate installations

Materials:

- coupler and nipple: steel or 316 stainless
- dust cap & plug: aluminum body with stainless steel bead chain

Sizes:

- ¼", ⅜", ½", ¾", 1" and 2"

Interchange Data:

- Snap-Tite 71-Series



T-Series 3000 High Pressure Thread To Connect Interchange

Application:

- designed for high pressure applications such as hydraulic rams and pumps where pressure up to 10,000 PSI is possible

Features:

- threaded sleeve allows connection and disconnection while coupler and/or nipple are under pressure
- urethane seal resists extrusion under high pressure
- ball valve and poppet valve styles available

Materials:

- coupler and nipple: steel or 316 stainless
- dust cap: steel body with stainless steel bead chain
- dust plug: steel body with elastomer lanyard

Sizes:

- ¼" and ⅜"

Interchange Data:

- Parker/Pioneer 3000, Enerpac C604, Stucchi IVHP, DNP PVM



Enerpac® is a registered trademark of the Enerpac Company

Hydraulic Quick Disconnects

H & H-BOP Series ISO 7241 Series B Industrial Hydraulic Series



H Series



H-BOP Series

Application:

- double shut-off coupling used in a wide variety of hydraulic applications where fluid transfer lines need to be connected and disconnected with minimal fluid loss

Features:

- variety of body and seal materials for versatility in a wide array of applications
- steel coupler sleeves and nipples are hardened to provide heavy duty performance and resist brinelling
- brass and BOP couplers have a redundant O-ring sealing system
- Blow-out prevention (BOP) version available. Fire tested and Lloyd's certified in accordance with API 16D.

Sizes:

- 1/8", 1/4", 3/8", 1/2", 3/4", 1", 1 1/4", 1 1/2" and 2 1/2"

Materials:

- coupler and nipple: steel, brass, 303 stainless or 316 stainless
- dust cap & plug: aluminum body with stainless steel bead chain, elastomer

Interchange Data:

- Parker 60, Hansen HK, Eaton FD45, Faster HNV, Stucchi IRB/IRBO/IRBX

K-Series ISO 7241 Series A 5600 Mobile General Purpose Series

Application:

- double shut-off coupling used in a wide variety of hydraulic applications where hoses need to be connected and disconnected with minimal fluid loss

Features:

- steel componentry is plated using ROHS compliant trivalent chrome
- heavy duty knurled sleeves are hardened to resist deformation and maximize service life
- nipples are hardened to resist brinelling

Materials:

- coupler and nipple: steel
- dust cap & plug: elastomer

Sizes:

- 1/4", 3/8", 1/2", 3/4", 1", 1 1/4", 1 1/2" and 2"

Interchange Data:

- Parker 6600, Eaton FD56 (5600), Faster ANV, Safeway S56, Stucchi BIR



V-Series

General Purpose H/IH Interchange

Application:

- general purpose coupling for hydraulic and pneumatic service

Features:

- compliant with MIL-C-51234
- available in single shut-off, double shut-off, or straight through valve configurations for a variety of applications
- wide array of materials and end configurations

Materials:

- coupler and nipple: steel, brass or 316 stainless
- dust cap & plug: aluminum body with stainless steel bead chain, elastomer

Sizes:

- 1/4", 3/8", 1/2", 3/4", 1", 1 1/4", 1 1/2" and 2"

Interchange Data:

- Snap-Tite H/IH, Faster TNV/TNL

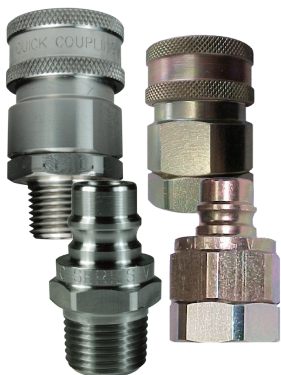

Hydraulic Adapters

• additional adapters and configurations available, call Dixon or visit dixonvalve.com for more information



45° male NPTF x female NPSM swivel



male 37° flare x male SAE O-ring



JIC male 37° flare x male NPTF



SAE 61 x male JIC



female NPTF x male NPTF branch tee



male flat face x male NPTF

Air & Water Utilities



Air King Couplings
couplers, ferrules and clamps



Pneumatic Couplers
air supply, testing equipment and blow guns



Filters, Regulators, & Lubricators
combination units, repair kits



Gauges
digital, liquid filled and dry



Fire Hose and Reels
nozzles, racks and safety equipment



PTFE Assemblies
hose, couplings and fittings

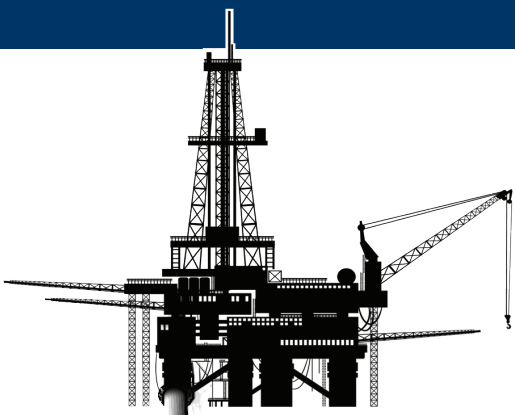

EXPLORATION/ PRODUCTION

Pet•ro•chem•i•cal

noun

Any chemical derived from petroleum or natural gas.

Many countries, many cultures, but the same Petrochemical Life Cycle applications using DIXON products for safe and reliable fluid transfer.

Popular brands include... Boss, Bayco, Holedall, King, and more...



TRANSPORTATION



REFINING



TRANSPORTATION

1



Exploration and Production

- Boss Low Pressure System Products
- Frac Fittings
- King Crimp System
- Hammer Unions
- Control Valves
- Holedall Couplings
- Tank Truck and Rail Car/API Fittings & Assemblies

2

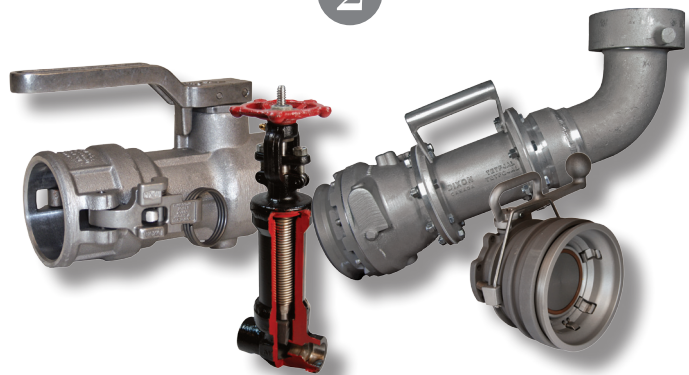

Refining

- Dry Break Couplings
- Cam & Groove
- Dry Disconnects
- Ground Joint Systems
- Valves
- API Fittings

THE PETROCHEMICAL LIFE CYCLE



Terminal to Retail

- Overfill Protection
- Loading/Unloading
- Adapters
- Vapor Elbows
- Swivels
- Tank Truck and Rack Fittings
- Nozzles



Scan for more information on the
petrochemical life cycle

Dixon is recognized as the premier manufacturer and supplier of hose fittings and accessories spanning a wide range of industrial uses. Dixon's range includes products for food, dairy processing, beverage and brewery, mobile tankers, mining, construction, chemical processing, petroleum, oilfields, refining and manufacturing.

dixonvalve.com • *Customer Service:* 877.963.4966



The Right Connection®

Dixon

800 High Street, Chestertown, MD 21620
fx: 800.283.4966



YouTube™



Dixon
Customer Service