

FLEXIBLE PRODUCTS FOR THE INDUSTRIAL AND HVAC INDUSTRIES



- RUBBER EXPANSION JOINTS
- STAINLESS STEEL BRAIDED CONNECTORS
- BRAIDED CONNECTORS FOR COPPER PIPE
- SEISMIC "V" LOOPS FOR SEISMIC & THERMAL
- SPECIAL HVAC CONNECTORS
- METAL EXPANSION JOINTS
- TEFLON® BELLOWS CONNECTORS
- FLUE DUCTS
- PIPE ALIGNMENT GUIDES
- TEFLON® HOSE ASSEMBLY



ENGINEERED FLEXIBLE PRODUCTS, INC

Where everything gets connected.

Engineered Flexible Products is your source for all types and styles of expansion joints and flexible connectors.

We offer all styles of braided connectors, including stainless steel and bronze braided hose assemblies. These braided assemblies control vibration and noise, and provide the ability to accommodate offset pipe motion.

For the industry's best option in absorbing noise and vibration from mechanical equipment such as pumps, chillers and air handlers, choose our rubber spherical expansion joints in single or double sphere style. They're also capable of taking up limited amounts of thermal pipe growth.

You'll learn about those products in this catalog—and more, including bellows pipe connectors, expansion compensators, externally pressurized expansion joints, PTFE bellows, and stainless steel bellows expansion joints. These items are available for a variety of pipe expansion applications and equipment connections.

EFP's Seismic "V" Loop configuration connectors are designed to be your solution for problems related to both seismic and thermal expansion. "V" Loops are available for steel or copper piping and a wide range of services, including mechanical, plumbing, and medical gases.

If you're looking for flexible connectors, expansion joints, or accessories, you don't need to look anywhere else—we offer all styles and all materials, from stainless steel and bronze to rubber and PTFE. In many cases, we can even offer a combination of materials that will customize the product to meet your specific needs.

EFP products are marketed through an organization of manufacturers representatives, industrial PVF distributors and equipment distributors throughout the United States and Canada. These customers stock a wide variety of our standard products. We provide rapid backup inventory of these products along with other products found in this catalog. We also pride ourselves on the ability to fabricate special design connectors and expansion joints according to customer specification.

Give us a call at 1-877-769-8262 to discuss any of the items in this catalog, as well as any of your special piping needs. Our vast experience of problem solving and our extensive inventory means you'll get the right answers, and the right products, when you need them.

Table of Contents



4

RUBBER EXPANSION JOINTS

Rubber Spheres

301 Single Sphere, 302 Double Sphere

303 Union Connectors

9

STAINLESS STEEL BRAIDED CONNECTORS

PCS-MMT Threaded Connectors

PCS-FLG Flanged Connectors

PCS-GG Grooved, PCS-GF Groove & Flange Connectors

CRPCS Reducing Flanged Pump Connectors

15

BRAIDED CONNECTORS FOR COPPER PIPE

PCB-BRSW & PCS-BRMP Bronze Braided Connectors

Special Metal Hose Assemblies

19

SEISMIC "V" LOOPS FOR SEISMIC & THERMAL

26

SPECIAL HVAC CONNECTORS

Special HVAC Connectors

Expansion Compensators

Bellows Pump Connectors

28

METAL EXPANSION JOINTS

Externally Pressurized Expansion Joints

Series EP Singles 150# & 300#, Series EP Dual 150# & 300#

Low Corr

High Corr

32

TEFLON® BELLOWS CONNECTORS

"Tef-Flex" Style 442 2-Convolute Flexible Coupling

"Tef-Flex" Style 443 3-Convolute Expansion Joint

33

FLUE DUCTS

34

PIPE ALIGNMENT GUIDES

Series PG Standard Pipe Alignment Guides

36

TEFLON® HOSE ASSEMBLY

38

PLANNING GUIDES

TEFLON® is a registered trademark of E.I. duPont de Nemours Co.

RUBBER SPHERE EXPANSION JOINTS

301 & 302 Sphere Flanged Connectors



“The industry’s best option for vibration and noise reduction.”

Precision molded Sphere connectors will perform double duty as a vibration elimination pump connector, or as an expansion joint absorbing pipe movements.

Sphere connectors are perfect for HVAC or industrial applications where a flexible connector is needed to absorb axial, transverse, or angular pipe movements. Sphere rubber connectors are also superior to braided metal connectors for absorbing vibration and noise generated by mechanical equipment.

Sphere connectors are precision molded in hydraulic presses. The spherical design insures that internal pressures are exerted in all directions, distributing the forces evenly over a large area. The spherical design acts as a free-flowing arch, reducing turbulence and growth due to pressure thrust forces.

These connectors are manufactured with a high-quality EPDM rubber tube and cover, and nylon tire cord reinforcing. Special elastomers such as Neoprene, Nitrile, Hypalon, and Buytl are also available. The standard EPDM material is superior to competitive connectors made of Neoprene due to their higher temperature resistance and physical properties. Plated steel floating flanges are recessed to engage the rubber beaded end of the expansion joint and rotate easily for speed of installation.

Style 301 single sphere connectors are ideal for absorbing small stress motions and absorbing the noise and vibration emitted by mechanical equipment. The face-to-face dimensions of these single sphere connectors match the corresponding dimensions of spool type expansion joints, facilitating direct replacements. This short face-to-face dimension translates to economy of space in the piping system and ease of handling and installation.

Style 302 double sphere connectors are similar in construction to the single sphere style, but with a second sphere to provide even more pipe movement absorbing capability and even greater efficiency for noise and vibration control. In fact, Style 302 connectors offer the industry’s best option for vibration reduction—up to 98%, depending on pressure and frequency. A plated steel external root ring surrounds the connector between the spheres, preventing ballooning or swelling under pressure.

Control units are recommended for use on Sphere connectors when it is not possible to install solid anchors in the piping system. Although it is theoretically possible to pre-elongate spherical connectors to avoid the effects of extension due to pressure thrust forces, EFP does not recommend this practice in lieu of anchors and control units due to the unpredictability of subsequent pressure spikes and system pressure tests.

Sphere 301 & 302 connectors are manufactured to meet or exceed the pressure, movement, and dimensional ratings of the Rubber Expansion Joint Division, Fluid Sealing Association.

*** Other styles and sizes are readily available.**

***Maximum Operating Temperature**

Temperature (°F)	Maximum Pressure PSI
	12" & Smaller
170°	225
180°	200
190°	175
200°	150
210°	125
220°	100
230°	75

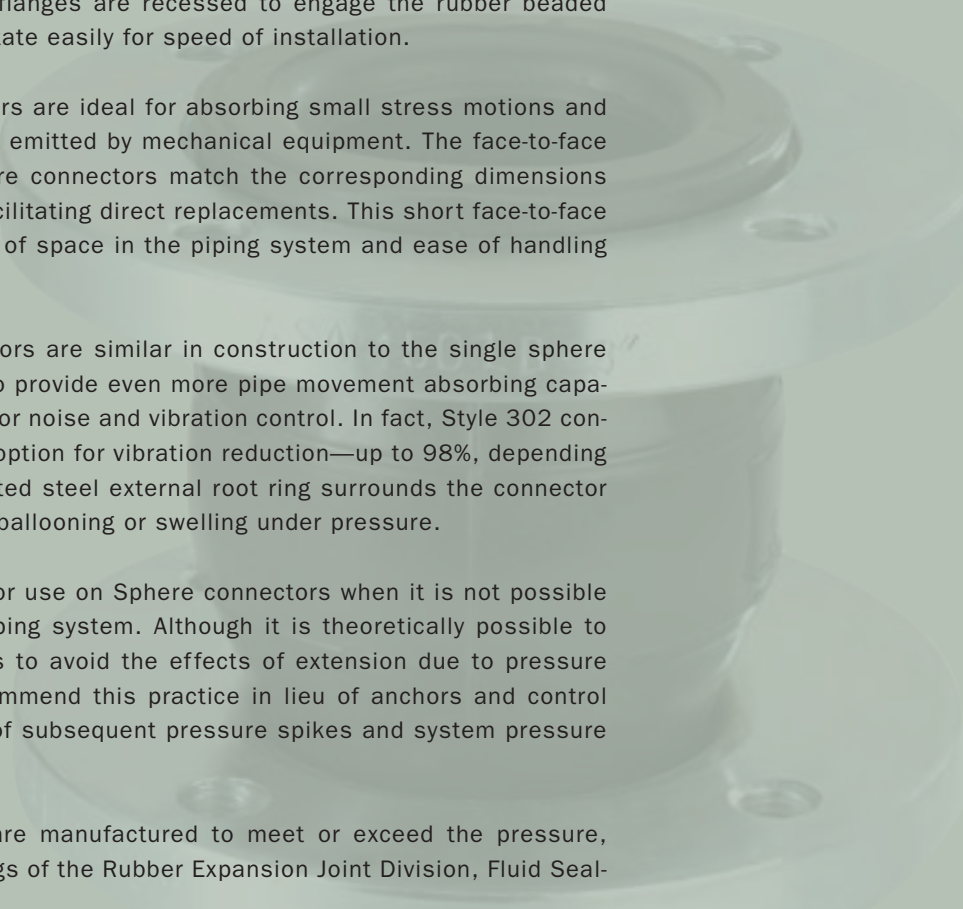

**EPDM body with 150# drilled flanges provides up to 225 PSI and temperatures up to 230° F**

MODEL #	JOINT SIZE I.D. (IN)	FACE-TO-FACE (IN)	MOVEMENT CAPABILITY			ANGULAR (DEGREES)	GROSS WT. (LBS)
			COMPRESSION (IN)	ELONGATION (IN)	LATERAL (IN)		
301EE0200	2	6	1/2	3/8	1/2	20	12
301EE0250	2-1/2	6	1/2	3/8	1/2	17	13
301EE0300	3	6	1/2	3/8	1/2	14	14
301EE0400	4	6	5/8	3/8	1/2	14	18
301EE0500	5	6	5/8	3/8	1/2	11	23
301EE0600	6	6	5/8	3/8	1/2	9	27
301EE0800	8	6	5/8	3/8	1/2	7	40
301EE1000	10	8	3/4	1/2	3/4	7	57
301EE1200	12	8	3/4	1/2	3/4	6	83

Neoprene body with 150# drilled flanges provides up to 225 PSI and temperatures up to 230° F

MODEL #	JOINT SIZE I.D. (IN)	FACE-TO-FACE (IN)	MOVEMENT CAPABILITY			ANGULAR (DEGREES)	GROSS WT. (LBS)
			COMPRESSION (IN)	ELONGATION (IN)	LATERAL (IN)		
301NN0200	2	6	1/2	3/8	1/2	20	12
301NN0250	2-1/2	6	1/2	3/8	1/2	17	13
301NN0300	3	6	1/2	3/8	1/2	14	14
301NN0400	4	6	5/8	3/8	1/2	14	18
301NN0500	5	6	5/8	3/8	1/2	11	23
301NN0600	6	6	5/8	3/8	1/2	9	27
301NN0800	8	6	5/8	3/8	1/2	7	40
301NN1000	10	8	3/4	1/2	3/4	7	57
301NN1200	12	8	3/4	1/2	3/4	6	83

Butyl body with 150# drilled flanges provides up to 225 PSI and temperatures up to 230° F

MODEL #	JOINT SIZE I.D. (IN)	FACE-TO-FACE (IN)	MOVEMENT CAPABILITY			ANGULAR (DEGREES)	GROSS WT. (LBS)
			COMPRESSION (IN)	ELONGATION (IN)	LATERAL (IN)		
301BB0200	2	6	1/2	3/8	1/2	20	12
301BB0250	2-1/2	6	1/2	3/8	1/2	17	13
301BB0300	3	6	1/2	3/8	1/2	14	14
301BB0400	4	6	5/8	3/8	1/2	14	18
301BB0500	5	6	5/8	3/8	1/2	11	23
301BB0600	6	6	5/8	3/8	1/2	9	27
301BB0800	8	6	5/8	3/8	1/2	7	40
301BB1000	10	8	3/4	1/2	3/4	7	57
301BB1200	12	8	3/4	1/2	3/4	6	83

Nitrile body with 150# drilled flanges provides up to 225 PSI at temperatures up to 230° F

MODEL #	JOINT SIZE I.D. (IN)	FACE-TO-FACE (IN)	MOVEMENT CAPABILITY			ANGULAR (DEGREES)	GROSS WT. (LBS)
			COMPRESSION (IN)	ELONGATION (IN)	LATERAL (IN)		
301NP0200	2	6	1/2	3/8	1/2	20	12
301NP0250	2-1/2	6	1/2	3/8	1/2	17	13
301NP0300	3	6	1/2	3/8	1/2	14	14
301NP0400	4	6	5/8	3/8	1/2	14	18
301NP0500	5	6	5/8	3/8	1/2	11	23
301NP0600	6	6	5/8	3/8	1/2	9	27
301NP0800	8	6	5/8	3/8	1/2	7	40
301NP1000	10	8	3/4	1/2	3/4	7	57
301NP1200	12	8	3/4	1/2	3/4	6	83

Warning: Control units must be used to protect this part from excessive movement if piping is not properly anchored. Normal precautions should be taken to make sure these parts are installed correctly and inspected regularly. Precautions should be taken to protect personnel in the event of leakage or splash.



302 Double Sphere Flanged Connectors

RUBBER SPHERE EXPANSION JOINTS

EPDM body with 150# drilled flanges provides up to 225 PSI and temperatures up to 230° F

MODEL #	JOINT SIZE I.D. (IN)*	FACE-TO-FACE (IN)*	MOVEMENT CAPABILITY				SPRING RATE (LBS./IN.)	EFF. AREA (IN. SQ.)	GROSS WT. (LBS)
			COMPRESSION (IN)	ELONGATION (IN.)	LATERAL (IN)	ANGULAR (DEGREES)			
302EE0200	2	7	2	1.188	1.75	45	160	6	9
302EE0250	2.5	7	2	1.188	1.75	43	310	10	13
302EE0300	3	7	2	1.188	1.75	38	320	11	14
302EE0400	4	9	2	1.375	1.56	34	450	20	20
302EE0500	5	9	2	1.375	1.56	29	360	32	24
302EE0600	6	9	2	1.375	1.56	25	760	43	30
302EE0800	8	13	2.375	1.375	1.375	19	1030	66	44
302EE1000	10	13	2.375	1.375	1.375	15	680	101	65
302EE1200	12	13	2.375	1.375	1.375	13	950	154	95

Neoprene body with 150# drilled flanges provides up to 225 PSI and temperatures up to 230° F

MODEL #	JOINT SIZE I.D. (IN)*	FACE-TO-FACE (IN)*	MOVEMENT CAPABILITY				SPRING RATE (LBS./IN.)	EFF. AREA (IN. SQ.)	GROSS WT. (LBS)
			COMPRESSION (IN)	ELONGATION (IN.)	LATERAL (IN)	ANGULAR (DEGREES)			
302NN0200	2	7	2	1.188	1.75	45	160	6	9
302NN0250	2.5	7	2	1.188	1.75	43	310	10	13
302NN0300	3	7	2	1.188	1.75	38	320	11	14
302NN0400	4	9	2	1.375	1.56	34	450	20	20
302NN0500	5	9	2	1.375	1.56	29	360	32	24
302NN0600	6	9	2	1.375	1.56	25	760	43	30
302NN0800	8	13	2.375	1.375	1.375	19	1030	66	44
302NN1000	10	13	2.375	1.375	1.375	15	680	101	65
302NN1200	12	13	2.375	1.375	1.375	13	950	154	95

Butyl body with 150# drilled flanges provides up to 225 PSI and temperatures up to 230° F

MODEL #	JOINT SIZE I.D. (IN)*	FACE-TO-FACE (IN)*	MOVEMENT CAPABILITY				SPRING RATE (LBS./IN.)	EFF. AREA (IN. SQ.)	GROSS WT. (LBS)
			COMPRESSION (IN)	ELONGATION (IN.)	LATERAL (IN)	ANGULAR (DEGREES)			
302BB0200	2	7	2	1.188	1.75	45	160	6	9
302BB0250	2.5	7	2	1.188	1.75	43	310	10	13
302BB0300	3	7	2	1.188	1.75	38	320	11	14
302BB0400	4	9	2	1.375	1.56	34	450	20	20
302BB0500	5	9	2	1.375	1.56	29	360	32	24
302BB0600	6	9	2	1.375	1.56	25	760	43	30
302BB0800	8	13	2.375	1.375	1.375	19	1030	66	44
302BB1000	10	13	2.375	1.375	1.375	15	680	101	65
302BB1200	12	13	2.375	1.375	1.375	13	950	154	95

Nitrile body with 150# drilled flanges provides up to 225 PSI and temperatures up to 230° F

MODEL #	JOINT SIZE I.D. (IN)*	FACE-TO-FACE (IN)*	MOVEMENT CAPABILITY				SPRING RATE (LBS./IN.)	EFF. AREA (IN. SQ.)	GROSS WT. (LBS)
			COMPRESSION (IN)	ELONGATION (IN.)	LATERAL (IN)	ANGULAR (DEGREES)			
302NP0200	2	7	2	1.188	1.75	45	160	6	9
302NP0250	2.5	7	2	1.188	1.75	43	310	10	13
302NP0300	3	7	2	1.188	1.75	38	320	11	14
302NP0400	4	9	2	1.375	1.56	34	450	20	20
302NP0500	5	9	2	1.375	1.56	29	360	32	24
302NP0600	6	9	2	1.375	1.56	25	760	43	30
302NP0800	8	13	2.375	1.375	1.375	19	1030	66	44
302NP1000	10	13	2.375	1.375	1.375	15	680	101	65
302NP1200	12	13	2.375	1.375	1.375	13	950	154	95

*For larger sizes, contact us. **Warning:** Control units must be used to protect this part from excessive movement if piping is not properly anchored. Normal precautions should be taken to make sure these parts are installed correctly and inspected regularly. Precautions should be taken to protect personnel in the event of leakage or splash.

RUBBER SPHERE EXPANSION JOINTS

303 Double Sphere Female Union Connectors

Style 303 female union connectors are ideal for isolating small diameter piping from vibrating mechanical equipment.

In smaller size applications where threaded connectors are normally used, 303 double sphere union connectors will accommodate both pipe motions and vibration. 303 connectors will provide up to 7/8" of axial compensation, as well as impressive ratings for lateral and angular deflection. The Neoprene or EPDM rubber body construction is also far superior to metallic connectors for eliminating noise and vibration generated by equipment such as pumps, chillers and air handlers. These connectors are extremely versatile and can be used in a variety of services, and are available in designs to handle up to 150 PSIG and temperatures up to 200° F.

Sphere expansion joints are precision molded in hydraulic presses. The spherical design insures that internal pressures are exerted in all directions, distributing the forces evenly over a large area. The spherical design acts as a free-flowing arch, reducing turbulence and growth due to pressure thrust forces.

Style 303 Sphere connectors are constructed with a high-quality Neoprene or EPDM tube and cover and nylon tire cord reinforcing.

Style 303 EPDM connectors offer high-temperature EPDM rubber for tube and cover construction. Galvanized ductile iron threaded female union ends are standard. Special cable restraint attachments surround each end to prevent the connector from over-extending due to pressure thrust. A steel body ring encircles the rubber between the spheres to provide stability under pressure.

***Other styles and sizes are readily available.**

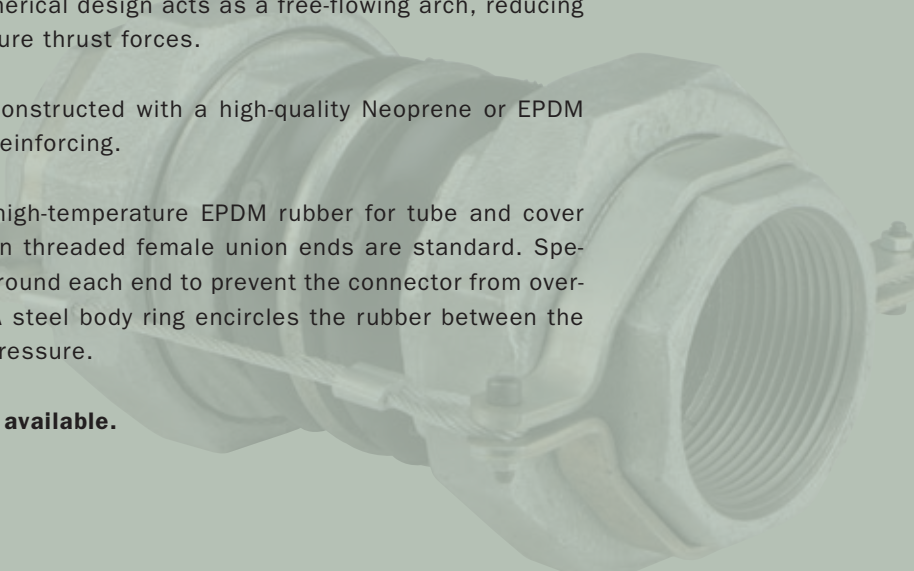

Double Sphere Union 303 Series

Double Sphere Unions

MODEL #	JOINT SIZE I.D. (IN)*	FACE-TO-FACE (IN)*	SPRING RATE (LBS./IN.)	EFF. AREA (IN. SQ.)	GROSS WT. (LBS)
3030075	3/4	8"	94	3	2
3030100	1	8"	110	3	3
3030125	1 - 1/4	8"	130	4	4
3030150	1 - 1/2	8"	143	5	5
3030200	2	8"	160	6	6
3030250	2 - 1/2	8"	310	10	8

Pressure/Temp: 150 PSI at 170° F.
 Compression: Up to 7/8"
 Elongation: Up to 3/16-in.
 Lateral movement: Up to 7/8"
 Angular movement: Up to 32 degrees

* For larger sizes, contact us



Spool Type 200 Series Hand Built

Available in one, two or three arches, the Spool Type joint has flanges integral with the body and employs metal retaining rings. The standard flanges mate with 125/150# flanges. Its body is constructed with high strength fabric.

Multiple arches are available to handle greater movements. To prevent the collection of solid materials in the arch, a soft rubber filler can be supplied. Filler reduces normal movement by up to 50%.

Available in many different rubber compounds and combinations of rubber compounds.

Custom, non-standard lengths and special flanges are available.

Warning: Control units must be used to protect this part from excessive movement if piping is not properly anchored. Normal precautions should be taken to make sure these parts are installed correctly and inspected regularly. Precautions should be taken to protect personnel in the event of leakage or splash. us.

*** For larger sizes, contact us.**

200 Series Spool Type

MODEL #	JOINT SIZE I.D. (IN)*	MIN. FACE-TO-FACE (IN)*	MOVEMENT CAPABILITIES				PRESSURE PSI (LBS/SQ IN) @ 70° F	VACUUM (IN OF HG)
			COMPRESSION (IN)	ELONGATION (IN.)	LATERAL (IN)	ANGULAR (DEGREES)		
200HT0200	2	6	1.40	.70	.60	34	200	26"
200HT0250	2-1/2	6	1.40	.70	.60	27	200	26"
200HT0300	3	6	1.40	.70	.60	23	200	26"
200HT0400	4	6	1.40	.70	.60	18	200	26"
200HT0500	5	6	1.40	.70	.60	15.2	190	26"
200HT0600	6	6	1.40	.70	.60	12.8	190	26"
200HT0800	8	6	1.40	.70	.60	9.7	190	26"
200HT1000	10	8	1.60	.80	.80	9.1	190	26"
200HT1200	12	8	1.60	.80	.80	7.6	190	26"
200HT1400	14	8	1.60	.80	.80	6.5	130	26"
200HT1600	16	8	1.60	.80	.80	5.7	115	26"
200HT1800	18	8	1.60	.80	.80	5.1	115	26"
200HT2000	20	8	1.60	.80	.80	5.1	115	26"
200HT2400	24	10	2.00	1.0	1.0	4.3	100	26"

Concentric Reducer 201

MODEL #	PIPE SIZE TO PIPE SIZE (IN)	MIN. FACE-TO-FACE (IN)*	MOVEMENT CAPABILITIES				WEIGHT W/ RINGS
			COMPRESSION (IN)*	ELONGATION (IN.)	LATERAL (IN)	ANGULAR (DEGREES)	
201RC2x1x6	2 x 1	6	.5	.25	.5	18.4	8
201RC2x1.5x6	2 x 1.5	6	.5	.25	.5	15.9	8
201RC2.5x1.5x6	2.5 x 1.5	6	.5	.25	.5	14.1	10
201RC2.5x2x6	2.5 x 2	6	.5	.25	.5	12.5	11
201RC3x1.5x6	3 x 1.5	6	.5	.25	.5	12.5	11
201RC3x2x6	3 x 2	6	.5	.25	.5	11.3	12
201RC3x2.5x6	3 x 2.5	6	.5	.25	.5	10.3	13
201RC4x2x6	4 x 2	6	.5	.25	.5	9.5	15
201RC4x2.5x6	4 x 2.5	6	.5	.25	.5	8.7	16
201RC4x3x6	4 x 3	6	.5	.25	.5	8.1	18
201RC5x3x6	5 x 3	6	.5	.25	.5	7.1	17
201RC5x4x6	5 x 4	6	.5	.25	.5	6.3	18
201RC6x2x8	6 x 2	8	.5	.25	.5	7.1	18
201RC6x2.5x6	6 x 2.5	6	.5	.25	.5	6.7	19
201RC6x3x6	6 x 3	6	.5	.25	.5	6.3	19
201RC6x4x6	6 x 4	6	.5	.25	.5	5.7	20
201RC6x4x6	6 x 4	8	.5	.25	.5	5.7	24
201RC6x5x6	6 x 5	6	.5	.25	.5	5.2	26
201RC8x3x6	8 x 3	6	.75	.375	.5	7.8	26
201RC8x4x6	8 x 4	6	.75	.375	.5	7.1	28
201RC8x4x8	8 x 4	8	.75	.375	.5	7.1	30
201RC8x5x6	8 x 5	6	.75	.375	.5	6.6	31
201RC8x6x6	8 x 6	6	.75	.375	.5	6.1	33
201RC8x6x8	8 x 6	8	.75	.375	.5	6.1	34
201RC10x5x8	10 x 5	8	.75	.375	.5	5.7	36
201RC10x6x8	10 x 6	8	.75	.375	.5	5.4	38
201RC10x8x6	10 x 8	6	.75	.375	.5	4.8	40
201RC10x8x8	10 x 8	8	.75	.375	.5	4.8	43
201RC12x6x8	12 x 6	8	.75	.375	.5	4.8	48
201RC12x8x6	12 x 8	6	.75	.375	.5	4.3	50
201RC12x8x8	12 x 8	8	.75	.375	.5	4.3	53
201RC12x10x8	12 x 10	8	.75	.375	.5	3.9	59



STAINLESS STEEL BRAIDED CONNECTORS

PCS-MMT & PCS-FLG Series Pump Connectors

Style PCS stainless steel braided pump connectors are the standard of the HVAC industry for a rugged, versatile flex product to connect piping to vibrating mechanical equipment.

PCS stainless steel connectors combine 300 series corrugated stainless steel hose and braid with weld-on carbon steel end fittings for a high pressure assembly. Standard connectors with stainless steel end fittings are also available. **EFP** starts with a high corr-count inner hose for greater flexibility and better noise and vibration control efficiency. A tightly woven stainless steel braid provides high pressure ratings, even in high temperature heating water applications. In sizes 8" and larger, **EFP** provides braided-braid reinforcing. This style of premium braiding translates to better strength and safety—vital considerations in large size pipelines where pressure thrust forces are greatest.

Style PCS-MMT threaded and PCS-FLG flanged are made to traditional industry standard overall lengths. These connectors are designed to provide good efficiency for noise and vibration control.

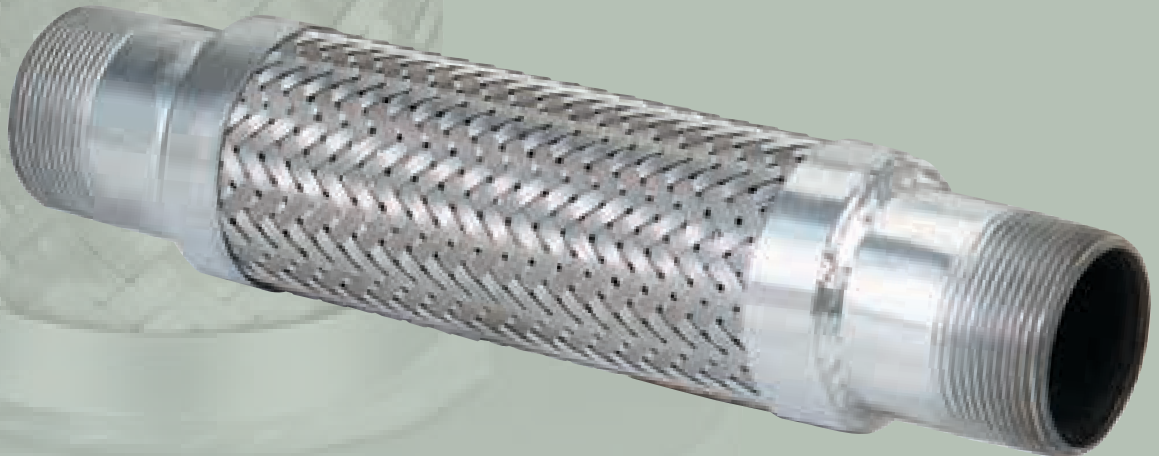

Standard Sizes Ready for Immediate Shipment

PRESSURE @ 70° F

SIZE	S.S.	BRONZE
1/2" x 6-1/2"	1300	500
3/4" x 7"	750	370
1" x 8"	605	250
1-1/4" x 8-1/2"	570	200
1-1/2" x 9"	525	190
2" x 10-1/2"	455	170
2-1/2" x 12"	345	

Correction Factors For Elevated Temperatures; Apply to pressure rating for elevated temperature

MATERIAL

TEMP F	STAINLESS	STEEL	MONEL	BRONZE
70	1.00	1.00	1.00	1.00
150	.97	.99	.93	.92
200	.94	.97	.90	.89
250	.92	.96	.87	.86
300	.88	.93	.83	.83
350	.86	.91	.82	.81
400	.83	.87	.79	.78
450	.81	.86	.77	.75
500	.78	.81	.73	
600	.77	.74	.72	
700	.76	.66	.71	
800	.68	.52	.70	
900	.62			
1000	.60			
1100	.58			
1200	.53			
1300	.46			
1400	.44			
1500	.37			



PCS-FLG Flanged – Standard Stock Assemblies

Standard Sizes Ready for Immediate Shipment

PIPE SIZE	LENGTH	PRESSURE @ 70° F
2"	9"	455
2.5"	9"	345
3"	9"	389
4"	9"	300
5"	11"	220
6"	11"	200
8"	12"	190
10"	13"	150
12"	14"	125
14"	14"	105

Correction Factors For Elevated Temperatures; Apply to pressure rating for elevated temperature, same as above.



STAINLESS STEEL BRAIDED CONNECTORS

CRPCS Flanged Reducing Connectors



EFF's CRPCS connectors are a material and labor saving device designed to provide vibration and noise isolation when connected between piping and vibrating equipment. These special connectors are intended to facilitate a reduction in pipe size when connecting to mechanical equipment. They are normally installed on the discharge side of HVAC pumps. Since CRPCS connectors incorporate a reduced size flange on one side, it eliminates having to install both a straight flex connector and a pipe reducer. CRPCS connectors utilize series 300 stainless steel hose and braid, carbon steel flanges, and carbon steel bell reducers. Longer length connectors are available on request to provide additional lateral deflection and increased vibration control efficiency.

EFF also maintains a large inventory of flexible stainless steel connectors in groove x groove, groove x flange, besides the above mentioned reducing styles.



CRPCS Flanged Reducing Connectors

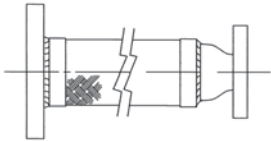

CRPCS Flanged Reducing Connectors

SIZES (IN)	PART #	OAL (IN)	HOSE SIZE (IN)	LIVE LENGTH (IN)	STATIC BEND RADIUS (IN)	# OF BRAIDS	WORKING PRESSURE (PSIG)	BURST PRESSURE (PSIG)	APPROX. WGHT (LBS)
2-1/2 x 2	CRPCS-2520-FLG	13	2-1/2	6.25	6.5	1	387	1548	8.0
3 x 2	CRPCS-3020-FLG	13	3	6.25	8.5	1	316	1264	8.5
3 x 2-1/2	CRPCS-3025-FLG	13	3	5.75	8.5	1	316	1264	9.0
4 x 2	CRPCS-4020-FLG	13	4	5.75	11.0	1	232	927	17.0
4 x 2-1/2	CRPCS-4025-FLG	13	4	5.75	11.0	1	232	927	19.0
4 x 3	CRPCS-4030-FLG	13	4	5.75	11.0	1	232	927	22.0
5 x 2-1/2	CRPCS-5025-FLG	16	5	7.63	14.0	1	191	764	26.0
5 x 3	CRPCS-5030-FLG	16	5	7.63	14.0	1	191	764	27.0
5 x 4	CRPCS-5040-FLG	16	5	7.63	14.0	1	191	764	29.0
6 x 3	CRPCS-6030-FLG	17	6	8.38	16.0	1	165	660	33.0
6 x 3	CRPCS-6040-FLG	17	6	8.38	16.0	1	165	660	35.0
6 x 5	CRPCS-6050-FLG	17	6	8.00	16.0	1	165	660	39.0
8 x 4	CRPCS-8040-FLG	18	8	8.38	19.0	1	235	940	49.0
8 x 5	CRPCS-8050-FLG	18	8	8.25	19.0	1	235	940	55.0
8 x 6	CRPCS-8060-FLG	18	8	8.25	19.0	1	235	940	64.0
10 x 6	CRPCS-1060-FLG	18	10	7.25	24.0	1	230	918	84.0
10 x 8	CRPCS-1080-FLG	18	10	7.25	24.0	1	230	918	89.0
12 x 10	CRPCS-1210-FLG	20	12	8.00	28.0	1	160	640	128.0

* Other sizes available upon request.

STAINLESS STEEL BRAIDED CONNECTORS

Custom Connectors

EFP stainless steel braided hose is available in a variety of custom styles.

- Choose your overall length
- Select either single braid or double braid
- Fitting material can be carbon steel, stainless steel, or copper
- End fitting styles:
 - Sch 40 or Sch 80 pipe threads
 - Hex wrenching surface
 - Beveled weld ends
 - Plate, raised-face, and weld neck flanges
- Floating flanges
- 150#, 300#, or 600# drill patterns
- 150# or 300# unions
- JIC
- Grooved
- Copper sweat (tube), copper hex male NPT, copper union
- Sanitary flanges



COMMON FITTINGS

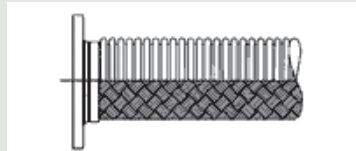

Steel Plate Flange

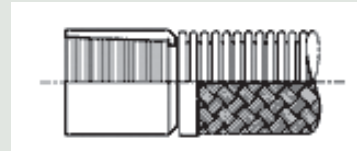

Female Pipe Coupling

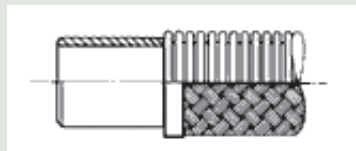

Weld Nipple/37-1/2" Bevel

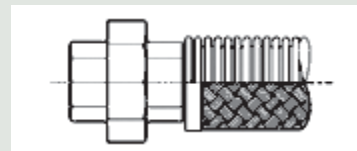

Female Union

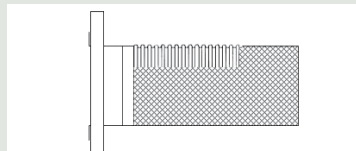

Vanstone or Floating Flange

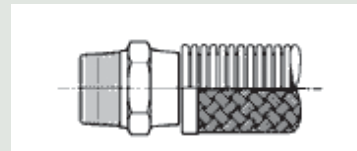

Male Hex Nipple

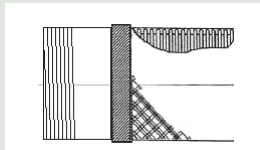

Male Pipe Nipple

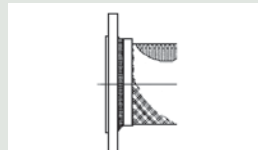

Raised Face Flange

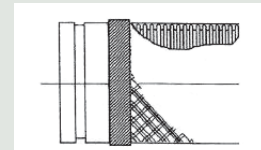

Groove



T-321 Stainless Steel Annular Corrugated Hose

Nom I.D. (in.)	Braid Layers	Nom. O.D. (in.)	Maximum Pressure @ 70° F (PSIG) ^a			Centerline Bend Radius (in.)		Weight per Foot (lb.)
			Working	Test	Nominal Burst	Dynamic	Static Bend	
1/4"	0	.48	180	270	--			.09
	1	.57	2116	3844	10250	5.00	1.00	.17
	2	.64	3125	4687	12500			.26
3/8"	0	.63	100	150	--			.13
	1	.74	1501	2251	6004	5.50	1.25	.25
	2	.81	2401	3602	9604			.36
1/2"	0	.82	80	120	--			.23
	1	.89	1075	1613	4301	6.00	1.50	.34
	2	.96	1720	2580	6880			.46
3/4"	0	1.12	70	105	--			.39
	1	1.28	792	1188	3168	8.00	2.25	.59
	2	1.35	1267	1901	5069			.79
1"	0	1.51	40	60	--			.53
	1	1.58	571	857	2285	9.00	2.75	.75
	2	1.65	914	1370	3654			.98
1-1/4"	0	1.85	25	38	--			.76
	1	1.93	531	797	2125	10.50	3.50	1.07
	2	2.20	850	1274	3398			1.37
1-1/2"	0	2.19	20	30	--			.84
	1	2.28	472	708	1887	12.00	4.00	1.23
	2	2.37	755	1133	3021			1.63
2"	0	2.60	15	23	--			.90
	1	2.72	516	774	2064	15.00	5.00	1.52
	2	2.84	826	1239	3302			2.14
2-1/2"	0	3.23	12	18	--			1.16
	1	3.33	387	581	1548	20.00	8.00	1.86
	2	3.43	619	929	2477			2.56
3"	0	3.78	10	15	--			1.21
	1	3.88	316	474	1264	22.00	9.00	2.00
	2	3.98	506	758	2022			2.80
4"	0	4.85	8	12	--			1.69
	1	4.98	232	348	927	27.00	13.00	2.68
	2	5.10	371	557	1485			3.86
5"	0	5.90	6	9	--			2.50
	1	6.03	191	286	764	31.00	18.00	3.75
	2	6.15	306	458	1222			5.0
6"	0	6.87	5	8	--			3.47
	1	7.10	165	247	660	36.00	19.00	4.75
	2	7.33	264	396	1056			6.04
8"	0	9.09	6	9	--			5.56
	1	9.19	234	350	934	40.00	20.00	9.44
	2	9.28	374	561	1495			13.36
10"	0	11.18	5	8	--			6.80
	1	11.32	230	344	918	50.00	25.00	12.90
	2	11.45	367	551	1469			19.00
12"	0	13.23	3	5	--			9.02
	1	13.37	161	241	643	60.00	30.00	14.83
	2	13.50	257	386	1029			20.64
14"	0	14.70	3	5	--			14.10
	1	14.84	119	178	476	70.00	35.00	21.70
	2	14.98	190	285	760			29.30

STAINLESS STEEL BRAIDED CONNECTORS



Stainless Steel Annular Corrugated Hose

STAINLESS STEEL BRAIDED CONNECTORS

T-316 Stainless Steel Annular Corrugated Hose

Nom I.D. (in.)	Braids Layers	Nom. O.D. (in.)	Maximum Pressure @ 70° F (PSIG) ^a			Centerline Bend Radius (in.)		Weight per Foot (lb.)
			Working	Test	Nominal Burst	Dynamic	Static Bend	
1/4"	0	.48	180	270	--			.09
	1	.57	2116	3844	10250	5.00	1.00	.17
	2	.64	3125	4687	12500			.26
3/8"	0	.63	100	150	--			.13
	1	.74	1501	2251	6004	5.50	1.25	.25
	2	.81	2401	3602	9604			.36
1/2"	0	.82	80	120	--			.23
	1	.89	1075	1613	4301	6.00	1.50	.34
	2	.96	1720	2580	6880			.46
3/4"	0	1.12	70	105	--			.39
	1	1.28	792	1188	3168	8.00	2.25	.59
	2	1.35	1267	1901	5069			.79
1"	0	1.51	40	60	--			.53
	1	1.58	571	857	2285	9.00	2.75	.75
	2	1.65	914	1370	3654			.98
1-1/4"	0	1.85	25	38	--			.76
	1	1.93	531	797	2125	10.50	3.50	1.07
	2	2.20	850	1274	3398			1.37
1-1/2"	0	2.19	20	30	--			.84
	1	2.28	472	708	1887	12.00	4.00	1.23
	2	2.37	755	1133	3021			1.63
2"	0	2.60	15	23	--			.90
	1	2.72	516	774	2064	15.00	5.00	1.52
	2	2.84	826	1239	3302			2.14
2-1/2"	0	3.23	12	18	--			1.16
	1	3.33	387	581	1548	20.00	8.00	1.86
	2	3.43	619	929	2477			2.56
3"	0	3.78	10	15	--			1.21
	1	3.88	316	474	1264	22.00	9.00	2.00
	2	3.98	506	758	2022			2.80
4"	0	4.85	8	12	--			1.69
	1	4.98	232	348	927	27.00	13.00	2.68
	2	5.10	371	557	1485			3.86
5"	0	5.90	6	9	--			2.50
	1	6.03	191	286	764	31.00	18.00	3.75
	2	6.15	306	458	1222			5.0
6"	0	6.87	5	8	--			3.47
	1	7.10	165	247	660	36.00	19.00	4.75
	2	7.33	264	396	1056			6.04
8"	0	9.09	6	9	--			5.56
	1	9.19	234	350	934	40.00	20.00	9.44
	2	9.28	374	561	1495			13.36
10"	0	11.18	5	8	--			6.80
	1	11.32	230	344	918	50.00	25.00	12.90
	2	11.45	367	551	1469			19.00
12"	0	13.23	3	5	--			9.02
	1	13.37	161	241	643	60.00	30.00	14.83
	2	13.50	257	386	1029			20.64
14"	0	14.70	3	5	--			14.10
	1	14.84	119	178	476	70.00	35.00	21.70
	2	14.98	190	285	760			29.30

COPPER/BRONZE BRAIDED PCB Connectors for Copper Piping

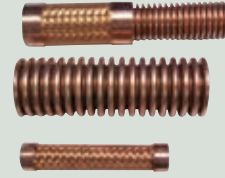

PCB connectors are the standard of the industry in braided connectors for copper piping. This style connector is constructed with bronze corrugated hose and heavy-duty bronze braid for high-pressure ratings. The traditional overall lengths of PCB connectors are designed to isolate equipment vibration and minimum permanent offset. Longer length bronze braided connectors that will accommodate greater lateral pipe motions can be fabricated upon request.

Style PCB-BRSW is offered with standard copper sweat/tube ends. Style PCB-BRMP is built with copper hex male NPT ends. These connectors are typically in stock in sizes ranging from 1/2" to 3" diameter.

Unbraided, Single Braided and Double Braided Bronze Hose

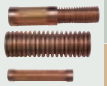

Unbraided, Single Braided and Double Braided Bronze Hose

Nominal Hose I.D. (in.)	Braid Type	Nominal Hose O.D. (in.)	Centerline Bend Radius (in.)		Maximum Pressure @ 70° F (PSIG) ^a		
			Static	Dynamic	Working	Test	Nominal Burst
1/4"	0	.49	1.00	5.50	100	150	--
	1	.57			1035	1553	4142
	2	.65			1656	2646	6627
3/8"	0	.67	1.25	6.00	40	75	--
	1	.75			685	1027	2738
	2	.83			1096	1644	4381
1/2"	0	.82	1.50	7.00	40	60	--
	1	.90			706	1059	2825
	2	.98			1130	1695	4520
3/4"	0	1.21	2.25	8.00	30	36	--
	1	1.31			577	865	2307
	2	1.41			923	1384	3691
1"	0	1.51	3.00	10.00	20	30	--
	1	1.61			470	705	1881
	2	1.71			752	1128	3009
1-1/4"	0	1.85	3.50	12.00	15	23	--
	1	1.95			361	541	1443
	2	2.05			577	865	2309
1-1/2"	0	2.18	4.00	13.50	10	15	--
	1	2.31			329	493	1317
	2	2.43			526	789	2107
2"	0	2.50	5.00	17.00	8	12	--
	1	2.63			317	475	1267
	2	2.75			507	760	2027
2-1/2"	0	3.18	8.00	22.00	8	12	--
	1	3.31			272	408	1090
	2	3.43			435	653	1744
3"	0	3.65	12.00	24.00	10	15	--
	1	3.78			201	301	805
	2	3.91			322	482	1288

Correction Factors For Elevated Temperatures

Apply to pressure rating for elevated temperature

TEMP F	BRONZE
70	1.00
150	.92
200	.89
250	.86
300	.83
350	.81
400	.78
450	.75



Ultraflex: Stainless Steel Hose and Hose & Braid

It is called Ultraflex because it is the ultimate in strength, flexibility and performance. Extremely flexible ISO 10380 conformance, 50,000 cycle rated and pressure rated as per ISO 10380. Available in long lengths on reels or as custom-made assemblies.

Material:

Hose: 321 or 316 stainless steel

Braid: 300 series stainless steel

Construction:

Annular butt welded, hydro formed close pitch corrugated hose.

Ultraflex – Unbraided and Single Braided Hose

Inside Diameter (in.)	Number of Braids (#)	Outside Diameter (in.)	Static Minimum Bend Radius (in.)	Dynamic Minimum Bend Radius (in.)	Maximum Working Pressure (psi)	Burst Pressure (psi)	Weight per Foot (lbs.)
1/4"	0	0.42	.09	3.7	90	n/a	0.07
	1	0.48	.09	3.7	1800	7233	0.14
	2	0.54	.09	3.7	2700	9100	0.20
3/8"	0	0.65	1.0	4.0	70	n/a	0.15
	1	0.71	1.0	4.0	1558	6230	0.25
	2	0.77	1.0	4.0	2336	9345	0.36
1/2"	0	0.77	1.2	4.4	70	n/a	0.18
	1	0.83	1.2	4.4	1186	4743	0.32
	2	0.89	1.2	4.4	1779	7115	0.47
5/8"	0	0.96	1.4	5.6	57	n/a	0.19
	1	1.02	1.4	5.6	1205	4820	0.37
	2	1.08	1.4	5.6	1808	7230	0.54
3/4"	0	1.16	1.7	6.4	43	n/a	0.31
	1	1.22	1.7	6.4	898	3591	0.53
	2	1.28	1.7	6.4	1347	5387	0.74
1"	0	1.47	2.1	7.1	43	n/a	0.41
	1	1.53	2.1	7.1	718	2872	0.76
	2	1.63	2.1	7.1	1077	4308	1.11
1-1/4"	0	1.75	2.5	7.9	43	n/a	0.63
	1	1.83	2.5	7.9	645	2581	1.00
	2	1.91	2.5	7.9	968	3872	1.37
1-1/2"	0	2.08	3.1	8.7	28	n/a	0.70
	1	2.16	3.1	8.7	531	2125	1.16
	2	2.24	3.1	8.7	797	3188	1.63
2"	0	2.61	4.0	10.3	14	n/a	0.88
	1	2.69	4.0	10.3	449	1797	1.44
	2	2.77	4.0	10.3	674	2696	1.99
2-1/2"	0	3.40	5.4	12.8	14	n/a	1.36
	1	3.50	5.4	12.8	417	1669	2.16
	2	3.60	5.4	12.8	626	2504	2.96
3"	0	3.88	6.3	14.5	14	n/a	1.63
	1	3.98	6.3	14.5	346	1384	2.50
	2	4.08	6.3	14.5	519	2076	3.37
4"	0	4.96	7.7	17.4	14	n/a	2.53
	1	5.06	7.7	17.4	299	1194	3.69
	2	5.16	7.7	17.4	448	1791	4.85
5"	0	6.00	10.0	21.9	14	n/a	4.07
	1	6.12	10.0	21.9	275	1099	5.53
	2	6.24	10.0	21.9	412	1649	6.99
6"	0	7.01	11.6	25.0	11	n/a	4.46
	1	7.13	11.6	25.0	210	839	6.34
	2	7.25	11.6	25.0	315	1259	8.22



Ultra High Pressure

402X Construction:

T316L stainless steel hose
 T321 direct double braid
 Annular construction
 For ultra high pressure and hydraulic applications

Sizes: 1/4" through 2"

Maximum Working Pressure:

Full vacuum to 5300 psig depending on size

Temperature: Cryogenic to 1500° F

RF67-XFC

Construction:

T321 hose and braid
 Helical construction
 For ultra high pressure applications

Sizes: 1/4" through 2"

Maximum Working Pressure:

Full vacuum to 12000 psig depending on size

Temperature: Cryogenic to 1500° F

Ultra High Pressure Hose – 402X

NOMINAL HOSE I.D. (IN)	HOSE O.D. (IN)	WEIGHT PER FT. (LBS)	MIN LIVE LENGTH FOR VIBRATION (IN)	MIN. BEND RADIUS (IN)		MAX. WORKING PRESSURE (PSIG) @ 70° F	MAX. TEST PRESSURE (PSIG) @ 70° F	NOMINAL BURST PRESSURE (PSIG) @ 70° F
				STATIC BEND	INTER-MITTENT FLEXING			
1/4"	.63	.39	4.25	2.000	8.250	5300	7950	21200
3/8"	.81	.53	5.00	2.500	9.000	3900	5850	15600
1/2"	1.05	.75	6.00	3.000	10.500	3600	5400	14400
3/4"	1.43	1.63	7.00	4.000	12.750	3550	5325	14200
1"	1.75	2.07	8.25	5.250	15.000	2800	4200	11200
1-1/4"	2.08	2.93	9.00	6.500	17.250	2480	3720	9920
1-1/2"	2.41	3.62	10.00	8.000	19.500	2200	3300	8800
2"	3.05	4.63	12.00	11.500	24.000	1675	2512	6700

Ultra High Pressure Hose – RF67-XFC

NOMINAL HOSE I.D. (IN)	HOSE O.D. (IN)	WEIGHT PER FT. (LBS)	MIN LIVE LENGTH FOR VIBRATION (IN)	MIN. BEND RADIUS (IN)		MAX. WORKING PRESSURE (PSIG) @ 70 F	MAX. TEST PRESSURE (PSIG) @ 70 F	NOMINAL BURST PRESSURE (PSIG) @ 70 F
				STATIC BEND	INTER-MITTENT FLEXING			
1/4"	.68	.62	6.00	2.500	11.500	12000	18000	48000
3/8"	.90	.97	7.00	3.750	15.000	9000	13500	36000
1/2"	1.04	1.34	8.00	4.500	16.500	8500	12750	34000
3/4"	1.52	2.56	9.00	6.500	30.500	6800	10200	27200
1"	1.93	3.69	10.00	9.000	35.000	6250	9375	25000
1-1/4"	2.15	5.08	12.00	10.000	38.000	5500	8250	22000
1-1/2"	2.54	6.63	14.00	12.000	41.000	5200	7800	20800
2"	3.04	8.07	18.00	15.000	48.000	4350	6525	17400

* See page 10 for elevated temperature correction factor chart.

STAINLESS STEEL BRAIDED CONNECTORS

Special Application Assemblies

Engineered Flexible Products, Inc. has the proven capability of fabricating intricate and highly sophisticated assemblies to satisfy the needs of our distributor network. A sampling of these quality assured assemblies are as follows:

JACKETED ASSEMBLY

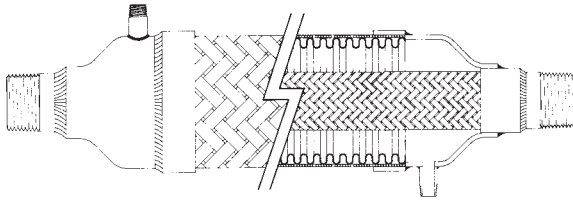

TRACED ASSEMBLY

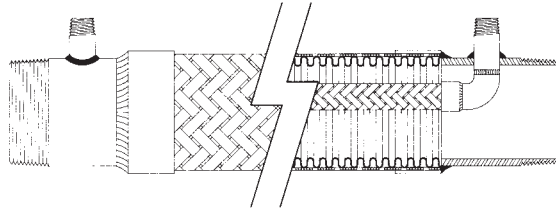

LINED ASSEMBLY

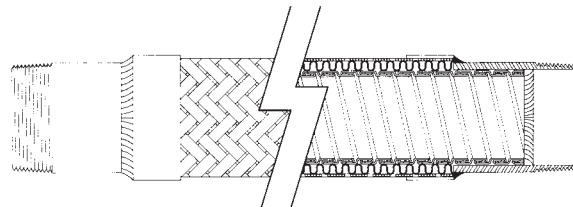

GUARDED ASSEMBLY

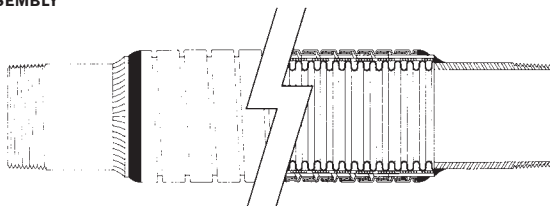

Jacketed Assembly

Jacketed assemblies are normally used in one of the following applications:

1. As a heated transfer line for those products, such as sulphur, which must be maintained at an elevated temperature in order to flow readily. Steam or hot oil is circulated through the jacket, which in turn heats the product being conveyed in the core hose.
2. As a cryogenic transfer line. Maintaining a high vacuum in the jacket effectively insulates cryogenic liquids being conveyed in the core hose.

Traced Assembly

Traced hose assemblies are used when the product being conveyed must be heated in order to flow freely. Steam or hot oil circulated through the inner tracer hose heats the product to maintain high flow rates.

Lined Assembly

Lined hose assemblies are used when the velocity of the conveyed product exceeds the speed at which damaging resonant vibration can initiate in an unlined corrugated metal hose.

Guarded Assembly

Guarded assemblies are used where a corrugated metal hose could easily be damaged by rough handling, abrasion, or flexing past its minimum bend radius.

*Drawings compliments of Hosemaster, Inc.

SEISMIC FLEX LOOPS

Loops for Seismic & Thermal Pipe Motion

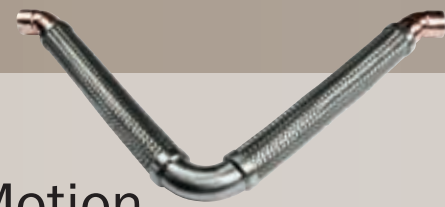

Specified by consulting engineers and building owners and installed by contractors throughout the world for many years, Seismic “V” Loops solve the problems of pipe motion caused by thermal pipe growth and the unpredictable movements associated with seismic activity. Loops can perform the functions of large pipe loops or expansion joints and, in addition, can provide protection and flexibility in multiple planes during potentially catastrophic earthquakes.

Unlike large pipe loops, Seismic “V” Loops take up a minimum of space, providing pipe motion accommodation solutions in limited space situations such as indoor piping. The small configuration the “V” Loops are also far less susceptible to the heat loss that must be dealt with in the case of large pipe loops.

Whereas metal bellows or rubber expansion joints will impose substantial anchor loads due to the effects of static pressure thrust, Seismic “V” Loops will not introduce any thrust loads on the piping system. The unique construction of the braided V-shaped loop creates a flexible product that does not expand when pressurized. A welded-on braid acts as a restraining device, even at extended pressures, yet allows tremendous flexibility. Anchor loads in regard to the “V” Loops are confined to the relatively small spring forces required to deflect the flexible legs within the loop. Unlike expansion joints, a minimum of pipe guiding is required.

Seismic “V” Loops are extremely easy to design in nested configurations. Due to the inherent V-design, standard “V” Loops can simply be nested within each other with relatively tight centering. A substantial amount of space can be saved, and since no additional pipe extensions need to be installed in the “V” Loops, standard models can be used, saving cost and reducing delivery time.

The standard position for the “V” Loop is in a horizontal pipe run, with the elbow pointing straight down. Positioning is versatile, however, and the loops can be installed in many other positions such as laying the loop horizontal, positioning the elbow straight up, or positioning for vertical pipe run. In installations other than the standard position, **EFP** can provide a support eyelet to allow a cable or rod to support the weight of the loop and its contents.



A complete assortment
of Loop products...

- Flanged
- Male NPT
- Copper Sweat
- Grooved
- Beveled Weld Ends

Select the problem-solving “V” Loops for your next project!

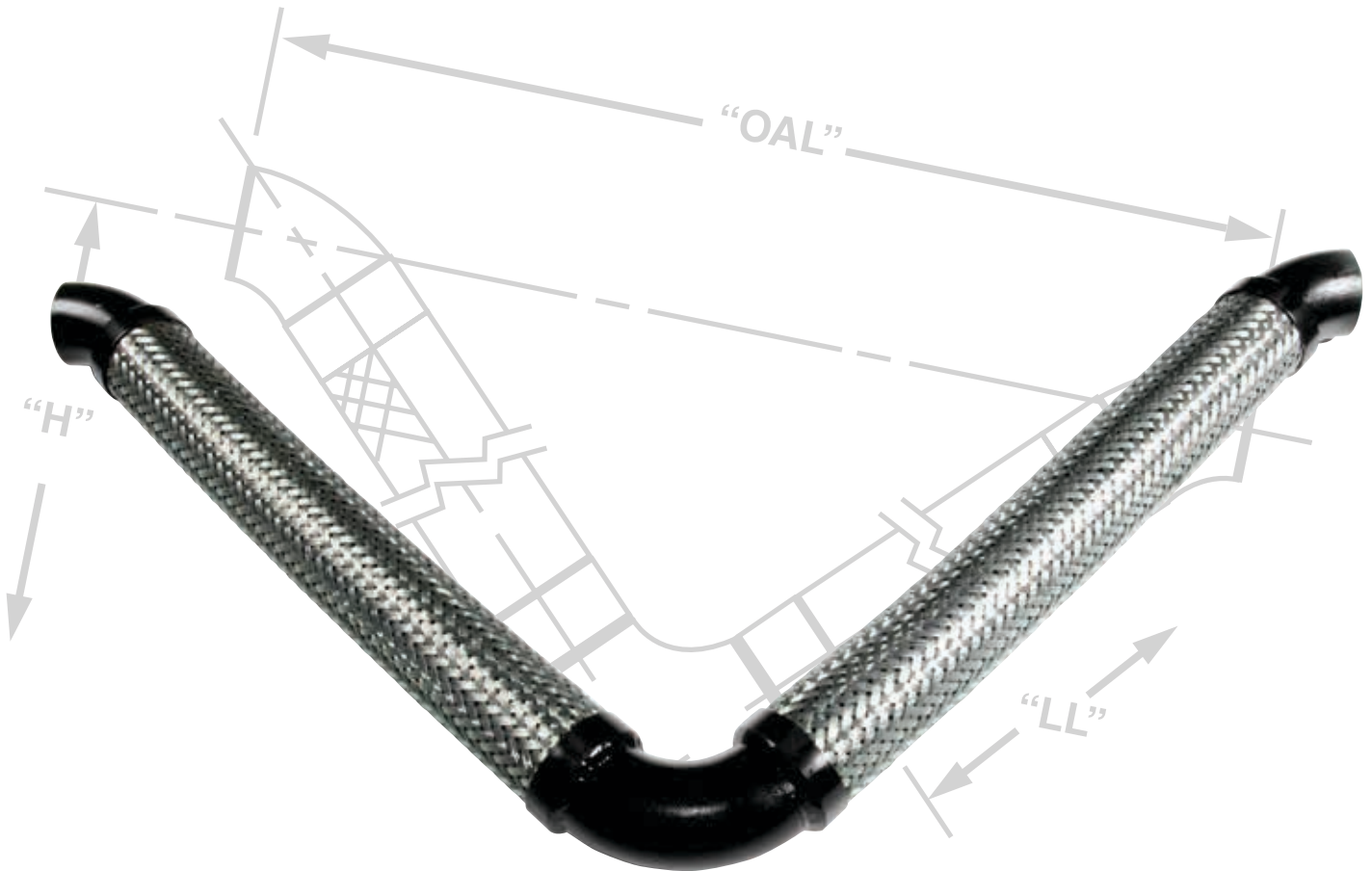

Seismic “V” Loops can be used for a variety of fluids and gases. Loops can be constructed using stainless steel hose and braid with carbon steel end fittings and elbows (other alloys available), or with bronze hose and braid with copper end fittings and elbows. End fitting options include flanges, male threads, beveled weld ends, grooved ends, and copper sweat. Use “V” Loops for applications such as heating and cooling water in HVAC systems; moderate velocity steam; natural gas; gases; fire sprinkler piping; and selected process applications. Drain ports can be added where required. For higher pressure applications, “V” Loops can be constructed using double braided hose legs. Consult **EFP** for specific pressure ratings.

Standard “V” Loops are offered for either 2”, 3” or 4” of motion from center-line in axial and offset planes. Other configuration loops and loops for greater motion can be constructed upon request.



Loops available upon request



Flanged end loops have carbon steel Class 150 plate flanges as standard ends. Raised face flanges, or virtually any other flange configuration can also be ordered. Scheduled 40 carbon steel elbows are also standard, but can be specified in other materials.

As in other configurations of Seismic Loops, choose from either 2”, 3” or 4” of motion from center-line. For steam service, **EFP** recommends placing the loops in either an inverted or horizontal installation when conveying steam. A drain port should also be specified for steam service. We can also add an eyelet at the 90 degree elbow to accommodate a support rod or cable.



Flanged “Loop”

Hose: Type 321 S/S; **Braid:** Type 304 S/S

Elbows: Carbon Steel, Sch 40

Flanges: Plate Flanges (standard), 150# ASA Drilled, Carbon Steel

Seismic “V” Loops – Flanged Loops

SIZE (IN)	OVERALL LENGTH OAL (IN)	LIVE LENGTH LL (IN)	HEIGHT (IN)	APPROX. SPRING FORCE* (LBS)	PRESSURE RATINGS (PSIG) at 70° F		ALLOWABLE MOTIONS X, Y OR Z
					W.P.	MAX. TEST	
1-1/2	28	12-1/2	12-3/4	75	472	708	2"
2	32	14	14-1/2	82	516	774	
2-1/2	35	14-1/2	15-1/2	86	387	581	
3	39-3/4	16-1/2	17-3/4	93	316	474	
4	45-3/4	18	20-1/4	127	232	348	
5	53	20	23	214	191	286	
6	59-1/4	21-1/2	25-3/4	228	165	247	
8	71-1/4	24	30-1/2	312	234	350	
10	84	27	35-1/2	345	230	344	
12	94-3/4	28-1/2	39-1/2	399	161	241	

1-1/2	32-1/4	15-1/2	14-3/4	75	472	708	3"
2	36-1/4	17	16-1/2	82	516	774	
2-1/2	40	18	18	86	387	581	
3	45	20	21-1/2	93	316	474	
4	51-1/2	22	23	127	232	348	
5	59-1/2	24-1/2	26-1/4	214	191	286	
6	66-1/4	26-1/2	29-1/4	228	165	247	
8	79	29-1/2	34-1/4	312	234	350	
10	93-1/4	33-1/2	40	345	230	344	
12	104-3/4	35-1/2	44-1/2	399	161	241	

1-1/2	35-3/4	18	16-1/2	75	472	708	4"
2	40-1/2	20	18-3/4	82	516	774	
2-1/2	43-1/2	20-1/2	19-3/4	86	387	581	
3	49-3/4	23-1/2	22-3/4	93	316	474	
4	56-1/2	25-1/2	25-1/2	127	232	348	
5	65	28-1/2	29	214	191	286	
6	72	30-1/2	32	228	165	247	
8	85-1/2	34	37-1/2	312	234	350	
10	100-1/4	38-1/2	43-3/4	345	230	344	
12	112-1/4	41	48-1/2	399	161	241	

*Total force necessary to accommodate full motion, calculated @ 150 PSIG, Note: 1) Maximum operating temperature: 800° F. 2) Other style flanges available.

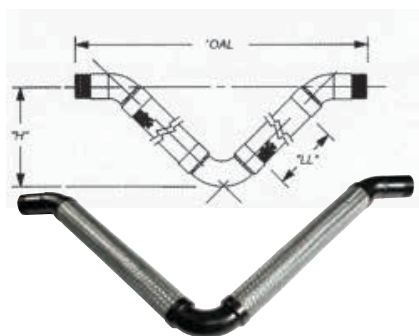

Threaded Loops have carbon steel male NPT threaded ends as standard.

As in other configurations of Seismic Loops, choose from either 2", 3" or 4" of motion from center-line. For steam service, **EFP** recommends placing the loops in either an inverted or horizontal installation when conveying steam. A drain port should also be specified for steam service. We can also add an eyelet at the 90 degree elbow to accommodate a support rod or cable.

Threaded "Loop"

Hose: Type 321 S/S; **Braid:** Type 304 S/S

Elbows: Carbon Steel, Sch 40

Ends: Carbon Steel Sch 40, Male NPT

Seismic "V" Loops – Threaded Loops

SIZE (IN)	OVERALL LENGTH OAL (IN)	LIVE LENGTH LL (IN)	HEIGHT (IN)	APPROX. SPRING FORCE* (LBS)	PRESSURE RATINGS (PSIG) at 70° F		ALLOWABLE MOTIONS X, Y OR Z
					W.P.	MAX. TEST	
1/2	22-1/4	9	9-1/4	35	1075	1613	2"
3/4	23-3/4	10	9-3/4	41	792	1188	
1	27-1/2	11	10-3/4	45	571	857	
1-1/4	29-3/4	12	12	64	531	797	
1-1/2	31-1/2	12-1/2	12-1/2	68	472	708	
2	35-1/2	14	14-1/2	82	516	774	
2-1/2	39-1/2	14-1/2	15-1/2	86	387	581	
3	45-1/2	16-1/2	17-3/4	93	316	474	
4	51-1/2	18	20	127	232	348	

1/2	25-3/4	11-1/2	11	35	1075	1613	3"
3/4	27-1/4	12-1/2	11-1/2	41	792	1188	
1	31	13-1/2	12-3/4	45	571	857	
1-1/4	33-1/2	14-1/2	13-3/4	64	531	797	
1-1/2	35-3/4	15-1/2	14-3/4	68	472	708	
2	39-3/4	17	16-1/2	82	516	774	
2-1/2	44-1/2	18	18	86	387	581	
3	50-1/4	20	20-1/4	93	316	474	
4	59	22	23	127	232	348	

1/2	28-1/2	13-1/2	12-1/4	35	1075	1613	4"
3/4	30-3/4	15	13-1/4	41	792	1188	
1	34-1/2	16	14-1/2	45	571	857	
1-1/4	37	17	15-1/2	64	531	797	
1-1/2	39-1/4	18	16-1/2	68	472	708	
2	44	20	18-1/2	82	516	774	
2-1/2	48	20-1/2	22-3/4	86	387	581	
3	55-1/4	23-1/2	23-1/2	93	316	474	
4	64	25-1/2	25-1/2	127	232	348	

*Total force necessary to accomodate full motion, calculated @ 150 PSIG, Note: 1) Maximum operating temperature: 800° F.



Beveled Weld End Loops are configured with carbon steel schedule 40 beveled weld ends as standard.

As in other configurations of Seismic "V" Loops, choose from either 2", 3" or 4" of motion from center-line. **EFP** recommends placing the loops in either an inverted or horizontal installation when conveying steam. A drain port should also be specified for steam service. We can also add an eyelet at the 90 degree elbow to accommodate a support rod or cable.

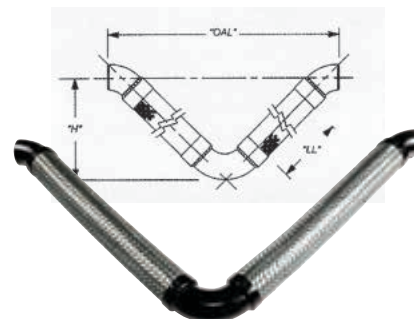

Weld End "Loop"

Hose: Type 321 S/S; **Braid:** Type 304 S/S

Elbows: Carbon Steel, Sch 40

Ends: Carbon Steel Sch 40 Weld End

Seismic "V" Loops– Beveled Weld End Loops

SIZE (IN)	OVERALL LENGTH OAL (IN)	LIVE LENGTH LL (IN)	HEIGHT (IN)	APPROX. SPRING FORCE* (LBS)	PRESSURE RATINGS (PSIG) at 70° F		ALLOWABLE MOTIONS X, Y OR Z
					W.P.	MAX. TEST	
2	31-1/2	14	14-1/2	82	516	774	2"
2-1/2	34-3/4	14-1/2	16	86	387	581	
3	39-1/2	16-1/2	18	93	316	474	
4	45-1/2	18	20-1/2	127	232	348	
5	52-1/2	20	23-1/2	214	191	286	
6	58-3/4	21-1/2	26	228	165	247	
8	71	24	30-1/2	312	234	350	
10	83-1/2	27	36	345	230	344	
12	94	28-1/2	40	399	161	241	

2	36	17	17	82	516	774	3"
2-1/2	39-1/2	18	18-1/2	86	387	581	
3	44-1/2	20	20-1/2	93	316	474	
4	51	22	23-1/2	127	232	348	
5	58-3/4	24-1/2	26-1/2	214	191	286	
6	66	26-1/2	29-1/2	228	165	247	
8	78-3/4	29-1/2	34-1/2	312	234	350	
10	92-3/4	33-1/2	40-1/2	345	230	344	
12	104	35-1/2	45	399	161	241	

2	40	20	19	82	516	774	4"
2-1/2	43	20-1/2	20	86	387	581	
3	49-1/4	23-1/2	23	93	316	474	
4	56	25-1/2	26	127	232	348	
5	64-1/2	28-1/2	29-1/2	214	191	286	
6	71-1/2	30-1/2	32-1/2	228	165	247	
8	85	34	38	312	234	350	
10	100	38-1/2	44	345	230	344	
12	112	41	49	399	161	241	

* Total force necessary to accommodate full motion, calculated @ 150 PSIG, Note: 1) Maximum operating temperature: 800° F.

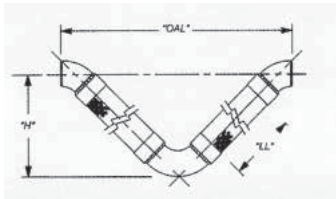

Grooved End Loops are constructed with carbon steel schedule 40 grooved ends for easy installation.

As in other configurations of Seismic "V" Loops, choose from either 2", 3" or 4" of motion from center-line. We can also add an eyelet at the 90 degree elbow to accommodate a support rod or cable.

Grooved End "Loop"

- Hose:** Type 321 S/S; **Braid:** Type 304 S/S
- Elbows:** Carbon Steel, Sch 40 Grooved Ends
- Ends:** Carbon Steel Grooved

Seismic "V" Loops– Grooved End

SIZE (IN)	OVERALL LENGTH OAL (IN)	LIVE LENGTH LL (IN)	HEIGHT (IN)	APPROX. SPRING FORCE* (LBS)	PRESSURE RATINGS (PSIG) at 70° F		ALLOWABLE MOTIONS X, Y OR Z
					W.P.	MAX. TEST	
2	38	14	14-1/2	82	516	774	2"
2-1/2	41-1/8	14-1/2	16	86	387	581	
3	45-7/8	16-1/2	18	93	316	474	
4	51-7/8	18	20	127	232	348	
5	58-7/8	20	23-1/2	214	191	286	
6	64-3/4	21-1/2	26	228	165	247	
8	77-3/8	24	30-1/2	312	234	350	
10	90	27	36	345	230	344	
12	100-3/4	28-1/2	40	399	161	241	

2	42-3/8	17	17	82	516	774	3"
2-1/2	46	18	18-1/2	86	387	581	
3	50-3/4	20	20-1/2	93	316	474	
4	57-1/2	22	23-1/2	127	232	348	
5	65-1/4	24-1/2	26-1/2	214	191	286	
6	72-3/8	26-1/2	29-1/2	228	165	247	
8	85-1/8	29-1/2	34-1/2	312	234	350	
10	99-1/4	33-1/2	40-1/2	345	230	344	
12	110-5/8	35-1/2	45	399	161	241	

2	46-1/2	20	19	82	516	774	4"
2-1/2	49-5/8	20-1/2	20	86	387	581	
3	55-3/4	23-1/2	23	93	316	474	
4	62-3/8	25-1/2	26	127	232	348	
5	70-7/8	28-1/2	29-1/2	214	191	286	
6	78	30-1/2	32-1/2	228	165	247	
8	91-1/2	34	38	312	234	350	
10	106-3/8	38-1/2	44	345	230	344	
12	118-3/8	41	49	399	161	241	

* Total force necessary to accommodate full motion, calculated @ 150 PSIG.

Note: 1) Maximum operating temperature: 800° F.

Copper Sweat Loops are designed specifically for copper piping systems. They are constructed with copper female sweat ends and copper elbows and either stainless steel braided hose or bronze hose, depending on size. Those loops using stainless steel braided hose will also utilize stainless steel 90-degree return elbows.

As in other configurations of Seismic "V" Loops, choose from either 2", 3" or 4" of motion from center-line. We can also add an eyelet at the 90 degree elbow to accommodate a support rod or cable.

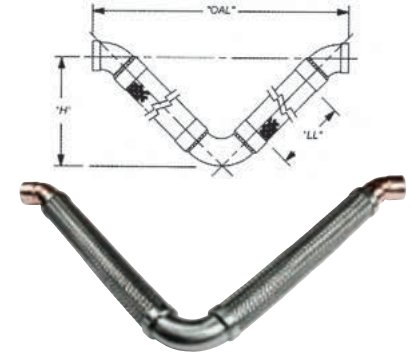

Bronze/Copper "Loop"

Hose: Bronze Hose & Braid: 1/2" - 2", Stainless Hose & Braid: 2-1/2" - 4"

Elbows: Copper

Ends: Female Copper Sweat

Seismic "V" Loops – Copper Sweat Loops

SIZE (IN)	OVERALL LENGTH OAL (IN)	LIVE LENGTH LL (IN)	HEIGHT (IN)	APPROX. SPRING FORCE* (LBS)	PRESSURE RATINGS (PSIG) at 70° F		ALLOWABLE MOTIONS X, Y OR Z
					W.P.	MAX. TEST	
1/2	20-1/4	9-1/2	9-1/4	34	706	1059	2"
3/4	22-3/4	10	10-1/4	40	577	865	
1	24-1/2	10-1/2	11	44	470	705	
1-1/4	27-1/2	11-1/2	12	65	361	541	
1-1/2	29	12	12-3/4	70	329	493	
2	32-1/2	13	14	80	317	475	
2-1/2	36-3/4	15-1/2	17	86	272	408	
3	41-1/2	17	19	93	201	301	
4	48	18	21	127	142	213	
1/2	23-3/4	12	11-1/2	34	706	1059	3"
3/4	26-1/4	12-1/2	12-1/2	40	577	865	
1	28	13	13	44	470	705	
1-1/4	31	14	14	65	361	541	
1-1/2	32-1/2	14-1/2	15	70	329	493	
2	36-3/4	16	16-1/2	80	317	475	
2-1/2	41-3/4	18	19	86	272	408	
3	46-1/2	20	21	93	201	301	
4	53-1/2	22	24	127	142	213	
1/2	26-1/2	14	12-1/2	34	706	1059	4"
3/4	30	15	14	40	577	865	
1	31-3/4	15	14	44	470	705	
1-1/4	34-1/2	16-1/2	16	65	361	541	
1-1/2	36	17	16-1/2	70	329	493	
2	40-1/4	18-1/2	18-1/2	80	317	475	
2-1/2	45-1/4	20-1/2	20-1/4	86	272	408	
3	51-1/2	23-1/2	23-1/2	93	201	301	
4	58-1/2	25-1/2	26-1/2	127	142	213	

* Total force necessary to accommodate full motion, calculated @ 150 PSIG.
See hose charts on pages 13 and 15 for temperature limits.

SPECIAL HVAC/EXPANSION COMPENSATORS

Compensators – H & HB Series

For the compensation of thermal growth in small diameter piping systems, expansion compensators are the ideal choice. These economical expansion components utilize the design theory behind externally pressurized expansion joints that are used in large diameter steam piping and apply these designs to smaller size, lower temperature piping systems.

Expansion compensators are often used in HVAC systems such as hot water lines and steam condensate to absorb the effects of thermal pipe growth. Like externally pressurized expansions joints, expansion compensators are a packless, maintenance-free joint that incorporates an all-stainless-steel, multi-ply flexible bellows, a steel enclosure, with an external and internal guide ring/sleeve to maintain proper alignment of the inner pipe. The sleeve isolates the bellows from media, eliminating flow turbulence. External pressure is applied to the bellows via a gap between the internal flange and the housing. Bellows squirm is eliminated by means of an internal flange, and also guides the bellows along the longitudinal center-line. The external pressure keeps the bellows stable. For proper operation, expansion compensators must be adequately anchored and guided.

Choose from either Style H-MMT with carbon steel male NPT threaded ends or Style HB-FFS with copper tube ends. Carbon steel beveled weld ends or flanged ends can be attached upon request. Most styles are available in sizes from 3/4" through 4". All sizes and styles are rated for 2 1/2" of axial travel. (2" compression 1/2" extension.)



Compensators – H & HB Series

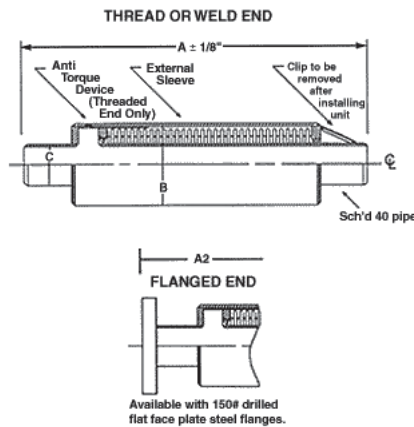

H Series
200 PSI up to 750° F

PIPE SIZE		THREAD/WELD END	FLANGED	B	C
INCH	MM	A1	A2		
3/4"	20	12-3/4"	13-3/8"	2-3/8"	1.05
1"	25	13-1/4"	13-7/8"	2-1/2"	1.31
1-1/4"	32	13-1/4"	13-7.8"	3"	1.66
1-1/2"	38	14-5/8"	15-1/4"	3-1/2"	1.90
2"	50	14-5/8"	15-1/4"	4"	2.37
2-1/2"	65	16"	16-5/8"	5"	2.87
3"	80	16"	16-5/8"	5-1/2"	2.87
4"	100	16-3/8"	17"	6-5/8"	4.50

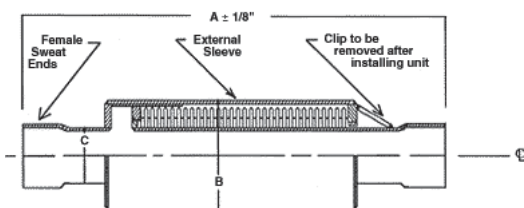

HB Series
200 PSI up to 400° F

PIPE SIZE		A OAL	B O.D.	SWEAT I.D.
INCH	MM			
3/4"	20	11"	1-5/8"	.879"
1"	25	11-1/4"	2"	1.130
1-1/4"	32	12-1/2"	2-1/4"	1.380
1-1/2"	38	12-7/8"	2-1/2"	1.630
2"	50	13"	3"	2.130
2-1/2"	65	13-1/4"	4"	2.630
3"	80	14"	4-1/2"	3.130



SPECIAL CONNECTORS

Series BPC & BPC-R Bellows Pump Connectors

Series BPC and Series BPC-R Bellows Pump Connectors are an ideal solution when a flexible pipe connector is required in severe service applications.

Often, an application will require a connector to isolate noise and vibration, relieve stresses on equipment, and handle both high temperatures and axial motion. Rubber connectors will have relatively low pressure ratings at high temperatures. Braided connectors can offer high pressure/high temperature capabilities, but do not offer any axial movement capabilities. Pressure ratings of bellows pump connectors are virtually unaffected by high system temperatures and these special connectors are able to absorb limited amounts of axial travel and lateral offset. The special design of Series BPC and Series BPC-R connectors includes multi-ply stainless

steel bellows to provide long life and isolation in high-frequency applications. Three built-on tie rods prevent over-extension in high pressures and eliminate jobsite installation of rod assemblies. Special rubber grommets are installed on each end of rods so that noise and vibration is not transmitted across the steel rods.

Series BPC bellows pump connectors are our standard overall length connector designed to provide 1/2" compression and 1/8" lateral motion, plus pump vibration. Series BPC-R connectors are constructed in overall lengths to match standard single rubber connectors. BPC-R connectors will provide about 1" compression, 3/8" extension and from 1/8" to 5/16" lateral motion, plus pump vibration. Sizes larger than 12" available upon request.



Series BPC & BPC-R Bellows Pump Connectors



Series BPC Bellows Pump Connectors

PART #	SIZE (IN)	OAL (IN)	LIVE LENGTH (IN)	EFFECTIVE AREA (IN. ²)	APPROX. WGT (LBS)	RATED COMP (IN)	RATED EXT. (IN)	RATED OFFSET (IN)	WORKING PRESSURE (PSIG)	
									AT 70° F	AT 360° F
BPC-200-FLG	2	4-3/8	3-1/8	6.9	10.5	0.50	0.125	0.125	225	210
BPC-250-FLG	2-1/2	4-3/8	3-1/8	6.9	14.5	0.50	0.125	0.125	225	210
BPC-300-FLG	3	4-3/8	3-1/8	8.8	16.5	0.50	0.125	0.125	225	210
BPC-400-FLG	4	4-5/8	3-1/8	15.1	26.0	0.50	0.125	0.125	225	210
BPC-500-FLG	5	4-7/8	3-3/8	23.5	32.0	0.50	0.125	0.125	225	210
BPC-600-FLG	6	5	3-1/2	33.2	37.0	0.50	0.125	0.125	225	210
BPC-800-FLG	8	5-7/8	3-7/8	59.3	65.0	0.50	0.125	0.125	225	210
BPC-1000-FLG	10	6-1/4	4-1/4	93.5	86.0	0.50	0.125	0.125	225	210
BPC-1200-FLG	12	6-5/8	4-5/8	134.0	112.0	0.50	0.125	0.125	225	210

Series BPC-R Bellows Pump Connectors

PART #	SIZE (IN)	OAL (IN)	LIVE LENGTH (IN)	EFFECTIVE AREA (IN. ²)	APPROX. WGT (LBS)	RATED COMP (IN)	RATED EXT. (IN)	RATED OFFSET (IN)	WORKING PRESSURE (PSIG)	
									AT 70° F	AT 360° F
BPC-R-200-FLG	2	6	4-3/4	6.9	12	0.9	0.2	0.66	225	210
BPC-R-250-FLG	2-1/2	6	4-3/4	6.9	16	0.9	0.2	0.53	225	210
BPC-R-300-FLG	3	6	4-3/4	8.8	18	0.9	0.2	0.45	225	210
BPC-R-400-FLG	4	6	4-1/2	15.1	28	1.0	0.2	0.39	225	210
BPC-R-500-FLG	5	6	4-1/2	33.2	34	1.0	0.2	0.31	225	210
BPC-R-600-FLG	6	6	4-1/2	33.2	43	1.0	0.2	0.26	225	210
BPC-R-800-FLG	8	6	4	59.3	63	1.0	0.2	0.22	225	210
BPC-R-1000-FLG	10	8	6	93.5	93	1.4	0.2	0.33	225	210
BPC-R-1200-FLG	12	8	6	134.0	120	1.4	0.2	0.26	225	210

EXPANSION JOINTS

Externally Pressurized Expansion Joints – 150# & 300# Styles

Externally Pressurized Expansion Joints are used in straight runs of pipe to accommodate large amounts of thermal expansion. Typical applications would include steam systems, where extreme temperature differentials would cause thermal growth of the piping system. Externally pressurized expansion joints are a packless, maintenance-free joint that incorporates an all-stainless-steel flexible bellows, a steel enclosure, with external and internal guide ring/sleeve to maintain alignment of the inner pipe. The sleeve isolates the bellows from media, eliminating flow turbulence. External pressure is applied to the bellows via a gap between the internal flange and housing. Movement limitation is accomplished by means of an internal flanged, and also guides the bellows along the longitudinal centerline. The external pressure keeps the bellows stable.

Externally pressurized expansion joints have significant advantages over pipe loops because they are able to absorb very large axial movements and take up far less space than pipe loops. Typically these applications are indoors, in utility tunnels, or buried where extra space is not available. Externally pressurized expansion joints are also frequently specified instead of slip joints that are also engineered for large movements because of several factors. Slip joints are a packed product that require periodic inspection and maintenance. Access vaults are always required for packed joints. Externally pressurized joints are of a packless, all-welded construction that does not require inspection and can be installed in remote locations or even directly buried. **EFP's** externally pressurized expansion joints are a long-life quality piping product that carries a Five-Year Limited Leak-Free/Maintenance-Free Warranty. Contact us for details.

Select either 150 PSIG or 300 PSIG bellows construction. Single bellows styles are available for 4", 6", or 8" of axial travel. Dual styles can accommodate either 8", 12", or 16" of travel. Flanges or weld end are additional options. Meets MIL-E-17813F Type II Class 4. Standard bellows are constructed of single ply or multi-ply Type 304 stainless steel and are suitable for most chloride free applications such as steam, condensate, oil and chilled water. Where chlorides may be present, Inconel 600 bellows should be specified. Special bellows material would include 316SS, 321SS, Inconel 600 and Inconel 625. Other bellows alloys are available upon request. Pipe end connections are plain steel.



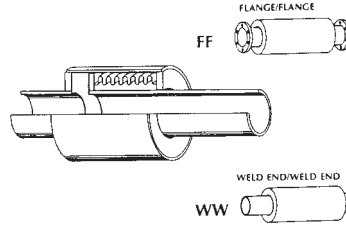

Externally Pressurized Expansion Joint – Construction

FITTINGS – Flanges or beveled weld ends are standard.

INTERNAL & EXTERNAL GUIDES – Insures proper guiding of pipe inside joint.

DRAIN – For draining liquids or location for installing a steam trap.

BELLOWS – Single or multi-ply. 304SS is standard.

INTERNAL LINER – Carbon steel pipe liner prevents turbulence.

COVER – Excellent protection and is designed for full line pressure.

Available Styles and Options:

- Single or dual bellows
- 150# or 300# pressure ratings (with appropriate 150# or 300# drilled flanges)
- Standard T-304 SS bellows or specify 316SS, 321SS, Inco 600, or Inco 625
- Anchor base is standard on dual units and optional on single units
- Ends can be flange x flange, weld x weld, or flange x weld

Externally Pressurized

Externally pressurized expansion joints are designed for use in straight pipe runs to accommodate for high pressure and large thermal expansion and contraction. External pressure is applied to the bellows via a gap between the internal flange and housing. This keeps the bellows from becoming unstable, thus, allowing a longer bellows to be manufactured.

Externally Pressurized

SIZE	O.A.L.										EFFECTIVE AREA IN ²	SHELL O.D. IN.
	SINGLE					DOUBLE						
	AXIAL MOVE	FF	WT.	WW	WT.	AXIAL MOVE	FF	WT.	WW	WT.		
2"	4	24-7/8	34	24-1/4	26	8	43-1/4	70	39-1/2	60	16	6-5/8
	8	38-5/8	58	38	47	16	75-1/4	126	71-1/2	112		
2-1/2"	4	25-1/8	40	24-1/2	29	8	43-1/4	79	39-1/2	65	16	6-5/8
	8	38-5/8	58	38	47	16	75-1/4	126	71-1/2	112		
3"	4	23-7/8	51	23-1/4	38	8	41-1/4	98	37-1/2	82	16	6-5/8
	8	38-3/8	75	37-3/4	62	16	71-1/4	154	67-1/2	138		
4"	4	23-7/8	66	24-1/4	59	8	42-1/2	153	38-3/4	127	35	8-5/8
	8	37-7/8	110	37-1/4	94	16	73-3/4	242	70	216		
5"	4	25	112	24-1/4	91	8	40-1/4	200	36	170	35	10-3/4
	8	38-1/4	165	37-1/2	144	16	64-3/4	286	60-1/2	296		
6"	4	25-1/2	138	24-3/4	115	8	40-1/4	222	36-1/4	184	54	10-3/4
	8	38-1/2	200	37-3/4	177	16	64-3/4	316	60-3/4	278		
8"	4	28-1/4	198	27-1/4	153	8	42-1/2	320	38-1/4	260	88	12-3/4
	8	42	283	41	238	16	69	490	64-3/4	430		
10"	4	27	240	26	186	8	45-1/4	450	40-1/2	364	118	14-1/2
	8	40-1/4	342	39-1/4	238	16	78	706	73-1/4	620		
12"	4	27	308	26	226	8	47-1/4	583	42-1/4	455	163	16-3/4
	8	39-3/4	428	38-3/4	346	16	81-3/4	907	76-3/4	779		
14"	4	28-1/4	491	24-1/2	293	8	47-1/2	709	42-1/4	529	196	18
	8	45-1/2	671	41-3/4	473	16	82	1069	76-3/4	889		
16"	4	28-3/4	547	24-1/2	329	8	48	774	42-1/4	574	354	24
	8	46	749	41-3/4	530	16	82-1/2	1176	76-3/4	976		
18"	4	29	652	24-1/2	364	8	48-1/4	893	42-1/4	663	354	24
	8	46-1/4	875	41-3/4	588	16	82-3/4	1341	76-3/4	1081		
20"	4	29-3/4	766	24-1/2	400	8	49	1054	42-1/4	724	501	28
	8	47	1012	41-3/4	696	16	83-1/2	1544	76-3/4	1214		
24"	4	30-1/4	961	24-1/2	472	8	49-1/2	1292	42-1/4	852	583	30
	8	47-1/2	1250	41-3/4	761	16	84	1870	76-3/4	1430		

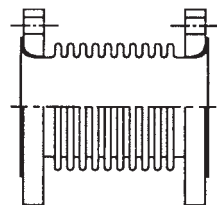

FLANGED END

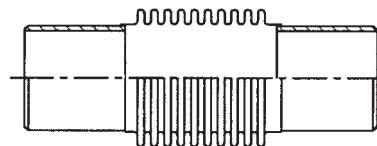

WELD END

Low Corrugation

Expansion joints with low corrugations.

Low Corrugation Expansion Joints provide perfect balance between value and performance. With two standard lengths and three pressure ratings available, they can be delivered quickly. Non-standard designs are also easily available.

Maximum Working Pressure: 50/150/300 psi

Maximum Temperature: 850° F

Test Pressure: 75/225/450 psi

Bellows: T-321 & T-316

End Fittings:

Flanges: ANSI B16.5

Weld Ends: A 53 / A 106

Low Corrugation

SIZE	SHORT/ LONG	COMPRESSION			FLANGED ENDS						WELD ENDS					
		50 PSI (IN)	150 PSI (IN)	300 PSI (IN)	50 PSI		150 PSI		300 PSI		50 PSI		150 PSI		300 PSI	
					OAL (IN)	WT (LBS)	OAL (IN)	WT (LBS)	OAL (IN)	WT (LBS)	OAL (IN)	WT (LBS)	OAL (IN)	WT (LBS)	OAL (IN)	WT (LBS)
2"	S	1-1/8	1-1/8	3/4	6-1/2	11	6-1/2	11	6-1/2	12	9-7/8	3	9-7/8	3	9-7/8	3
	L	1-3/4	1-3/4	1-1/4	8-1/2	13	8-1/2	13	8-1/2	14	11-3/4	4	11-3/4	4	11-3/4	4
3"	S	1	1	3/4	7-3/8	17	7-3/8	20	7-3/8	21	10-1/2	5	10-1/2	5	10-1/2	5
	L	2	2	1-3/8	9	18	9	21	9	22	12	6	12	6	12	7
4"	S	1-1/4	1-1/4	7/8	7-1/2	27	7-1/2	35	7-1/2	37	10-5/8	8	10-5/8	8	10-5/8	9
	L	2-1/2	2-1/2	1-3/4	10-3/4	28	10-3/4	38	10-3/4	40	13-3/4	9	13-3/4	10	13-3/4	10
5"	S	1-1/4	1-1/4	3/4	7-5/8	33	7-5/8	45	7-5/8	47	10-5/8	13	10-5/8	14	10-5/8	14
	L	2-1/2	2-1/2	1-3/4	11-1/4	34	11-1/4	49	11-1/4	51	14-1/4	15	14-1/4	16	14-1/4	17
6"	S	1-1/4	1-1/4	3/4	8	43	8	85	8	89	11	18	11	19	11	20
	L	2-1/2	2-1/2	1-3/4	11-1/2	47	11-1/2	90	11-1/2	94	14-1/2	20	14-1/2	21	14-1/2	22
8"	S	1-1/4	1-1/2	1	9-1/4	64	9-1/4	120	9-1/4	126	12-1/8	22	12-1/8	23	12-1/8	24
	L	2-1/2	3	2	13-1/4	71	13-1/4	125	13-1/4	131	16-1/8	26	16-1/8	27	16-1/8	29
10"	S	1-1/2	1-1/2	1	9-3/8	45	9-3/8	160	9-3/8	168	12-1/8	25	12-1/8	26	12-1/8	27
	L	3-3/8	3-1/4	2-1/2	14-3/8	52	14-3/8	170	14-3/8	179	17-1/4	32	17-1/4	34	17-1/4	35
12"	S	1-1/2	1-1/2	1	9-3/4	70	9-3/4	200	9-3/4	210	12-1/2	35	12-1/2	37	12-1/2	39
	L	3-1/4	3-1/8	2-1/4	13-1/2	85	13-1/2	220	13-1/2	231	16-1/4	42	16-1/4	44	16-1/4	46

* Custom joints readily available.

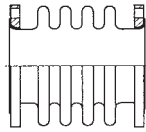

FLANGED END

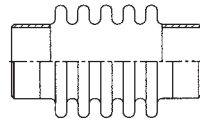

WELD END



High Corrugation

SIZE	NO CORR	50 PSI CLASS, SINGLE *						150 PSI CLASS, SINGLE *					
		MOVEMENT*		FLANGED		WELD ENDS		MOVEMENT*		FLANGED		WELD ENDS	
		COMP (IN)	EXT (IN)	OAL (IN)	WT (LBS)	OAL (IN)	WT (LBS)	COMP (IN)	EXT (IN)	OAL (IN)	WT (LBS)	OAL (IN)	WT (LBS)
2-1/2 & 3"	1	3/8	1/8	6-1/4	19	8-1/8	9	1/4	1/8	6-1/4	19	8-1/8	9
	2	3/4	3/8	7-1/2	20	9-3/8	10	1/2	1/4	7-1/2	20	9-3/8	10
	3	1-1/8	1/2	8-3/4	21	10-5/8	11	3/4	3/8	8-3/4	21	10-5/8	11
	4	1-1/2	3/4	10	22	11-7/8	12	1	1/2	10	22	11-7/8	12
	5	1-7/8	7/8	11-1/4	23	13-1/8	13	1-1/4	5/8	11-1/4	23	13-7/8	13
	6	2-1/4	1-1/8	12-1/2	24	14-3/8	14	1-1/2	3/4	12-1/2	24	14-3/8	14
	7	2-5/8	1-1/4	13-3/4	25	15-5/8	15	-	-	-	-	-	-
	8	3	1-1/2	15	26	16-7/8	16	-	-	-	-	-	-
4"	1	3/8	1/8	6-1/4	28	8-3/8	11	1/4	1/8	6-1/4	28	8-3/8	11
	2	3/4	3/8	7-1/2	29	9-5/8	12	1/2	1/4	7-1/2	29	9-5/8	12
	3	1-1/8	1/2	8-3/4	30	10-7/8	13	3/4	3/8	8-3/4	30	10-7/8	13
	4	1-1/2	3/4	10	31	12-1/8	14	1	1/2	10	31	12-1/8	14
	5	1-7/8	7/8	11-1/4	32	13-3/8	15	1-1/4	5/8	11-1/4	32	13-3/8	15
	6	2-1/4	1-1/8	12-1/2	33	14-5/8	16	1-1/2	3/4	12-1/2	33	14-5/8	16
	7	2-5/8	1-1/4	13-3/4	34	15-7/8	17	-	-	-	-	-	-
	8	3	1-1/2	15	35	17-1/8	18	-	-	-	-	-	-
5"	1	3/8	1/8	6-3/4	33	8-3/8	14	1/4	1/8	6-3/4	33	8-3/8	14
	2	3/4	3/8	8	35	9-5/8	16	1/2	1/4	8	35	9-5/8	16
	3	1-1/8	1/2	9-1/4	37	10-7/8	18	3/4	3/8	9-1/4	37	10-7/8	18
	4	1-1/2	3/4	10-1/2	39	12-1/8	20	1	1/2	10-1/2	39	12-1/8	20
	5	1-7/8	7/8	11-3/4	41	13-3/8	22	1-1/4	5/8	11-3/4	41	13-3/8	22
	6	2-1/4	1-1/8	13	43	14-5/8	24	1-1/2	3/4	13	43	14-5/8	24
	7	2-5/8	1-1/4	14-1/4	45	15-7/8	26	-	-	-	-	-	-
	8	3	1-1/2	15-1/2	47	17-1/8	28	-	-	-	-	-	-
	9	3-3/8	-	16-3/4	49	18-3/8	30	-	-	-	-	-	-
	10	3-3/4	-	18	51	19-5/8	32	-	-	-	-	-	-
6"	1	1/2	1/4	6-1/4	43	7-5/8	20	3/8	1/8	6-1/4	43	7-5/8	20
	2	1	1/2	8	46	9-3/8	23	3/4	3/8	8	46	9-3/8	23
	3	1-1/2	3/4	9-3/4	49	11-1/8	26	1-1/8	1/2	9-3/4	49	11-1/8	26
	4	2	1	11-1/2	52	12-7/8	29	1-1/2	3/4	11-1/2	52	12-7/8	29
	5	2-1/2	1-1/4	13-1/4	55	14-5/8	32	1-7/8	7/8	13-1/4	55	14-5/8	32
	6	3	1-1/2	15	58	16-3/8	35	2-1/4	1-1/8	15	58	16-3/8	35
	7	3-1/2	1-3/4	16-3/4	61	18-1/8	38	-	-	-	-	-	-
	8	4	2	18-1/2	64	19-7/8	41	-	-	-	-	-	-
	9	4-1/2	2-1/4	20-1/2	67	21-5/8	44	-	-	-	-	-	-
	10	5	2-1/2	22-1/4	70	23-3/8	47	-	-	-	-	-	-
8"	1	1/2	1/4	6-1/2	58	9-5/8	28	3/8	1/8	6-1/2	64	9-5/8	28
	2	1	1/2	8-1/4	62	11-3/8	32	3/4	3/8	8-1/4	66	11-3/8	32
	3	1-1/2	3/4	10	66	13-1/8	36	1-1/8	1/2	10	68	13-1/8	36
	4	2	1	11-3/4	70	14-7/8	40	1-1/2	3/4	11-3/4	70	14-7/8	40
	5	2-1/2	1-1/4	13-1/2	74	16-5/8	44	1-7/8	7/8	13-1/2	74	16-5/8	44
	6	3	1-1/2	15-1/4	78	18-3/8	48	2-1/4	1-1/8	15-1/4	78	18-3/8	48
	7	3-1/2	1-3/4	17	82	20-1/8	52	2-5/8	1-1/4	17	82	20-1/8	52
	8	4	2	18-3/4	86	21-7/8	56	3	1-1/2	18-3/4	86	21-7/8	60
	9	4-1/2	2-1/4	20-1/2	90	23-5/8	60	-	-	-	-	-	-
	10	5	2-1/2	22-1/4	94	25-3/8	64	-	-	-	-	-	-
10"	1	1/2	1/4	6-7/8	76	9-3/4	31	3/8	1/8	6-7/8	89	9-3/4	31
	2	1	1/2	8-3/4	80	11-5/8	35	3/4	3/8	8-3/4	91	11-5/8	35
	3	1-1/2	3/4	10-5/8	84	13-1/2	39	1-1/8	1-1/8	10-5/8	93	13-1/2	39
	4	2	1	12-1/2	88	15-3/8	43	1-1/2	1-1/2	12-1/2	95	15-3/8	43
	5	2-1/2	1-1/4	14-3/8	92	17-1/4	47	1-7/8	1-7/8	14-3/8	97	17-1/4	47
	6	3	1-1/2	16-1/4	96	19-1/8	51	2-1/4	2-1/4	16-1/4	99	19-1/8	51
	7	3-1/2	1-3/4	18-1/8	100	21	55	2-5/8	2-5/8	18-1/8	102	21	55
	8	4	2	20	104	22-7/8	59	3	3	20	105	22-7/8	59
	9	4-1/2	2-1/4	21-7/8	108	24-3/4	63	-	-	-	-	-	-
	10	5	2-1/2	23-3/4	112	26-5/8	67	-	-	-	-	-	-
12"	1	1/2	1/4	7-7/8	118	10-3/8	33	3/8	1/8	7-7/8	135	10-3/8	33
	2	1	1/2	9-3/4	123	12-1/4	38	3/4	3/8	9-3/4	137	12-1/4	38
	3	1-1/2	3/4	11-5/8	128	14-1/8	43	1-1/8	1/2	11-5/8	141	14-1/8	43
	4	2	1	13-1/2	133	16	48	1-1/2	3/4	13-1/2	142	16	48
	5	2-1/2	1-1/4	15-3/8	138	17-7/8	53	1-7/8	7/8	15-3/8	144	17-7/8	53
	6	3	1-1/2	17-1/4	143	19-3/4	58	2-1/4	1-1/8	17-1/4	145	19-3/4	58
	7	3-1/2	1-3/4	19-1/8	148	21-5/8	63	2-5/8	1-1/4	19-1/8	147	21-5/8	63
	8	4	2	21	153	23-1/2	68	3	1-1/2	21	150	23-1/2	68
	9	4-1/2	2-1/4	22-7/8	158	25-3/8	73	-	-	-	-	-	-
	10	5	2-1/2	24-3/4	163	27-1/4	78	-	-	-	-	-	-

High Corrugation

Expansion joints with high corrugations.

High Corrugation HC uses a hydroformed bellows for minimal residual stresses and minimal thinning at the convolution root and crown. It is an excellent choice for any application within the pressure ratings of the 150 and 50 psi classes.

Maximum Working Pressure:
50 or 150 psi

Maximum Working Temperature: 850° F

Test Pressure: 75/225 psi

Bellows: T-321 & T-316

End Fittings:

Flanges: ANSI B16.5

Weld Ends: A 53 / A 106

*This table only shows standard designs. For other movement, lengths, or sizes, contact us.

TEFLON® 440 SERIES

2 & 3 Arch Styles



“Tef-Flex connectors are highly flexible, dependable, and versatile.”

Tef-Flex 442 and 443 Convolute PTFE Bellows Expansion Joints and Flexible Couplings offer the best combination of low spring-rate flexibility, temperature resistance, and the chemical inert properties of PTFE material. The “Tef-Flex” 442 2-Convolute Flexible Coupling and 443 3-Convolute Expansion Joint were designed to meet the needs of the HVAC, high-technology, and chemical/petrochemical industries. The “Tef-Flex” bellows connectors are versatile and will 1) absorb pipe movements and stress; 2) isolate mechanical vibration; 3) reduce system noise; 4) protect against surge forces. “Tef-Flex” connectors are suitable for connection to metallic piping or plastic lined metallic piping.

The construction of the “Tef-Flex” connector uses 2, 3, or even 5 molded convolutions of white PTFE. These convolutions are reinforced with metallic rings between the bellows for pressure rating and stability. Standard ductile iron backing flanges are protected by the lip of the PTFE bellows, so that all wetted surfaces are PTFE. Steel limit rods are factory installed. Additional convolutions provide greater movement capability. Styles 442 & 443 include Options include high purity cleaning and packaging.

***Contact us for larger sizes.**



2 & 3 Arch Styles

2 Arch Style

MODEL #	JOINT SIZE I.D. (IN)	FACE-TO-FACE (IN)	MAXIMUM AXIAL TRAVERSE (IN)	MAXIMUM OFFSET (IN)	PRESSURE (PSI) VS. TEMPERATURE				GROSS WT. (LBS)
					70° F	200° F	300° F	400° F	
442TT0100	1	1-3/8	1/4	1/8	185	130	100	68	2
442TT0150	1-1/2	1-3/8	1/4	1/8	185	130	100	68	3
442TT0200	2	1-9/16	1/4	1/8	185	130	100	68	7
442TT0250	2-1/2	2-1/4	5/16	1/8	185	130	100	68	10
442TT0300	3	2-1/4	3/8	3/16	185	130	100	68	12
442TT0400	4	2-5/8	1/2	1/4	185	130	100	68	18
442TT0500	5	3-1/4	1/2	1/4	185	130	100	68	24
442TT0600	6	2-3/4	1/2	1/4	185	130	100	68	29
442TT0800	8	4	1/2	1/4	164	112	87	60	47
442TT1000	10	5-1/4	1/2	1/4	164	112	87	60	64
442TT1200	12	6	1/2	1/4	70	40	30	22	115

3 Arch Style

MODEL #	JOINT SIZE I.D. (IN)	FACE-TO-FACE (IN)	MAXIMUM AXIAL TRAVERSE (IN)	MAXIMUM OFFSET (IN)	PRESSURE (PSI) VS. TEMPERATURE				GROSS WT. (LBS)	MAX TEMP FOR FULL VAC. (°F)
					70° F	200° F	300° F	400° F		
443TT0100	1	1-3/4	1/2	1/4	138	90	64	45	2	250
443TT0150	1-1/2	2	1/2	1/4	138	90	64	45	4	250
443TT0200	2	2-3/4	3/4	3/8	138	90	64	45	8	220
443TT0250	2-1/2	3-3/16	3/4	3/8	138	90	64	45	11	200
443TT0300	3	3-5/8	1	1/2	138	90	64	45	13	180
443TT0400	4	3-5/9	1	1/2	138	90	64	45	19	175
443TT0500	5	4	1	1/2	138	90	64	45	25	160
443TT0600	6	4	1-1/8	9/16	138	90	64	45	30	155
443TT0800	8	6	1-1/8	9/16	120	80	57	38	48	150
443TT1000	10	7	1-1/8	3/8	82	52	39	30	80	150
443TT1200	12	7-7/8	1-3/16	5/16	82	52	40	30	120	150

FLUE DUCTS

Expansion Joint



Non-Metallic Expansion Joints

EFP offers a complete line of expansion joints, including the related hardware to meet all of your needs.

Elastomeric Expansion Joints

(up to 400° F). Viton, EPDM, and Neoprene. Fabric reinforcement: fiberglass, aramid, and knitted wire.

Fluoropolymer Expansion Joints

(up to 600° F). PTFE/Fiberglass composite material with TEFLON® laminated to the gas side.

Composite Expansion Joints

(up to 1200° F). Multi-layered design consisting of insulating layers, reinforcing plies, vapor barriers with either Fluoropolymer or Elastomeric covers.

Metal Components

EFP offers all of the metalwork, in any configuration that is associated with our expansion joints as well as full factory assembly prior to shipment.

***Please contact us with your specific requirements.**



PIPE ALIGNMENT GUIDES

Standard Spider Type



Pipe Alignment Guides should always be used in conjunction with expansion joints. Pipe alignment guides help to control the motion of pipe and expansion joints, insuring that the joint is subject only to the deflection for which it was designed. Unguided piping, under pressure, will tend to buckle, sometimes severely. This buckling would deter the expansion joints from working properly. Guides permit unobstructed axial movement of the pipe while restricting lateral, angular, or buckling movements.

Standard spider guides are manufactured to accommodate specific amounts of movement and insulation. A pipe guide assembly consists of an anchored housing and a sliding spider that is attached to the pipe. The spider moves through the housing as the pipe expands and contracts. Guides are carbon steel painted for rust protection. Additional items in this series include pre-insulated guides, pipe slides and bases, anchor clamps, baseboard fin-tube guides, baseboard anchors, and hinged series.

It is recommended that an expansion joint be located as near to an anchor as possible. The first guide* should be located within 4 pipe diameters of the expansion joint (see Figure 1). The second guide should be located within 14 pipe diameters of the expansion joint. The remaining guides are placed at the appropriate distance shown in the INTERMEDIATE GUIDE SPACING CHART (see Figure 2).

*Note: When using pipe alignment guides in conjunction with Externally Pressurized expansion joints, the first guide can be eliminated due to the internal guides in the expansion joints.

Figure 1 Minimum Guide Spacing

Typical layout with expansion joints and proper guide spacing.

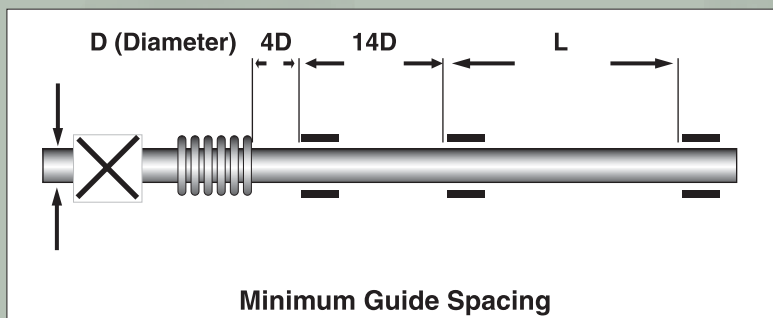

Figure 2 Guide Spacing Ft. Steel Pipe Guide Spacing

Pipe Size	Max distance from bellows to 1st guide/anchor	Approx. distance from 1st to 2nd guide	Approximate distance between additional pipe guides (in feet)			
			@50 PSI	@100 PSI	@150 PSI	@300 PSI
1"	4"	1'4"	21'	15'	12'	10'
1-1/4"	5"	1'5"	23'	17'	13'	12'
1-1/2"	6"	1'9"	28'	20'	17'	13'
2"	8"	2'4"	32'	23'	18'	15'
2-1/2"	10"	2'11"	35'	28'	22'	20'
3"	1'	3'6"	38'	28'	23'	17'
3-1/2"	1'2"	4'1"	45'	35'	27'	19'
4"	1'4"	4'8"	52'	38'	31'	22'
5"	1'8"	5'8"	63'	45'	38'	25'
6"	2'	7'	68'	48'	40'	28'
8"	2'8"	9'4"	87'	62'	45'	38'
10"	3'4"	11'8"	107'	75'	60'	48'
12"	4'	14'	118'	85'	70'	50'
14"	4'8"	16'4"	122'	88'	72'	55'
16"	5'4"	18'8"	137'	96'	80'	60'
18"	6'	21'	145'	105'	85'	65'
20"	6'8"	23'4"	160'	118'	90'	70'
24"	8'	28'	181'	125'	105'	75'

Copper Tube Guide Spacing

Tube Size†	Max distance from bellows to 1st guide/anchor	Approx. distance from 1st to 2nd guide	Maximum Spacing for Intermediate Guides for Copper Tube (Feet)		
			25 PSI	50 PSI	70 PSI
1/2"	2"	7"	5'	4'	3'
3/4"	3"	10-1/2"	7'	6'	5'
1"	4"	1'2"	9'	8'	6'
1-1/4"	5"	1'5-1/2"	14'	11'	9'
1-1/2"	6"	1'9"	14'	11'	9'
2"	8"	2'4"	19'	14'	12'
2-1/2"	10"	2'11"	23'	17'	15'
3"	1'	3'6"	27'	20'	18'
4"	1'4"	4'8"	31'	23'	21'

† Note: For type "M" tubing. For type "L" tubing spacing may be increased by 10%. For type "K" tubing spacing may be increased by 20%.

Special pipe guides not listed are available upon request. Use the 1" thickness column when no insulation is required. **Copper tube guides require dielectric spacers.**



Standard Series

PIPE SIZE	INSULATION THICKNESS ALLOWED FOR						
	1"	1 - 1/2"	2"	2 - 1/2"	3"	3 - 1/2"	4"
1/2"	004-104-4	004-104-4	004-205-4	004-208-4	004-308-4	004-308-4	004-410-4
3/4"	006-104-4	006-605-4	006-206-4	006-308-4	006-308-4	006-410-4	006-410-4
1"	010-104-4	010-605-4	010-206-4	010-308-4	010-308-4	010-410-4	010-410-4
1 - 1/4"	012-104-4	012-605-4	012-206-4	012-308-4	012-308-4	012-410-4	012-410-4
1 - 1/2"	014-105-4	014-105-4	014-206-4	014-308-4	014-308-4	014-410-4	014-410-4
2"	020-106-4	020-606-4	020-208-4	020-208-4	020-310-4	020-310-4	020-412-4
2 - 1/2"	024-106-4	024-106-4	024-208-4	024-208-4	024-310-4	024-310-4	024-412-4
3"	030-106-4	030-208-4	030-208-4	030-310-4	030-310-4	030-412-4	030-412-4
4"	040-108-4	040-108-4	040-208-4	040-210-4	040-312-4	040-312-4	040-414-6
5"	050-110-4	050-110-4	050-210-4	050-312-4	050-312-4	050-314-6	050-416-6
6"	060-110-4	060-110-4	060-110-4	060-212-4	060-314-6	060-416-6	060-416-6
8"	080-112-4	080-112-4	080-212-4	080-316-6	080-316-6	080-418-6	080-418-6
10"	100-216-6	100-216-6	100-214-6	100-318-6	100-318-6	100-420-6	100-420-6
12"	120-218-6	120-218-6	120-216-6	120-320-6	120-320-6	120-422-8	120-422-8
14"	140-220-6	140-220-6	140-218-6	140-220-6	140-322-8	140-322-8	140-424-8
16"	160-222-8	160-222-8	160-222-8	160-222-8	160-324-8	160-324-8	160-426-8
18"	180-224-8	180-224-8	180-224-8	180-224-8	180-326-8	180-326-8	180-428-8
20"	200-226-8	200-226-8	200-226-8	200-226-8	200-330-8	200-330-8	200-330-8
24"	240-230-8	240-230-8	240-230-8	240-230-8	-----	-----	-----

* Pipe guide sizes not listed are available upon request.

Pre-Insulated Series



PIPE SIZE	INSULATION THICKNESS			
	1 - 1/2"	2"	3"	4"
1/2"	004-106-61	004-208-61	004-410-61	004-412-61
3/4"	006-106-61	006-208-61	006-310-61	006-412-61
1"	010-106-61	010-208-61	010-310-61	010-412-61
1 - 1/4"	012-108-61	012-208-61	012-310-61	012-412-61
1 - 1/2"	014-108-61	014-210-61	014-212-61	014-412-61
2"	020-108-61	020-210-61	020-312-61	020-414-61
2 - 1/2"	024-110-61	024-210-61	024-312-61	024-414-61
3"	030-110-61	030-210-61	030-312-61	030-416-61
4"	040-110-61	040-212-61	040-314-61	040-416-61
5"	050-112-61	050-212-61	050-316-61	050-416-61
6"	060-112-61	060-214-61	060-316-61	060-418-61
8"	080-116-61	080-216-61	080-318-61	080-420-61
10"	100-118-61	100-218-61	100-320-61	100-422-61
12"	120-120-61	120-220-61	120-322-61	120-424-61
14"	140-120-61	140-222-61	140-324-61	140-426-61
16"	160-122-61	160-224-61	160-326-61	160-428-61
18"	180-124-61	180-226-61	180-330-61	180-430-61

TEFLON® HOSE

Medium Pressure Smooth Bore Hose



Smooth bore TEFLON® hose is constructed of an extruded inner-core of virgin PTFE with T-304 stainless steel wire braid.

Medium Pressure Smooth Bore Hose

Temperature Range

Intermittent Service -100° F to 500° F (-73° C to 260° C)

Continuous Service -65° F to 450° F (-54° C to 232° C)

Meets or exceeds SAE 100R14 specifications.

General Purpose Smooth Bore TEFLON® * Hose

Smooth bore TEFLON® hose has been the universal problem solver of industry for many decades. Through a process known as cold head extrusion, tetrafluoroethylene powder is transformed into a smooth tube of PTFE.

The industry standard is U17T. It has been widely specified for an endless variety of applications including automotive, food processing, pharmaceutical, chemical and petrochemical. It can be found in factories, on trucks and buses, automobiles on and off road, in laboratories, in endless manufacturing situations; anywhere that the limitations of rubber, metal and synthetic hoses make PTFE hose the only solution.

***Contact us for higher pressure assemblies or different tube and braid requirements.**



Medium Pressure Smooth Bore TEFLON® Hose

Smooth Bore TEFLON® Hose

HOSE PART NUMBER	HOSE SIZE	AVERAGE I.D. (IN)	AVERAGE O.D. (IN)	OPERATING PRESSURE (PSI)	BURST PRESSURE (PSI)	BEND RADIUS (IN)	WEIGHT (LBS/FT)	MAXIMUM CONTINUOUS LENGTH (IN/FT)
U17T-03	3/16"	.125	.250	3000	12000	2	.047	300
U17T-04	1/4"	.187	.312	3000	12000	2	.077	400
U17T-05	5/16"	.250	.375	3000	12000	3	.098	300
U17T-06	3/8"	.312	.445	2500	10000	4	.110	300
U17T-07	7/16"	.375	.503	2250	9000	4.5	.124	300
U17T-08	1/2"	.405	.549	2000	8000	5.2	.124	200
U17T-10	5/8"	.500	.648	1500	6000	6.5	.154	180
U17T-12	3/4"	.625	.778	1200	4800	7.7	.170	150
U17T-14	7/8"	.750	.885	1100	4400	8.2	.198	100
U17T-16	1"	.875	1.030	1000	4000	9	.273	100
U17T-18	1-1/8"	1.000	1.135	900	3600	10	.305	75
U17T-20	1-1/4"	1.125	1.290	750	3000	16	.350	75



Engineered Flexible Products offers a wide variety of standard fittings for medium pressure, smooth bore PTFE hoses. All such fittings are uniquely designed to accommodate either swaging or crimping with the same insert and collar, eliminating the need for double inventory.

This flexibility of design allows for a wide variety of application needs while maintaining the full integrity and quality of the fitting. Either attachment method provides for the full rated catalog performance of the finished assembly.

We also offer many adapters in NPT, JIC & SAE to customize your assemblies.

Female JIC/SAE Swivel Fittings

STAINLESS STEEL	BRASS	HOSE SIZE	THREAD	A OVERALL LENGTH (IN)	B DEDUCT LENGTH (IN)	C NOMINAL ID (IN)
100203	110203	-03	3/8-24	1.31	.50	.095
100204	110204	-04	4/16-20	1.33	.50	.156
100205	110205	-05	1/2-20	1.40	.56	.207
100206	110206	-06	9/16-18	1.56	.63	.277
100208	110208	-08	3/4-16	1.72	.69	.358
100210	110210	-10	7/8-14	1.99	.77	.469
100212	110212	-12	1 1/16-12	2.13	.79	.594
100216	110216	-16	1 5/16-12	2.37	.84	.812

Male NPT Fittings

STAINLESS STEEL	BRASS	HOSE SIZE	THREAD	A OVERALL LENGTH (IN)	B DEDUCT LENGTH (IN)	C NOMINAL ID (IN)
100003	100003	-03	1/8-27	1.26	.80	.095
100104	100104	-04	1/8-27	1.26	.80	.156
100004	100004	-04	1/4-18	1.47	1.02	.156
100005	100005	-05	1/4-18	1.47	1.02	.207
100106	100106	-06	1/4-18	1.60	1.05	.277
100006	100006	-06	3/8-18	1.63	1.08	.277
100108	100108	-08	3/8-18	1.68	1.08	.358
100008	100008	-08	1/2-14	1.93	1.32	.358
100010	100010	-10	1/2-14	2.05	1.35	.469
100012	100012	-12	3/4-14	2.21	1.44	.594
100016	100016	-16	1-11 1/2	2.56	1.65	.812

“STAMPED” – EFP HOSE PLANNING GUIDE

Consider

Size/Hose & Fittings

Temperature

Alloy/Hose & Fittings

Motion & Application

Pressure

End Fitting Attachment

Developed Assembly Length

Check for

- Size of existing piping and mating fittings type and size
 - Flow requirements
- Maximum allowable service temperature rating for hose and fitting alloys
 - Reduced operating pressures at elevated temperature
- Corrosion resistance of hose and fittings alloys for the media conveyed
 - Maximum service temperature
 - Maximum pressure and temperature
- Type of motion, angular, axial, offset, radial, random, vibration, amount and frequency
 - Hose type best suited for application
- Burst, test and operating pressure constant, pulsating or shock
 - Operating pressure at elevated temperature
- Methods applicable to type and alloy of hose and fittings
 - Maximum temperature for alloys and methods of attachment
- Minimum hose live length for type of motion
- Hose assembly length with fittings (overall length)

EXPANSION JOINT PLANNING GUIDE

Primary Information

Quantity: _____ **Size:** _____
Length: _____ (hot or cold
(please indicate by checking box)

Pressure: _____ psig or _____
Design or Operating

Temperature: _____ °F or _____ °C.

System Location: Hanging Ground
Tunnel Pipe Rack Other: _____

Service: (select one)
Thermal Expansion
Stress Reduction
(including seismic or settling)
Vibration (which plane _____)
(RPM frequency amplitude)

Motions:
Compression: Extension: Lateral:
Angular: Torsional: (ball/slip joint only)

Media flowing through joint: _____
Flow Velocity _____ (fps, fpm, cfm, scfm)

System materials of Construction:

Pipe Wall thickness
Duct OD or ID

End Fittings:

Flanges: Rating _____ Type _____
Fixed Rotating Grade
Weld Ends: _____ Sch. _____ Grade _____
Grooved Ends: _____ Sch. _____ Grade _____
Square cut pipe or duct: _____
Other: _____

Horizontal Vertical Other _____
Rods Liner Shroud Stops
Universal Hinge Gimbal
Anchor Base (main intermediate)
Pressure Balanced Pantograph

Additional Information

Specification: _____
(EJMA, ASME B31.1, ASME B31.3, ASME Section VIII, PED)

New: or **Replacement:**

Delivery:
Current manufacturer: _____
Current part number: _____
Current life/comments: _____

Frequency of system cycling: _____

Driven by: Price: or Quality:
End user: **Contractor:** Other: _____

Special test pressure: _____, psig or _____

Special spring rates desired:

Compression: _____ lbs/in
Extension: _____ lbs/in
Lateral: _____ lbs/in
Angular: _____ in-lbs/degree
Torsional: _____ in-lbs/degree

Special paint:
(high-temperature aluminum and black enamel std.)

Special surface preparation:

Special packaging:
Export crate: Carrier: Terms: Dlv:

Special Conditions or Information: _____

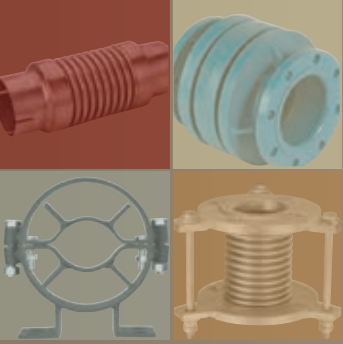

5331 QUAM AVE. N.E. | ST. MICHAEL, MN 55376

TOLL FREE: 1-877-769-8262 | VOICE: 763-201-2151 | FAX: 763-201-2134

Where everything gets connected.



WWW.ENGINEEREDFLEX.COM

It is our mission at Engineered Flexible Products, Inc. to be honest, straight forward, and faithful to our customers, vendors and employees. We strive to be the leader in our industry and we will only sell quality products to our customers.

It is our goal to meet our customers' needs for consistent quality and superior service over the long term while providing a safe and enjoyable work atmosphere for our employees. We treat our employees, customers and vendors with the respect they deserve, thereby assuring the future of our company.