



CLEMCO® CPF BREATHING AIR FILTERS



PART NUMBERS AND SCHEMATICS GUIDE

Company Profile

Allredi was formed in the early 2020, when two of the largest distributors in the blasting, coating, safety, and environmental industry, APE Companies and Marco Group International, joined forces. While the qualities both companies are known for have not changed, a lot about our business is new. New abilities. New agilities. New ways to help you win. This calls for a new name, Allredi.

This name exemplifies what we have become. It is completely oriented to the needs of our customers. To your needs. It says that when you call us for anything – products, service, expert advice, anything – you can consider it done. Or even better, Allredi done.

We are your right-now supplier. From skills to SKUs, we deliver the goods fast. So you can be more agile every minute, every day. This is who we are. This is what our new name means. Go ahead and expect excellence, because we're bringing it.

Our Mission and Vision

To be the industry's preferred partner in surface preparation solutions through unrivaled technical expertise, customer experience, product availability, and tailored service offerings.

The Allredi Difference

- **Industry Experience** – With Allredi on your team, you have access to expertise which can only come from decades of industry leadership. We have organized our engineering department, production specialists, customer operations, and safety support into a "Center of Competence." As an Allredi customer, you have access to hundreds of years of cumulative experience related to your operations.
- **Manufacturing Excellence** – Allredi is a U.S. based manufacturer of equipment for the Surface Preparation and Protective Coatings industries. Allredi's engineers benchmark the industry to ensure that we design and manufacture superior products that set the "Gold Standard" for performance, safety, and quality.
- **Legendary Customer Service** – Allredi's legendary customer service team is staffed by friendly, highly-trained individuals who are focused on providing the highest level of product support, order accuracy, and customer satisfaction.
- **Product Availability** – We stock over 10,000 SKU's and have over 45 shipping locations to serve North American and International markets for all major brands of blasting, coating, environmental, and safety equipment. Allredi is your right-now supplier, so you can keep your projects moving. From our foundation of strong relationships, we have built a nationwide network that puts vast inventory and ready service close to our customers. We provide advanced expertise, and we deliver the goods fast – so you can easily access the products and services you need to be more agile every minute, every day.
- **Technology Leadership** – Our website provides: Operator's Manuals, Part Numbers and Schematics Guides, SDS information, and key product features and specifications, providing access to information 24/7.

TABLE OF CONTENTS

Company Profile	2
Table of Contents	3
Clemco® CPF Breathing Air Filters	4-12
Part Numbers	4-5
Part Numbers & Schematics	6-9
CPF-20	6-7
CPF-80	8-9
Optional Accessories	10-12
Maintenance Notes	13-15

PART NUMBERS

CLEMCO® CPF BREATHING AIR FILTERS		
Part Numbers	Style	Number of Outlets
10C03578	Stationary, with Regulator	2-Outlet
10C03577	Stationary, without Regulator	2-Outlet
10C03527	Stationary, with Regulator	6-Outlet

CLEMCO® CPF BREATHING AIR FILTERS



10C03578



10C03577



10C03527

PART NUMBERS & SCHEMATICS GUIDE

Clemco® CPF-20 Breathing Air Filter

Item #	Part #	Description
Fig. 1		
—	10C03578 10C03577	Clemco CPF-20 Breathing Air Filter with Regulator Clemco CPF-20 Breathing Air Filter without Regulator <i>Does Not Include Item #20</i>
1	10C03623	Handle Strap
2	10C00024B	1/4" NPT 0 – 160 psi Pressure Gauge
3	10C01909	Pressure Relief Valve
4	10C22843	3/8" NPT Male Branch Tee
5	10105326 10C03547	Marco Filter Cartridge (<i>Alternative</i>) Filter Cartridge
6	10C03252	3/8" NC x 1" Hex Head Cap Screw
7	10C03310	3/8" I.D. x 1-1/4" O.D. Washer
8	10C03311	3/8" NC Hex Nut
9	10C01993	1/4" Petcock
10	10C03557	Base Bracket
11	10C03532	1" NPT Pipe Plug
12	10C03515	1/2" SAE Flat Washer
13	10C03511	1/2" NC Hex Nut
14	10C08942	Gasket and O-Ring Kit
15	10C03318	3/8" Lock Washer
16	10C03720	3/8" NPT x 2" Brass Nipple
17	10C03584	Air Filter Cap
18	10C03536	3/8" NPT Brass Plug
19	10C03545	Filter Cap Stud
20	10C03594	Pressure Regulator
—	10C03582	Regulator Kit <i>Includes Item #'s: 4, 16, 18, and 20</i>
—	105V485	Features and Specifications Guide – Clemco® CPF Air Filters
—	106M485	Part Numbers and Schematics Guide – Clemco® CPF Air Filters
—	109V485	Operator's Manual – Clemco® CPF Air Filters

PART NUMBERS & SCHEMATICS GUIDE

Figure 1: Clemco® CPF-20 Breathing Air Filter

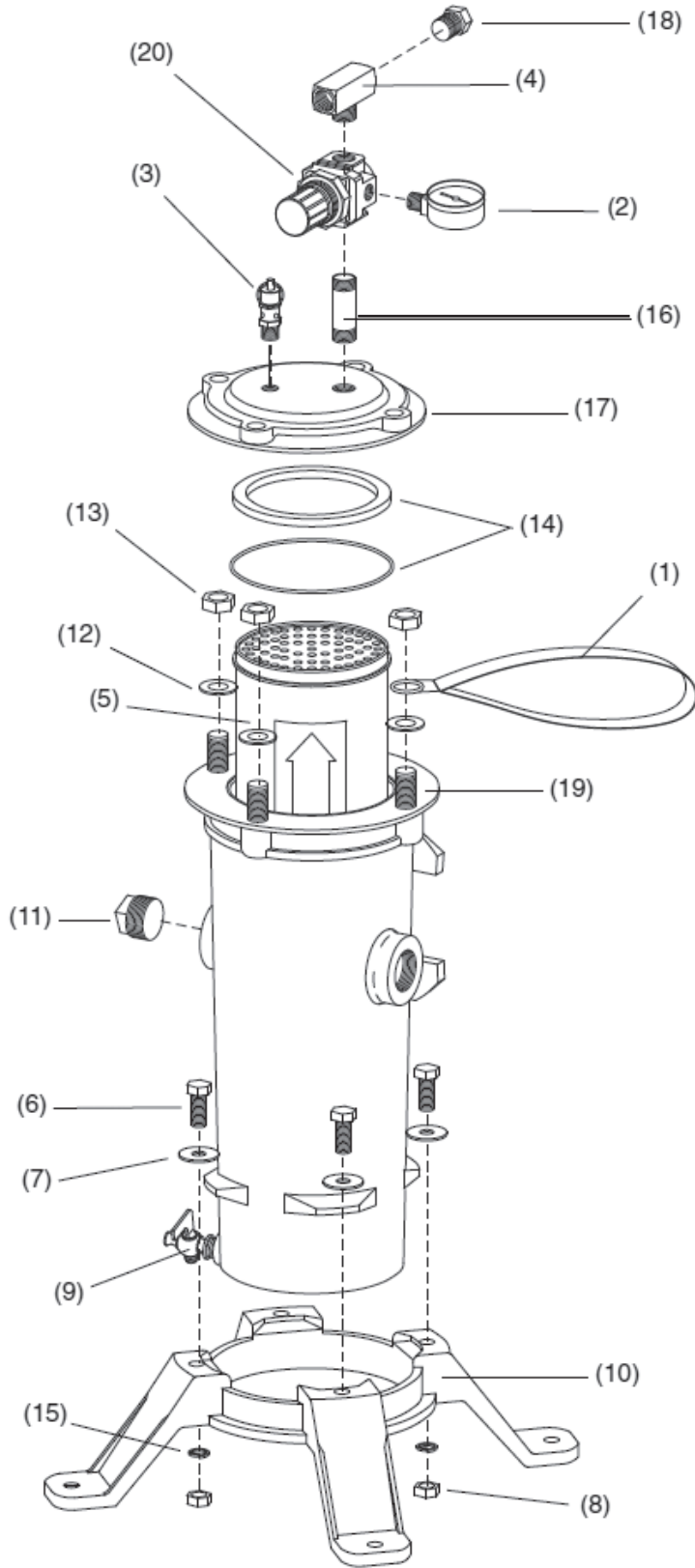

PART NUMBERS & SCHEMATICS GUIDE

Clemco® CPF-80 Breathing Air Filter







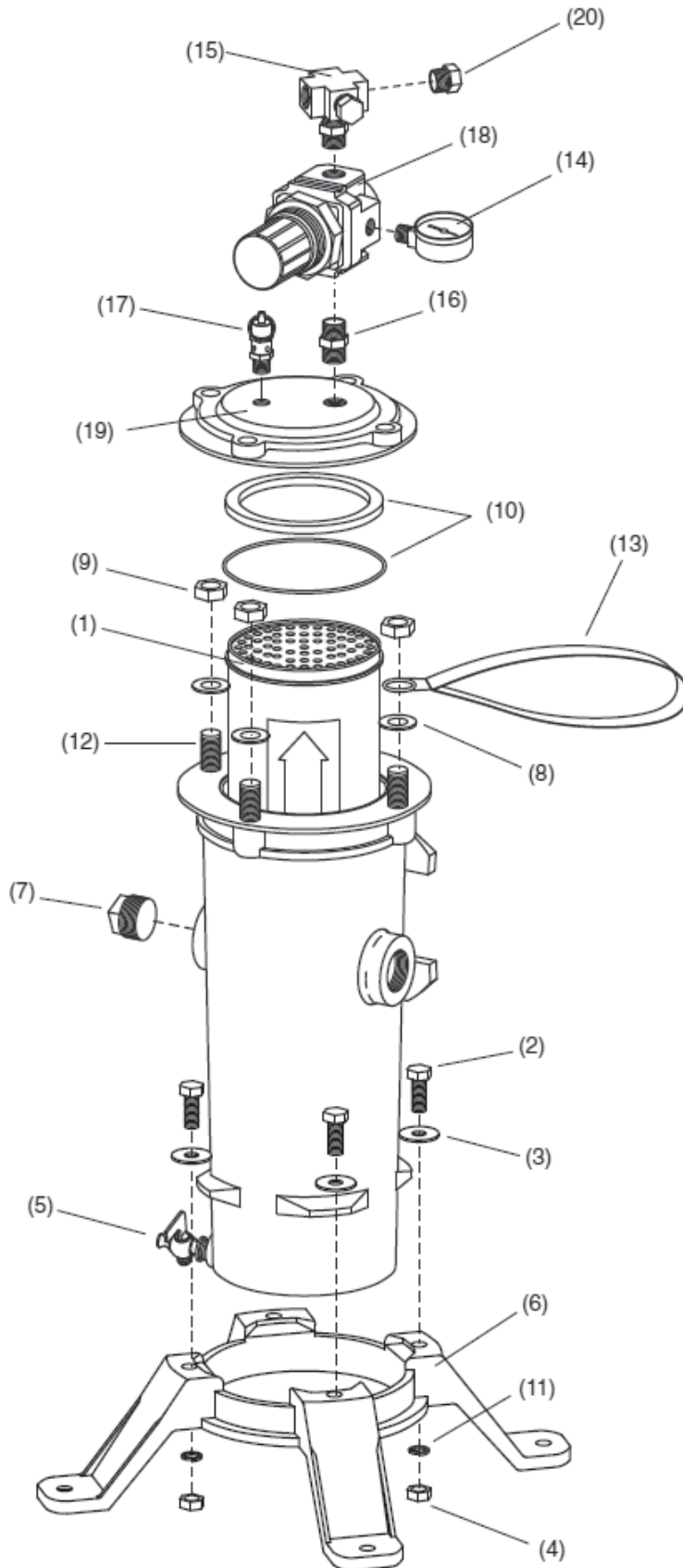

Item #	Part #	Description
Fig. 2		
—	10C03527	Clemco CPF-80 Breathing Air Filter with Regulator
1	10105326 10C03547	Marco Filter Cartridge (<i>Alternative</i>) Filter Cartridge
2	10C03252	3/8" NC x 1" Hex Head Cap Screw
3	10C03310	3/8" I.D. x 1-1/4" O.D. Washer
4	10C03311	3/8" NC Hex Nut
5	10C01993	1/4" Petcock
6	10C03557	Base Bracket
7	10C03532	1" NPT Pipe Plug
8	10C03515	1/2" SAE Flat Washer
9	10C03511	1/2" NC Hex Nut
10	10C08942	Gasket and O-Ring Kit
11	10C03318	3/8" Lock Washer
12	10C03545	1/2" NC x 2" Stud
13	10C03623	Handle Strap
14	10C00024B	1/4" NPT 0 – 160 psi Pressure Gauge
15	10C22941	3/8" NPT Cross Manifold
16	10C03596	3/8" NPT Hex Nipple
17	10C01909	1/4" NPT Relief Valve
18	10C22939	3/8" NPT Large Body Pressure Regulator
19	10C03584	CPF Filter Cap
20	10C03536	3/8" NPT Brass Plug
—	10C23477	Pressure Regulator Conversion Kit (Converts old style CPF-80 Cap to New Style) <i>Includes Item #'s: 13, 15, 18, and 19</i>
—	105V485	Features and Specifications Guide – Clemco® CPF Air Filters
—	106M485	Part Numbers and Schematics Guide – Clemco® CPF Air Filters
—	109V485	Operator's Manual – Clemco® CPF Air Filters

PART NUMBERS & SCHEMATICS

Figure 2: Clemco® CPF-80 Breathing Air Filter



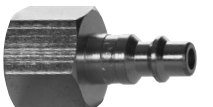

OPTIONAL ACCESSORIES

		BREATHING LINE FITTINGS AND QUICK-DISCONNECT COUPLINGS
Part Numbers	Description	
	10BV11	3/8" Male x 3/8" Male Hose to Hose Connector Hex Nipple <i>Replace 10BV11 with 10BV27 if not using 10B4696 Starter Hose</i>
	10BV12	3/8" Male NPT Pipe Thread to 1/4" Male Hose Adapter Hex Nipple <i>Included in 10BV27</i>
	10BV13	3/8" Male NPT Pipe Thread to 3/8" Male Hose Adapter Hex Nipple <i>Comes on 10B5454, 10B5457 and 10B5458</i>
	10BV14	1/4" Female Quick-Disconnect Coupling, Shut-Off with 1/4" Female Pipe Thread <i>Included in 10BV27</i>
	10BV19	1/4" Female Snap-Tite Quick-Disconnect Coupling, Shut-off with 1/4" Female Pipe Thread
	10BV15	1/4" Female Quick-Disconnect Coupling, Shut-Off with 3/8" Male Pipe Thread <i>Install on airline filter to make quick-disconnect</i>
	10BV27	1/4" Female Industrial Interchange Coupling Assembly <i>Includes 10BV12 and 10BV14</i> <i>Replaces 10BV13 at the hood to make quick-disconnect if not using 10B4696 Starter Hose</i>
	10BV17	1/4" Male Industrial Interchange Quick-Disconnect Coupling, 3/8" Female NPT Pipe Thread <i>Add to 10BV13 to make quick-disconnect at airline filter</i>
	10BS19442	1/4" Male Snap-Tite Quick-Disconnect Coupling With 1/4" Female NPT Pipe Thread
	10BS19432	1/4" Male Schrader® Coupling with 1/4" Male Pipe Thread

OPTIONAL ACCESSORIES

		3/4" I.D. X 1-1/4" O.D. AIR HOSE				
	Part Numbers	Length	Hose I.D.	Hose O.D.	Working Pressure	Hose Cover Color
	10AH034	Per Ft.	3/4"	1-1/4"	200 psi	Red

		3/4" I.D. X 1-1/4" O.D. AIR HOSE WITH COUPLINGS INSTALLED					
	Part Numbers	Length	Hose I.D.	Hose O.D.	Working Pressure	Hose Cover Color	Couplings
	10AH034AC	50 Ft.	3/4"	1-1/4"	200 psi	Red	2-Lug Crimped On

		MALE HOSE END COUPLING AND GASKET FOR 3/4" I.D. AIR HOSE					
	Part Numbers	Hose I.D.	Material	Coupling Style	GASKET		
					Rubber Gasket	Gasket I.D.	Gasket O.D.
	10HE1	3/4"	Zinc-Plated Iron	2-Lug	10UG2	3/4"	1-3/8"

		BOSS CLAMP FOR 3/4" I.D. AIR HOSE		
	Part Numbers	Hose I.D.	Hose O.D. Range	Material
	10A9	3/4"	1-1/8"–1-5/16"	Plated Steel

OPTIONAL ACCESSORIES

		1" I.D. X 1-1/2" O.D. AIR HOSE				
	Part Numbers	Length	Hose I.D.	Hose O.D.	Working Pressure	Hose Cover Color
	10AH100	Per Ft.	1"	1-1/2"	200 psi	Red

		1" I.D. X 1-1/2" O.D. AIR HOSE WITH COUPLINGS INSTALLED						
	Part Numbers	Length	Hose I.D.	Hose O.D.	Working Pressure	Hose Cover Color	Couplings	Band Clamps
	10AH100AC	50 Ft.	1"	1-1/2"	200 psi	Red	2-Lug Crimped On	

		MALE HOSE END COUPLING AND GASKET FOR 1" I.D. AIR HOSE					
	Part Numbers	Hose I.D.	Material	Coupling Style	GASKET		
					Rubber Gasket	Gasket I.D.	Gasket O.D.
	10HE2	1"	Plated Iron	2-Lug	10UG2	3/4"	1-3/8"

		HAMMER-LOCK FITTING FOR 1" I.D. AIR HOSE	
	Part Numbers	Hose I.D.	Material
	10DXGF36	1"	Plated Steel

		BOSS CLAMP FOR 1" I.D. AIR HOSE		
	Part Numbers	Hose I.D.	Hose O.D. Range	Material
	10A14	1"	1-1/2"–1-13/16"	Plated Steel

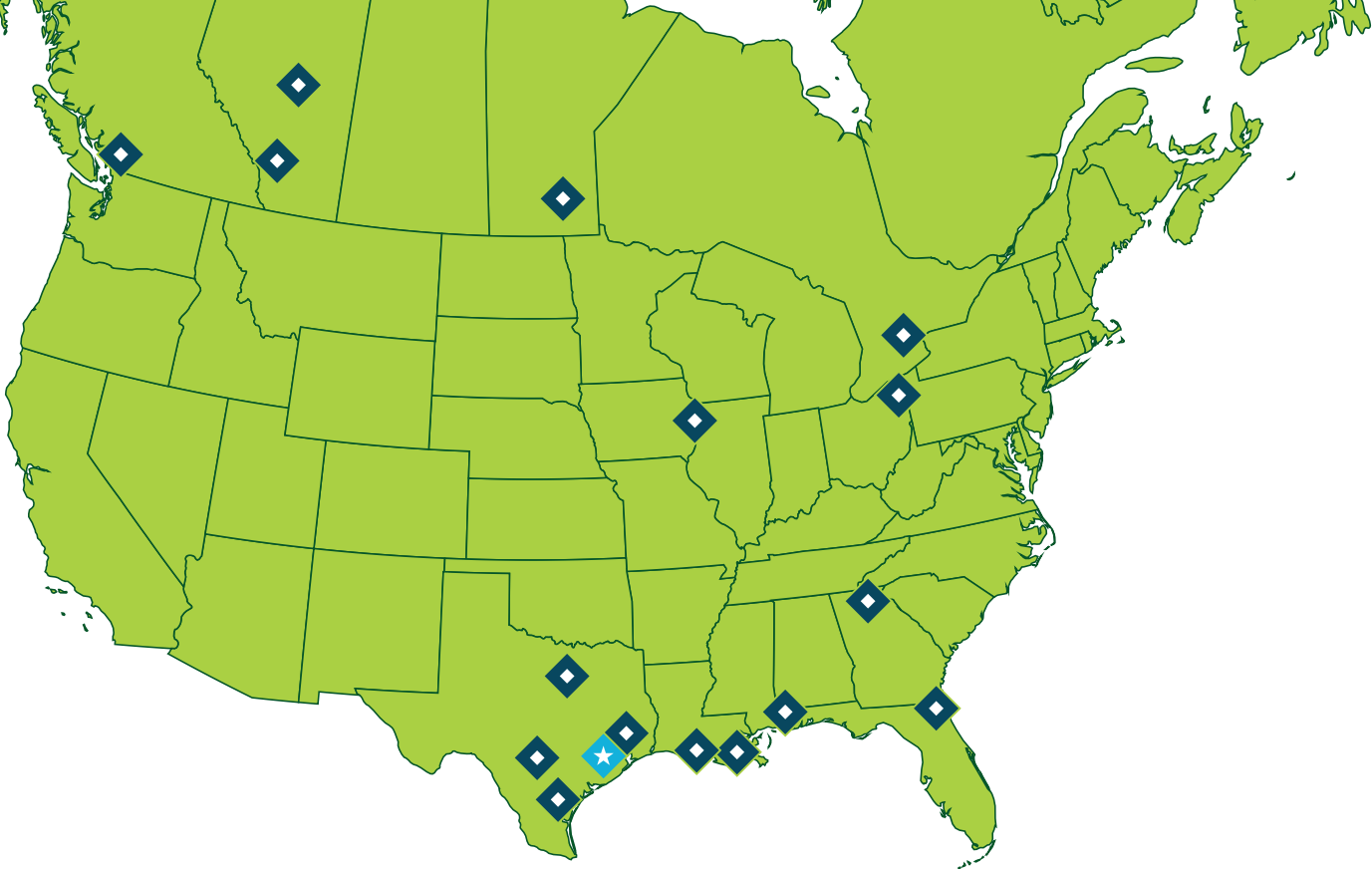

ALLREDI THERE

Serving these industries: Bridge, Pipeline, Tank & Tower, Concrete Services, Rail, Shipyard & Marine, Pools & Fountains and Foundry

UNITED STATES

Pasadena, TX (Headquarters)

844.361.7038

Beaumont, TX

409.722.1284

Bristol, PA

215.826.8080

Corpus Christi, TX

361.887.2038

Davenport, IA

563.324.2519

Deer Park, TX

(Service & Rental Location)

281.930.0905

Duluth, GA

800.535.4564

Gonzales, LA

225.647.7575

Harvey, LA

504.367.8090

Houma, LA

985.580.4273

Jacksonville, FL

904.262.2120

Lafayette, LA

337.267.1440

Theodore, AL

251.338.7525

Youngstown, OH

330.448.6267

CANADA

Calgary, Alberta

403.279.1924

Coquitlam, BC

604.464.6979

Edmonton, Alberta

780.468.2588 (Manus)

780.425.5510 (Mod-U-Blast)

Hamilton, Ontario

905.527.6000 / 888.794.5665

Mississauga, Ontario

905.890.5837

Winnipeg, Manitoba

204.256.3324

800-252-7848 / WWW.ALLREDI-US.COM

Allredi™ and Marco® are registered trademarks of Allredi, LLC.

All other brand names or marks are used for identification purposes and are trademarks of their respective owners.



Literature #106M485_8/24/22