



Operating Manual
ALTAIR® 4XR
Multigas Detector



Order No.: 10175896/07

Print Spec: 10000005389 (EO)

CR: 800000056866

WARNING!

Read this manual carefully before using or maintaining the device. The device will perform as designed only if it is used and maintained in accordance with the manufacturer's instructions. Otherwise, it could fail to perform as designed, and persons who rely on this device could sustain serious injury or death.

The warranties made by MSA with respect to the product are voided if the product is not installed and used in accordance with the instructions in this manual. Please protect yourself and your employees by following the instructions.

Please read and observe the WARNINGS and CAUTIONS inside. For additional information relative to use or repair, call 1-800-MSA-2222 during regular working hours.

For countries of Russian Federation, Republic of Kazakhstan and Republic of Belarus, the gas detector will be delivered with a passport document that includes valid approval information. On the CD with manual instruction attached to the gas detector the user will find the documents "Type Description" and "Test Method" - appendixes to Pattern Approval Certificate of Measuring instrument, valid in the countries of use.

MSA is a registered trademark of MSA Technology, LLC in the US, Europe and other Countries. For all other trademarks visit <https://us.msasafety.com/Trademarks>.

This product incorporates Bluetooth® wireless technology. The Bluetooth word mark and logos are registered trademarks owned by Bluetooth SIG, Inc., and any use of such marks by MSA is under license. Other trademarks and trade names are those of their respective owners. Versions of this product manufactured July 2022 and later may not contain Bluetooth wireless technology. This will be indicated by the front case of the detector not utilizing a Bluetooth logo. All references in this manual to Bluetooth will not pertain to these versions of the device.

This device complies with part 15 of the FCC Rules. Operation is subject to the following two conditions: (1) This device may not cause harmful interference, and (2) this device must accept any interference received, including interference that may cause undesired operation.

You are cautioned that changes or modifications not expressly approved by the party responsible for compliance could void the user's authority to operate the equipment.

English:

This device complies with RSS-210 of the Industry Canada Rules. Operation is subject to the following two conditions: (1) This device may not cause harmful interference, and (2) this device must accept any interference received, including interference that may cause undesired operation.

French:

Ce dispositif est conforme à la norme CNR-210 d'Industrie Canada applicable aux appareils radio exempts de licence. Son fonctionnement est sujet aux deux conditions suivantes: (1) le dispositif ne doit pas produire de brouillage préjudiciable, et (2) ce dispositif doit accepter tout brouillage reçu, y compris un brouillage susceptible de provoquer un fonctionnement indésirable.



The Safety Company

1000 Cranberry Woods Drive
Cranberry Township, PA 16066
USA
Phone 1-800-MSA-2222

For your local MSA contacts, please go to our website www.MSAafety.com

Contents

1	Calibration Certification and Conformance	5
1.1	Calibration Certification	5
1.2	Conformance Statement	5
2	Safety Regulations	5
2.1	Correct Use	5
2.2	Liability Information	6
2.3	Safety and Precautionary Measures to be Adopted	6
2.4	Warranty	8
3	Description	10
3.1	Overview	10
3.2	Device Hardware Interfaces	10
3.3	On-Screen Indicators	12
3.4	Battery Care	13
3.5	Viewing Additional Pages	15
3.6	Sensor Missing Alarm	17
3.7	Sensor End of Life Warning	17
3.8	Sensor End of Life Indicator	17
3.9	Monitoring Toxic Gases	17
3.10	Monitoring Oxygen Concentration	18
3.11	Monitoring Combustible Gases	19
4	Operation	19
4.1	Environmental Factors	19
4.2	Turning ON and Fresh Air Setup	20
4.2.1	Fresh Air Setup (FAS)	23
4.3	Measurement Mode [Normal Operation]	24
4.4	Device Setup	24
4.5	Bluetooth Operation	28
4.6	Data Logging	30
4.7	Function Tests	30
4.8	Bump Test	30
4.9	Bump LED	31
4.10	Calibration	31
4.11	Time of Day Testing	34
5	Maintenance	34
5.1	Troubleshooting	35
5.2	Live Maintenance Procedure - Replacing and Adding a Sensor	35
5.3	Cleaning	37
5.4	Storage	37
5.5	Scope of Delivery	37
6	Technical Data	38
6.1	Factory-set Alarm Thresholds and Setpoints	39
6.2	Performance Specification	40
6.3	XCell Sensor Patents	43
7	Ordering Information	45
8	Appendix	47
8.1	Start Up Sequence (Power on)	47
8.2	Fresh Air Setup (FAS)	48

8.3	Reset Screen Controls	49
8.4	Bump Test	51
8.5	Options Setup	52
8.6	Sensor Setup	53
8.7	Calibrations	54
8.8	Alarm Setup	55
8.9	Time and Date Setup	56
8.10	Bluetooth Setup	56

1 Calibration Certification and Conformance

1.1 Calibration Certification

All applicable inspections, testing, and calibrations were performed using NIST traceable equipment, where available, in accordance with MSA's ISO 9001 Certified Quality System. Each material, component, and/or instrument must be installed, operated and maintained in strict accordance with its labels, cautions, warnings, instructions, and within the limitations stated in the supplied instruction manual. Routine calibration checks, equipment inspections, and applicable preventative maintenance measures must be performed to verify that the materials, components, and/or instruments are operating properly. Failure to perform these tasks on a routine basis, or suggested intervals, with specified equipment or methods, may result in inaccurate readings.

1.2 Conformance Statement

MSA certifies that the materials, components, and/or instruments delivered in this shipment conform to all applicable specifications. The items delivered have been processed through the appropriate approved document controlled procedures for Receiving, Manufacturing and Inspection. The materials, components, and/or instruments were inspected, tested, and calibrated, as applicable, per the associated drawings, standards requirements, and/or specifications, and were deemed acceptable by appropriate authorized personnel.

2 Safety Regulations

2.1 Correct Use

The ALTAIR 4XR Multigas Detector is for use by trained and qualified personnel. It is designed to be used when performing a hazard assessment to:

- Assess potential worker exposure to combustible and toxic gases and vapors as well as low level of oxygen.
- Determine the appropriate gas and vapor monitoring needed for a workplace.

The ALTAIR 4XR Multigas Detector can be equipped to detect:

- Combustible gases and certain combustible vapors
- Oxygen-deficient or oxygen-rich atmospheres
- Oxygen for monitoring inertization applications. The device is suitable and certified for the measurement of the oxygen concentration in gas mixtures for inertization according to EN 50104 but without alarm function.
- Specific toxic gases for which a sensor is installed.

NOTE: While the device can detect up to 30% oxygen in ambient air, it is approved for use only up to 21% oxygen.

The ATEX directive is only valid until 25% Vol O₂.

It is imperative that this operating manual be read and observed when using the device. In particular, the safety instructions, as well as the information for the use and operation of the device, must be carefully read and observed. Furthermore, the national regulations applicable in the user's country must be taken into account for a safe use.

WARNING!

- This product is supporting life and health. Inappropriate use, maintenance or servicing may affect the function of the device and thereby seriously compromise the user's life.
- Before use the product operability must be verified. The product must not be used if the function test is unsuccessful, it is damaged, a competent servicing/maintenance has not been made, genuine MSA spare parts have not been used.
- Alternative use, or use outside this specification will be considered as non-compliance. This also applies especially to unauthorized alterations to the product and to commissioning work that has not been carried out by MSA or authorized persons.

Failure to follow these warnings can result in serious personal injury or death.

This equipment has been tested and found to comply with the limits for a Class A digital device, pursuant to part 15 of the FCC Rules.

 These limits are designed to provide reasonable protection against harmful interference when the equipment is operated in a commercial environment.

This equipment generates, uses, and can radiate radio frequency energy and, if not installed and used in accordance with the instruction manual, may cause harmful interference to radio communications.

Operation of this equipment in a residential area is likely to cause harmful interference in which case the user will be required to correct the interference at his own expense.

WARNING!

This is a class A product in accordance with CISPR 22. In a domestic environment, this product may cause radio interference, in which case the user may be required to take adequate measures.

Failure to follow this warning can result in serious personal injury or death.

This Class A digital apparatus complies with Canadian ICES-003.

2.2 Liability Information

MSA accepts no liability in cases where the product has been used inappropriately or not as intended.

The selection and use of this product must be under the direction of a qualified safety professional who has carefully evaluated the specific hazards of the jobsite where it will be used and who is completely familiar with the product and its limitations. The selection and use of this product and its incorporation into the safety scheme of the jobsite is the exclusive responsibility of the employer.

Changes and modifications not expressly approved by the manufacturer will void the user's authority to operate the equipment.

2.3 Safety and Precautionary Measures to be Adopted

WARNING!

Carefully review the following safety limitations and precautions before placing this device in service. Do not alter or modify the device.

Failure to follow this warning can result in serious personal injury or death.

WARNING!

All device readings and information must be interpreted by someone trained and qualified in interpreting device readings in relation to the specific environment, industrial practice and exposure limitations.

Failure to follow this warning can result in serious personal injury or death.

Check Function

Before each day's use, check the function of the device (→ [4.7 Function Tests](#)). MSA recommends carrying out a routine inspection prior to each day's use.

Bluetooth Operation

If your device contains Bluetooth functionality, Bluetooth operation is dependent upon signal availability of the wireless service(s) necessary to maintain the communication link. Loss of wireless signal will prevent communication of alarms and other information to linked devices. Take appropriate precautions in the event a loss of wireless signal occurs.

Perform a Bump Test

Bump test frequency is often stipulated by national or corporate regulations; however, bump testing before each day's use is generally the accepted best safety practice and is therefore MSA's recommendation. The device must pass the bump test. If it fails the test, perform a calibration before using the device.

Perform a bump test (see [4.8 Bump Test](#)) more frequently if the device is subjected to physical shock or high levels of contaminants. Also, perform a bump test more frequently if the tested atmosphere contains the following materials, which may desensitize the combustible gas sensor and reduce its readings:

- Organic silicones
- Silicates
- Lead-containing compounds
- Hydrogen sulphide exposures over 200 ppm or exposures over 50 ppm for one minute.

Check minimum concentration of a combustible gas

The minimum concentration of a combustible gas in air that can ignite is defined as the Lower Explosive Limit (LEL). A combustible gas reading of "XXX" indicates the atmosphere is above 100 % LEL or 5.00 % vol CH₄, and an explosion hazard exists. Move away from hazardous area immediately.

Observe atmosphere

Do not use the device to test for combustible or toxic gases in the following atmospheres as this may result in erroneous readings:

- Oxygen-deficient or oxygen-rich atmospheres
- Reducing atmospheres
- Furnace stacks
- Inert environments
- Atmospheres containing combustible airborne mists/dusts.

Use the device only to detect gases/vapors for which a sensor is installed.

The device is suitable and certified for the measurement of the oxygen concentration in gas mixtures for inertization according to EN 50104 but without alarm function.

Make sure >10% oxygen is present for accurate combustible readings with the catalytic sensor.

Not to be used for gases having a flash point in excess of 38 °C (100 °F)

Do not use the device to test for combustible gases in atmospheres containing vapors from liquids with a high flash point (above 38 °C, 100 °F), as this may result in erroneously low readings.

Physical shock

Recheck calibration if device is subjected to physical shock.

Sensor maintenance

Do not block sensor openings as this may cause inaccurate readings. Do not press on the face of the sensors, as this may damage them and cause erroneous readings. Do not use compressed air to clean the sensor holes, as the pressure may damage the sensors.

Observe Proper Time for Display Stabilizing

Allow sufficient time for device to display accurate reading. Response times vary based on the type of sensor being utilized.

Observe proper battery maintenance

Use only battery chargers made available by MSA for use with this device; other chargers may damage the battery pack and the device. Dispose of in accordance with local health and safety regulations.

2 Safety Regulations

Use of the MSA GALAXY® GX2 Automated Test System is an alternate approved method for charging ALTAIR 4XR devices.

As the battery pack ages, there will be a reduction in usable device runtime.

Risk of explosion: Do not recharge device in hazardous area.

Be Aware of Environmental Conditions

A number of environmental factors may affect the sensor readings, including changes in pressure, humidity and temperature. Pressure and humidity changes also affect the amount of oxygen actually present in the atmosphere.

Be Aware of the Procedures for Handling Electrostatically Sensitive Electronics

The device contains electrostatically sensitive components. Do not open or repair the device without using appropriate electrostatic discharge (ESD) protection. The warranty does not cover damage caused by electrostatic discharges.

Be Aware of the Product Regulations

Follow all relevant national regulations applicable in the country of use.

Be Aware of the Warranty Regulations

The warranties made by MSA The Safety Company with respect to the product are voided if the product is not used and maintained in accordance with the instructions in this manual. Please protect yourself and others by following them. We encourage our customers to write or call regarding this equipment prior to use or for any additional information relative to use or service.

Special Conditions for Safe Usage

- In the event of combustible sensor overrange, the device will enter a Lock Alarm state, which must be reset in a fresh air environment. To reset this alarm, cycle power off and on, in fresh air. Keep the device in the fresh air environment until LEL or CH4 readings have stabilized and then follow the Fresh Air Setup and Zero Calibration instructions contained in this manual.
- The RF radiation power used to activate the RFID tag antenna shall not exceed 6 Watts for EPL Group I applications or 2 Watts for EPL Group IIC applications.

2.4 Warranty

ITEM	WARRANTY PERIOD*
Chassis and electronics	Four years
All sensors unless otherwise specified	Four years
XCell EX-H Sensor	One year
In-Box Accessories including Replacements	Two years

*Period begins date of received shipment.

Specific battery run-time over temperature is not warranted.

This warranty does not cover filters, fuses, etc. As the battery pack ages, there will be a reduction in usable device run time. Certain other accessories not specifically listed here may have different warranty periods. This warranty is valid only if the product is maintained and used in accordance with Seller's instructions and/or recommendations.

The Seller shall be released from all obligations under this warranty in the event repairs or modifications are made by persons other than its own or authorized service personnel or if the warranty claim results from physical abuse or misuse of the product. No agent, employee or representative of the Seller has any authority to bind the Seller to any affirmation, representation or warranty concerning this product. Seller makes no warranty concerning components or accessories not manufactured by the Seller, but will pass on to the Purchaser all warranties of manufacturers of such components.

THIS WARRANTY IS IN LIEU OF ALL OTHER WARRANTIES, EXPRESSED, IMPLIED OR STATUTORY, AND IS STRICTLY LIMITED TO THE TERMS HEREOF. SELLER SPECIFICALLY DISCLAIMS ANY WARRANTY OF MERCHANTABILITY OR OF FITNESS FOR A PARTICULAR PURPOSE.

Exclusive Remedy

It is expressly agreed that Purchaser's sole and exclusive remedy for breach of the above warranty, for any tortuous conduct of Seller, or for any other cause of action, shall be the replacement at Seller's option, of any equipment or parts thereof, which after examination by Seller is proven to be defective.

Replacement equipment and/or parts will be provided at no cost to Purchaser, F.O.B. Seller's Plant. Failure of Seller to successfully replace any nonconforming equipment or parts shall not cause the remedy established hereby to fail of its essential purpose.

Exclusion of Consequential Damage

Purchaser specifically understands and agrees that under no circumstances will seller be liable to purchaser for economic, special, incidental or consequential damages or losses of any kind whatsoever, including but not limited to, loss of anticipated profits and any other loss caused by reason of non-operation of the goods. This exclusion is applicable to claims for breach of warranty, tortuous conduct or any other cause of action against seller.

3 Description

3.1 Overview



Figure 1 Device overview

- | | | | |
|---|--|----|-------------------------------|
| 1 | Datalink Communication port | 8 | Display |
| 2 | Bump LED (green/red) and Fault LED (-yellow) | 9 | Alarm LEDs (4) |
| 3 | Sensor Inlets | 10 | Belt Clip |
| 4 | Horn | 11 | Charging Connection |
| 5 | ▲ Button | 12 | Screws (4) |
| 6 | ▼ Button | 13 | Charge LED (red/green/orange) |
| 7 | ⏻ Button | 14 | Bluetooth Status LED |

The device monitors gases in ambient air and in the workplace.

It is available with a maximum of three sensors, which can display readings for four separate gases (one Two-Tox Sensor can detect two toxic gases with a single sensor).

While the device can detect up to 30% oxygen in ambient air, it is approved for use only up to 21% oxygen.

The alarm levels for the individual gases are factory-set and can be changed through the Setup Menu. These changes can also be made through the GALAXY GX2 Test Stand or MSA Link software. Ensure that the latest version of the GALAXY GX2 firmware or MSA Link software has been downloaded from MSA's website www.msasafety.com.











If gas is present during Fresh Air Setup, the device will fail and enters Normal Operation mode.

3.2 Device Hardware Interfaces

Device operation is dialog driven from the display with the aid of the three function buttons (→ [3.2 Device Hardware Interfaces](#)).

The device has three buttons for user operation. Each button can function as a "soft key", as defined on the display directly above the button.

Button Definitions

Button	Description
	The  button is used to turn device on or off and to confirm user action selections. When the  button and the  button are pressed simultaneously for device start-up, the Options Setup Mode displays.
	The  button is used to move forward through data screens in measuring mode, or as page back and to decrease the values in set-up mode. Holding this button for 3 seconds while in Normal Operation mode activates the InstantAlert alarm.
	The  button is used to reset peak, STEL TWA and acknowledge alarms (where possible) or access calibration in measuring mode. It is also used as page up or to increase the values in set-up mode.

LED Definitions

LED	Description
GREEN/RED (Bump LED)	<p>After a successful Bump Test, the green LED will flash every 15 seconds for a 24-hour period.</p> <p>When the device fails a bump test or when the 24-hour period expires, the red LED flashes every 15 seconds.</p> <p>This option can be turned off through the MSA GALAXY GX2 Test Stand or MSA Link software.</p>
RED (Alarm LED)	The red alarm LEDs are visual indications of an alarm condition or any type of error in the device.
YELLOW (Fault LED)	<p>The yellow fault LED is a visual indication of an device fault condition. This LED turns on with the following conditions:</p> <ul style="list-style-type: none"> • Device memory error • Sensor Missing • Sensor Error
RED/GREEN/ORANGE (Charge LED)	<p>The charge LED is a visual indication of charge status.</p> <ul style="list-style-type: none"> • RED: device is charging • GREEN: charge is complete • ORANGE: problem detected during charging
BLUE (Bluetooth Status)	<p>If your instrument supports Bluetooth, the blue LED is a visual indication of the Bluetooth connection status.</p> <ul style="list-style-type: none"> • Off = Bluetooth OFF or Undiscoverable • Fast Flash = Discoverable Mode • Slow Flash = Connected

Vibrating Alarm

The device is equipped with a vibrating alarm.

Backlight

The backlight automatically activates when any front panel button is pressed. The backlight remains on for the duration of the user-selected timeout. This duration can be set through MSA GALAXY GX2 Test Stand or MSA Link software.

Horn

The horn provides an audible alarm.

3 Description

Operating Beep

This operating beep activates every 30 seconds by momentarily beeping the horn and flashing the alarm LEDs under the following conditions:

- Operating beep is enabled
- Device is in Normal Operation mode
- Device is not in battery warning
- Device is not in gas alarm
- Audible and visual options are enabled

3.3 On-Screen Indicators

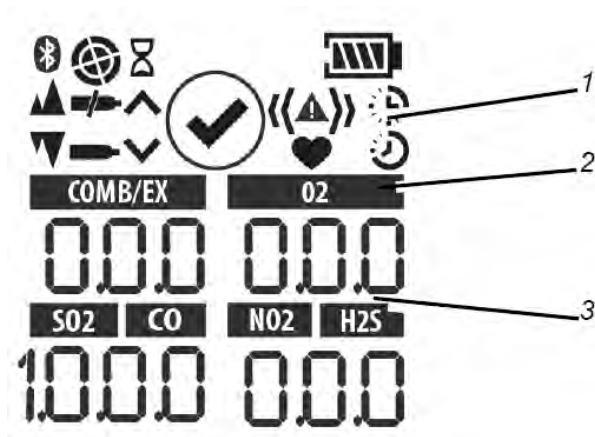





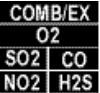











Figure 2 Display

- 1 Graphic Symbols 3 Gas Concentration
 2 Gas Type

	Alarm Symbol – Indicates alarm state
	Motion Alert – Indicates Motion Alert is active
	Bump Check Symbol – Indicates successful bump or cal
	Indicates required interaction
	Battery Condition – Indicates the battery charge level
	Sensor Labels
	Calibration Setup
	Cal Gas Cylinder – Indicates cal gas must be applied

	No Gas Cylinder – Indicates cal gas should not be applied and device must be exposed to fresh air.
	Hourglass – Indicates user should wait
	Minimum – Indicates a minimum value or low alarm
	PEAK Symbol – Indicates a PEAK reading or high alarm
	STEL Symbol – Indicates a STEL alarm
	TWA Symbol – Indicates a TWA alarm
	Sensor life Symbol – Indicates the end of sensor life
	Bluetooth Symbol - Indicates enabled Bluetooth operation (if applicable)

3.4 Battery Care

Battery Life Indicator

The battery condition icon is continuously displayed in the upper right-hand corner of the display. As the battery is depleted, battery icon segments blank until only the battery icon outline remains.

Each indicator segment represents approximately 25 % of the total battery capacity.

Battery Warning

WARNING!

If battery warning alarm activates while using the device, leave the area immediately as the end of battery life is approaching.

Failure to follow this warning can result in serious personal injury or death.

The nominal run-time of the device at room temperature is 24 hours. The runtime with an active Bluetooth connection is approximately 22 hours. The runtime of the device at -20 °C/- 4 °F will be approximately 14 hours.

Actual run-time will vary depending on ambient temperature and alarm conditions.

The alarm levels for the individual gases are factory-set and can be changed through the Setup Menu.

A Low Battery Warning indicates that a nominal 30 minutes of operation remain before the battery's charge is depleted.



The duration of remaining device operation during a Low Battery Warning depends on ambient temperatures.

When the device goes into Low Battery Warning, the:

- battery life indicator flashes
- alarm sounds

3 Description

- alarm LEDs flash
- display shows "LOW BATT" and 
- device repeats this warning every 60 seconds and continues to operate until it is turned off or battery shutdown occurs.

Battery Shut Down

WARNING!

If the battery shutdown alarm activates, stop using the device as it no longer has enough power to indicate potential hazards, and persons relying on this device for their safety could sustain serious personal injury or death.

The device goes into battery shutdown mode 60 seconds before final shutdown (when the batteries can no longer operate the device):

- On the display flashes "BATT ALARM" and 
- Alarm sounds and lights flash; alarm cannot be silenced,
- No other pages can be viewed; after approximately one minute, the device -automatically turns off.

When battery shutdown condition occurs:

1. Leave the area immediately.
2. Recharge the battery.

Battery Charging

WARNING!

Risk of explosion: Do not recharge device in hazardous area.

Failure to follow this warning can result in serious personal injury or death.

WARNING!

- Use of any charger, other than the charger supplied with the device, may damage or improperly charge the batteries.
- The charger is capable of charging a completely depleted pack in less than four hours in normal, room-temperature environments.

Failure to follow these warnings can result in serious personal injury or death.



Allow very hot or cold devices to stabilize for one hour at room temperature before attempting to charge.

To Charge the Device

- Ensure the charger connector is firmly seated in the charge port on the back of the device.
- The battery symbol will scroll through a progressively increasing number of segments and the charge LED will be red until 90 % of full charge has been obtained. Then the battery symbol will remain fully illuminated and the charge LED will be green while the battery is trickle charged to its full capacity.
- If a problem is detected during charging, the battery symbol will flash and the charge LED will be orange. Disconnect the device from the power module and reconnect it to the power module to reset the charge cycle.
- During periods of non-use, the charger may remain connected to the device/battery pack.
- Minimum and maximum ambient temperature to charge the device is 10 °C (50 °F) and 35 °C (95 °F), respectively.
- For best results, charge the device at room temperature 23 °C (73 °F).

3.5 Viewing Additional Pages

The Main Screen appears at device turn-on.

Optional displays can be viewed by pressing the ▼ button to move to:

Bump Mode

1. To select the Bump mode, press the ⏻ button.
2. To move forward, press the ▼ button.
3. To move backward to the Main page, press the ▲ button.

Peak Readings (PEAK page)

The peak icon (→ [3.3 On-Screen Indicators](#)) shows the highest levels of gas recorded by the device since turn-on or since peak readings were reset.

To reset the peak readings:

1. Access the PEAK page.
2. Press the ▲ button.

Minimum Readings (MIN page)

This page shows the lowest level of oxygen recorded by the device since turn-on or since the MIN reading was reset.

The minimum icon (→ [3.3 On-Screen Indicators](#)) appears on the display.

To reset the MIN reading:

1. Access the MIN page.
2. Press the ▲ button.

Short Term Exposure Limits (STEL page)

WARNING!

If the STEL alarm activates, leave the contaminated area immediately; the ambient gas concentration has reached the preset STEL alarm level. Failure to follow this warning will cause over-exposure to toxic gases and persons relying on this product for their safety could sustain serious personal injury or death.

Failure to follow this warning can result in serious personal injury or death.

The STEL icon (→ [3.3 On-Screen Indicators](#)) appears on the display to show the average exposure over a 15 minute period.

When the amount of gas detected by the device is greater than the STEL limit:

- Alarm sounds
- Alarm LEDs flash
- STEL icon flashes.

To reset the STEL:

1. Access the STEL page.
2. Press the ▲ button.

The STEL alarm is calculated over a 15 minute exposure.

STEL calculation examples:

Assume the device has been running for at least 15 minutes:

3 Description

15 minute exposure of 35 ppm:

(15 minutes x 35 ppm)	= 35 ppm
-----------------------	----------

15 minutes

10 minute exposure of 35 ppm and 5 minutes exposure of 5 ppm:

(10 minutes x 35 ppm) + (5 minutes x 5 ppm)	= 25 ppm
---	----------

15 minutes

This page can be de-activated through MSA GALAXY GX2 Test Stand or MSA Link.

Time Weighted Average (TWA page)

WARNING!

If the TWA alarm activates, leave the contaminated area immediately; the ambient gas concentration has reached the preset TWA alarm level. Failure to follow this warning will cause over-exposure to toxic gases and persons relying on this product for their safety could sustain serious personal injury or death.

The TWA icon (→ [3.3 On-Screen Indicators](#)) appears on the display to show the average exposure since the device was turned on or since the TWA reading was reset. When the amount of gas detected is greater than the eight-hour TWA limit:

- Alarm sounds
- Alarm LEDs flash
- TWA icon flashes.

To reset the TWA:

1. Access the TWA page.
2. Press the ▲ button.

The TWA alarm is calculated over an eight-hour exposure.

TWA calculation examples:

1 hour exposure of 50 ppm:

(1 hour x 50 ppm) + (7 hours x 0 ppm)	= 6.25 ppm
---------------------------------------	------------

8 hours

4 hour exposure of 50 ppm and 4 hour exposure of 100 ppm:

(4 hours x 50 ppm) + (4 hours x 100 ppm)	= 75 ppm
--	----------

8 hours

12 hour exposure of 100 ppm:

(12 hours x 100 ppm)	= 150 ppm
----------------------	-----------

8 hours

This page can be deactivated through the MSA GALAXY GX2 Test Stand or MSA Link software.

Time Display

Current time appears on the display in a 12-hour format by default.

A 24-hour format can be selected using MSA GALAXY GX2 Test Stand or MSA Link.

Date Display

Current date appears on the display in the format: **MMM-DD-YYYY**.

Discoverable Mode page

Allows the user to put the device into Bluetooth discoverable mode in order to pair with another device. This page can be deactivated through the BT SETUP page.

Motion Alert Activation

To activate or deactivate the Motion Alert feature, press the ▲ button while the Motion Alert Activation page is displayed. When the Motion Alert feature is active, the Motion Alert symbol (→ [3.3 On-Screen Indicators](#)) will flash every 3 seconds. The device will enter pre-alarm when no motion is detected for 20 seconds. This condition can be cleared by moving the device.

After 30 seconds of inactivity, the full Motion Alert alarm is triggered. This alarm can only be cleared by pressing the ▲ button.

3.6 Sensor Missing Alarm

The device enters the Sensor Missing alarm if the device detects that the sensor is not properly installed in the device or is not functional.

If a sensor is detected as missing, the following occurs:

- "SENSOR ERROR" displays.
- The flag above the sensor detected as missing flashes on the display.
- Alarm sounds and lights flash.
- Yellow Fault LED is on solid.
- If there is a sensor error at startup, the device shuts off in 60 seconds.

3.7 Sensor End of Life Warning

If a sensor is nearing its end of life, the device will warn the user following a sensor calibration. The sensor is still fully functional at this point, but the warning gives the user time to plan for a replacement sensor and minimize downtime. The ♥ symbol will be continuously displayed. For more details, see [4.10 Calibration](#).

3.8 Sensor End of Life Indicator

If the device cannot calibrate one or more sensors, the device will display "SPAN ERR" followed by the Alarm symbol and ♥ symbol to indicate end of sensor life. For more details, see [4.10 Calibration](#).

3.9 Monitoring Toxic Gases

The device can monitor the concentration of the following toxic gases in ambient air:

- Carbon Monoxide (CO)
- Hydrogen Sulfide (H₂S)
- Sulfur Dioxide (SO₂)
- Nitrogen Dioxide (NO₂)

The device displays the gas concentration in parts per million (PPM) or mg/m³ on the Normal Operations page until another page is selected or the device is turned off.

WARNING!

If an alarm activates while using the device, leave the area immediately. Remaining in the area under such circumstances can cause serious personal injury or death.

The device has four gas alarms for each toxic gas:

- HIGH Alarm

3 Description

- LOW Alarm
- STEL Alarm
- TWA Alarm

If the gas concentration reaches or exceeds the alarm set point, the device:

- backlight turns on
- triggers a vibrating alarm
- displays and flashes the Alarm symbol and either the Minimum icon (LOW alarm) or the Maximum (PEAK) icon (HIGH alarm)
- enters an alarm state.



When a gas reading exceeds the full scale range of the sensor, the device displays "+ + +" in place of the actual reading.

When a gas reading falls below a defined under-range threshold, the device displays " - - -" in place of the actual reading.

3.10 Monitoring Oxygen Concentration

The device monitors the oxygen concentration in ambient air. The alarm set points can be set to activate on two different conditions:

- Enriched - oxygen concentration > 20.8% or
- Deficient - oxygen concentration < 19.5%.

While the device can detect up to 30% oxygen in the ambient air, it is approved for use only up to 21% oxygen-content.

WARNING!

If an alarm activates while using the device, leave the area immediately. Remaining in the area under such circumstances can cause serious personal injury or death.

When the alarm set point is reached for either of the above conditions:

- an alarm sounds
- alarm LEDs flash
- a vibrating alarm triggers
- device displays and flashes the Alarm icon and either the Minimum icon (Enriched alarm) or the Maximum icon (Deficient alarm) (→ [3.3 On-Screen Indicators](#)) along with the corresponding oxygen concentration.

The LOW alarm (oxygen deficient) is latching and will not automatically reset when the O₂ concentration rises above the LOW set point. To reset the alarm press the ▲ button. If the alarm condition still exists, the ▲ button only silences the alarm for five seconds.

False oxygen alarms can occur due to changes in barometric pressure (altitude) or extreme changes in ambient temperature.



It is recommended that an oxygen calibration be performed at the temperature and pressure of use. Be sure that the device is in known fresh air before performing a calibration.

When a gas reading exceeds the full scale range of the sensor, the device displays "+ + +" in place of the actual reading.

When a gas reading falls below a defined under-range threshold, the device displays " - - -" in place of the actual reading.

3.11 Monitoring Combustible Gases

The device can monitor these concentrations in ambient air:

- Methane
- Combustible gases

The device displays the combustible gas concentration in % LEL or % CH₄ on the Measuring page until another page is selected or the device is turned off.

WARNING!

If an alarm activates while using the device, leave the area immediately. Remaining in the area under such circumstances can cause serious personal injury or death.

The device has two alarm set points:

- HIGH Alarm
- LOW Alarm

If the gas concentration reaches or exceeds the alarm set point, the device:

- backlight turns on
- a vibrating alarm triggers
- displays and flashes the Alarm symbol and either the Minimum icon (LOW alarm) or the Maximum (PEAK) icon (HIGH alarm)
- enters an alarm state.



When a gas reading reaches 100% LEL or 5.00% CH₄, the device enters a Lock Alarm state: the combustible sensor shuts down and displays "XXX" in place of the actual reading. This state can only be reset by turning the device off and on in a fresh air environment.

When a gas reading falls below a defined under-range threshold, the device displays " - - -" in place of the actual reading.

WARNING!

- A combustible gas reading of "100" or "5" indicates the atmosphere is above 100% LEL or 5.00% vol CH₄ respectively, and an explosion hazard exists. Move away from contaminated area immediately.
- In such cases, the device enters a Lock Alarm state.

Failure to follow this warning can result in serious personal injury or death.



Check your national standard values for 100 % LEL (EN60079-20-1).

4 Operation

Device operation is dialog driven from the display with the aid of the three Function buttons (see [Figure 1 Device overview](#)).

4.1 Environmental Factors

A number of environmental factors may affect the gas sensor readings, including changes in pressure, humidity and temperature. Pressure and humidity changes affect the amount of oxygen actually present in the atmosphere.

Pressure Changes

If pressure changes rapidly (e.g., stepping through airlock), the oxygen sensor reading may temporarily shift and possibly cause the device to go into alarm. While the percentage of oxygen may remain at or near 20.8 Vol %, the total amount of

4 Operation

oxygen present in the atmosphere available for respiration may become a hazard if the overall pressure is reduced by a significant degree.

Humidity Changes

If humidity changes by any significant degree (e.g., going from a dry, air conditioned environment to outdoor, moisture laden air), oxygen readings can be reduced by up to 0.5 %, due to water vapor in the air displacing oxygen.

The oxygen sensor has a special filter to reduce the effects of humidity changes on oxygen readings. This effect will not be noticed immediately, but slowly impacts oxygen readings over several hours.

Temperature Changes

The sensors have built-in temperature compensation. However, if temperature shifts dramatically, the sensor reading may shift. Zero the device at the work site temperature for the least effect.

4.2 Turning ON and Fresh Air Setup

Device operation is dialog driven from the display with the aid of the three Function buttons (see [Figure 1 Device overview](#)).

For more information, see the flow charts in [8 Appendix](#).

1. Turn the device on with the  button.

The device performs a self test and then goes to Fresh Air Setup:

- all display segments are activated
- audible alarm sounds
- alarm LEDs light
- vibrating alarm is activated.

During the self test, the device checks for missing sensors. In the case of a missing sensor, the device displays the Sensor Missing screen and alarms until it is turned off. Otherwise, the turn-on sequence continues.

The device displays:











- Alarm & display self test
- Manufacturer name
- Device name
- Software version
- FCC ID
- IC ID
- Bluetooth software version (if activated)
- Sensor discovery
- Combustible gas type
- Toxic gas units
- Alarm set points (PEAK, MIN) (STEL, TWA)
- Calibration values
- Date and time display
- Last cal date (if activated)
- CAL due date (if activated)
- Fresh Air Setup option.

Screen Displays during Startup



During the startup sequence, all automatic page display timeouts are preset to a range from two to four seconds.

Several sequences and screens occur during start up:

<p>Device Self Test</p> <p>The device performs a self test.</p>	
<p>Device Name and Software version</p> <p>Software version and device name display.</p>	
	
	
	
	
	
	
<p>Combustible Gas Type</p> <p>Name of Combustible Gas Type displays, e.g. BUTANE.</p> <p>NOTE: Combustible gas type can be changed manually through the SENSOR SETUP menu or the MSA GALAXY GX2 Test Stand or MSA Link software.</p>	
<p>Toxic Gas Units</p> <p>Name of Toxic Gas Units displays (ppm or mg/m³).</p> <p>NOTE: Toxic units can only be modified through the MSA GALAXY GX2 Test Stand or MSA Link software.</p>	

4 Operation

Alarm Set points

Alarm set points for all installed and activated sensors display.

LOW alarm set points display, followed by HIGH alarm set points.

NOTE: Alarm set points can be changed manually through the -Setup menu or the MSA GALAXY GX2 Test Stand or MSA Link software.



LOW
ALARMS



COMB/EX O2
10 19.5
CO H2S
25 10



HIGH
ALARMS



COMB/EX O2
20 23.0
CO H2S
100 15

STEL and TWA Set points

The preset STEL and TWA values for installed and activated sensors display.



STEL
CO H2S
100 15



TWA
CO H2S
25 10

Calibration Values

The preset calibration values for installed and activated sensors display.



COMB/EX O2
58 15.0
CO H2S
60 20

Time and Date

The date displays in a month, day and year format.

NOTE: In the event that the battery is fully discharged, the time and date reset. At startup, the user is prompted to enter the time and date.

If the time and date information is missing, they are reset to



(Jan-01-2016) with time stamp (00:00).



TIME
07:31PM



JAN-01
2016

<p>Last CAL Date and CAL Due</p> <p>NOTE: These display options can be set by MSA GALAXY GX2 Test Stand or MSA Link software. If these options are not set, these screens are not displayed.</p> <ul style="list-style-type: none"> • By default, Last Cal is activated. • By default, Cal Due is deactivated. 	
	
<p>Fresh Air Setup (FAS)</p> <p>The FAS screen is prompted.</p>	

4.2.1 Fresh Air Setup (FAS)

The FAS is for automatic Zero calibration of the device.

The Fresh Air Setup has limits. The zero of any sensor that is outside of these limits will not be adjusted by the FAS command.

⚠ WARNING!

Do not activate the Fresh Air Setup unless you are certain you are in fresh, uncontaminated air; otherwise, inaccurate readings can occur which can falsely indicate that a hazardous atmosphere is safe. If you have any doubts as to the quality of the surrounding air, do not use the Fresh Air Setup feature. Do not use the Fresh Air Setup as a substitute for daily calibration checks. The calibration check is required to verify span accuracy. Failure to follow this warning can result in serious personal injury or death.



If a battery charging cycle is interrupted before it is completed (4 hours for a fully discharged battery), allow the device's internal temperature to stabilize for 30 minutes before performing a Fresh Air Setup.



Figure 3 Fresh Air Setup

If this option is enabled, the device displays "FAS?", prompting the user to perform a Fresh Air Setup.

1. Press the ▲ button to bypass the Fresh Air Setup.
 - The Fresh Air Setup is skipped and the device goes to the Measuring page (Main page).
2. Press the ⏻ button within 10 seconds to perform the Fresh Air Setup.
 - The device starts the FAS.
 - The screen shows a No Gas Symbol, a blinking hourglass, and all enabled gas sensor readings.









4 Operation

- At the end of the FAS Calibration, the device displays "FAS PASS" or "FAS ERR" along with the flags of the sensors that were outside of the FAS limits. All sensors that are within the FAS limits will be zeroed.

4.3 Measurement Mode [Normal Operation]

In Normal Operation mode, the user can check the Minimum and Peak readings prior to clearing the STEL and TWA values or performing a Span and Zero Calibration.

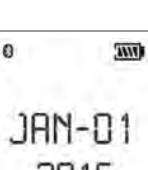
The following options pages can be executed from the Normal Operation screen:

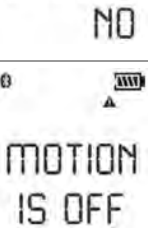
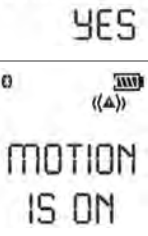
<p>Bump Page</p> <p>This page allows the user to perform a bump test.</p>		
<p>Peak Page</p> <p>This page shows the peak readings for all sensors.</p>		
<p>Min Page</p> <p>This page shows the minimum reading for the oxygen sensor.</p>		
<p>STEL Page</p> <p>This page shows the calculated STEL readings of the device.</p>		
<p>TWA Page</p> <p>This page shows the calculated TWA readings of the device.</p>		
<p>Time / Date Page</p> <p>This page shows actual time and date settings of the device.</p>		
<p>Discoverable Mode</p> <p>This page allows the user to put the device into Bluetooth discoverable mode in order to pair with another device.</p>		
<p>Motion Alert (optional)</p> <p>This page allows the Motion Alert Feature to be -activated or deactivated.</p>		

Using the three device buttons, the user can navigate through each sub-menu in a top/down sequence.

Refer to [Figure 1 Device overview](#) and [8 Appendix](#) for detailed instructions on navigating through these screens.

4.4 Device Setup

The setup menus can be accessed only when the device is turned on while pressing and holding the ▲ button.

This mode can only be activated at device turn-on.

The operation is as follows:

1. Press and hold the ▲ button while turning the device on.
2. Use the ▲ and ▼ buttons to enter the setup password. The default password is "672".
3. Press ⏻ button to enter the setup menus.
 - After two incorrect password entries, device enters Normal Operation mode.
 - Correct password: device continues/beeps once.



The password can be changed through the MSA GALAXY GX2 Test Stand or MSA Link software.

In the Setup mode:

- Press the ⏻ button to store chosen value or go to the next page.
- Press ▲ button to increase values by one or toggle a selection on or off.
- Press and hold ▲ button to increase values by 10.
- Press ▼ button to decrease values by one or toggle a selection on or off.
- Press and hold ▼ button to decrease values by 10.

The following options are available by pressing the ▼ and ▲ buttons:

- Sensor Setup (SENSOR SETUP)
- Calibration Setup (CAL SETUP)
- Alarm Setup (ALARM SETUP)
- Setup Time and Date (TIME DATE)
- Bluetooth Setup (BT SETUP)
- EXIT

4.4.1 Sensor Setup

Each sensor can be turned on or off.

For more information, see the flow charts in [8.6 Sensor Setup](#).



Figure 4 Sensor Setup

1. To bypass this setup, press the ▼ or ▲ button; otherwise, continue as follows.
2. Press the ⏻ button to enter the submenu.
3. Use the ▼ or ▲ button to change the option and confirm with the ⏻ button.
4. Repeat this procedure for all other sensors.
5. After setting the last sensor, continue to Calibration Setup.

4.4.2 Calibration Setup

The user can change and set the calibration values for each sensor.

It is also possible to

- select whether the Cal Due screen is displayed
- set the number of days until the next calibration is due
- select whether the device password screen is displayed to protect Bump and Calibration operations

For more information, see the flow charts in [8.7 Calibrations](#).



Figure 5 Calibration Setup

1. To bypass this setup, press the ▼ or ▲ button; otherwise, continue as follows.
2. Press the ⏻ button to enter the submenu.

The calibration gas concentration of the first sensor is shown.

3. Press the ▼ or ▲ button to change the value.
4. Press the ⏻ button to store the value.

Setup screen for the next sensor is displayed.

5. Repeat the procedure for all other sensors.

After setting the last sensor, the user is prompted to set CALDUE.

6. Press the ▼ or ▲ button to enable or disable CALDUE.
7. Confirm with the ⏻ button.
8. If CALDUE is set on, press the ▼ or ▲ button to select the number of days
9. Confirm with the ⏻ button.
10. Press the ▼ or ▲ button to enable or disable the calibration password (CAL PW) screen.
11. Confirm with the ⏻ button.
12. After confirmation, continue to Alarm setup.

4.4.3 Alarm Setup

The user can switch all alarms on or off and change the alarm set points for each sensor. For more information, see the flow charts in [8.8 Alarm Setup](#).

See [6.1 Factory-set Alarm Thresholds and Setpoints](#) for alarm adjustment limits. The value of the High Alarm can only be set to a value that is higher than the Low Alarm set point.



Figure 6 Alarm Setup

1. To bypass this setup, press the ▼ or ▲ button; otherwise, continue as follows.
2. Press the ⏻ button to enter the submenu.
3. Set alarms on or off by pressing the ▼ or ▲ button.
4. Press the ⏻ button to confirm the selection.

LOW ALARM settings for the first sensor display.

5. Press the ▼ or ▲ button to change the value.
6. Press the ⏻ button to store the value.

HIGH ALARM settings for the first sensor display.

7. Press the ▼ or ▲ button to change the value.
8. Press the ⏻ button to store the value.

STEL ALARM settings (for toxic sensors only) display.

9. Press the ▼ or ▲ button to change the value.
10. Press the ⏻ button to store the value.

TWA ALARM settings (for toxic sensor only) for display.

11. Press the ▼ or ▲ button to change the value.
12. Press the ⏻ button to store the value.
13. Repeat the procedure for all other sensors.
14. After setting the last sensor, continue to Time and Date setup.

60% LEL or 3.0% volume of methane is the maximum High Alarm set point that can be programmed.

The combustible alarm can be turned OFF by the user in the instrument setup. When the combustible alarm is turned OFF, the only indicator to the user that the combustible alarm is turned OFF occurs during power up of the instrument at which a startup screen will indicate that the combustible alarm is turned OFF. When turned ON, the combustible high alarm is latching.

The combustible alarm can be silenced momentarily by pressing the ▲ button. However, if the gas concentration causing the alarm is still present, the device will go back into alarm.

4.4.4 Setup Time and Date

This submenu is for setting date and time.

For more information, see the flow charts in [8.9 Time and Date Setup](#).



Figure 7 Date and Time Setup

1. To bypass this setup, press the ▼ or ▲ button; otherwise, continue as follows.
2. Press the ⏻ button to enter the submenu.
3. Set month by pressing the ▼ or ▲ button.
4. Press the ⏻ button to confirm month.
5. Repeat this procedure for day, year, hours and minutes.

By default, time is displayed in 12 hour format.

The BT SETUP screen will be displayed next.

4.4.5 Enable Bluetooth Operation

The device is configured with a Bluetooth capable communications feature.



1. Press the ▲ button to enable or disable the Bluetooth communications device (ON/OFF).
2. Press the ⏻ button to accept the setting and return to the EXIT? page.

4.5 Bluetooth Operation

NOTE: Versions of this product manufactured July 2022 and later may not contain Bluetooth wireless technology. This will be indicated by the front case of the detector not utilizing a Bluetooth logo. All references in this manual to Bluetooth will not pertain to these version of the device.

The Bluetooth communication device must be enabled for any Bluetooth functions to operate. See [4.4 Device Setup](#). Compatible Bluetooth host with appropriate software is required for proper operation.

Bluetooth Security

The Bluetooth connection is encrypted and secured with a unique six digit pin that must be double confirmed on both device and Bluetooth host at the time of pairing.

Discovery Mode

This device mode is used to enable a Bluetooth host to pair with the device for the first time or if a different Bluetooth host was connected with the device previously.



Note that the device will automatically enter discovery mode for five minutes at device turn on if Bluetooth has been enabled. Discovery mode will also be entered for 5 minutes following a disconnection.

To manually enter Discovery Mode:

1. Page down through the menu pages in Normal Operation mode using the ▼ button until the Discovery Mode page is displayed.
2. Press the ▲ button until the display shows dSCVRY YES.
3. Press the ⏻ button to enter Discovery Mode.

The blue LED will blink rapidly indicating that the device is in Discovery Mode.

Connecting the Device to a Bluetooth Host for the First Time

1. Ensure that the device is on and in Discovery Mode
2. On the Bluetooth host, locate the Bluetooth device list. Select "A4X-xxxxxxx" from the list.

Both the device and Bluetooth host will display a unique six digit security code to ensure that the correct devices are being paired.

3. After verifying that the six digit codes match, confirm the pairing request on the device by pressing the ▼ button.
4. Confirm on the Bluetooth host as well.

Bump Pairing the Device to a Bluetooth Host

This device has an integrated RFID chip to facilitate a faster Bluetooth pairing process with a Bluetooth host that supports a RFID or NFC reader with appropriate software. Simply align the RFID or NFC reader of the Bluetooth host directly over the approval label on the back of the device. The device and Bluetooth host should become paired and connected.

Connecting the Device to a Bluetooth Host

If this was the last device connected to the Bluetooth host, the Bluetooth host can connect to the device whether or not the device is in discovery mode as long as Bluetooth is enabled. The six digit code confirmation will not be displayed.



The device will only recall the last Bluetooth host it was paired with. If connecting to another Bluetooth host, the device must be placed into discovery mode to be detected.

Disconnecting the Device from a Bluetooth Host

The device does not have a disconnect feature as this would be initiated by the Bluetooth host. Use the Bluetooth host functions to purposefully disconnect the device from the Bluetooth host.

Device Configuration over Bluetooth Connection

The device has the ability to receive updates to device settings over the Bluetooth connection. The user must successfully pair the device and Bluetooth host confirming that the six digit security code matches both on the device and the Bluetooth host. After a configuration change has been initiated, the user must confirm the request on the device by pressing the ▼ button.

Evacuation Alert over Bluetooth Connection

The device has the ability to receive an evacuate message over the Bluetooth connection. The user must successfully pair the device and Bluetooth host confirming that the six digit security code matches both on the device and the Bluetooth host. Once connected, an evacuate message sent to the device will send the device into alarm while displaying EVAC on the display. Press the ▲ button to silence the Evacuation alert and confirm the alert was received. Press the ▲ button a second time to reset the Evacuation alert once in a safe area.

4 Operation

4.6 Data Logging

This device's data logs can be downloaded via the GALAXY GX2 Automated Test Stand or via a PC using MSA Link software.

Connecting device to PC

1. Switch ON the device and align the Datalink Communication port on the device to the IR interface of the PC.
2. Start the MSA Link software on the PC and start the connection by clicking the connect icon.

4.7 Function Tests

Alarm Test

Turn on the device. Verify that:

- all LCD segments are activated momentarily
- alarm LEDs flash
- horn sounds briefly
- vibrating alarm triggers briefly.

4.8 Bump Test

WARNING!

Perform a Bump Test before each day's use to verify proper device operation.

Failure to perform this test can result in serious personal injury or death.



Bump test frequency is often stipulated by national or corporate regulations; however, bump testing before each day's use is generally the accepted best safety practice and is therefore MSA's recommendation.

This test quickly confirms that the gas sensors are functioning. Perform a full calibration periodically to ensure accuracy and immediately if the device fails the Bump Test. The Bump Test can be performed using the procedure below or automatically using the GALAXY GX2 Test Stand.

CSA requires (per 22.2 NO. 152) that combustible sensor sensitivity be tested before each day's use on a known concentration of methane equivalent to 25 to 50 % of full scale concentration. ACCURACY MUST BE WITHIN 0 to +20 % OF ACTUAL. Correct accuracy by performing the calibration procedure described in [4.10 Calibration](#).

Equipment

See accessory section for ordering information for these components.

- Calibration Check Gas Cylinder
- 0.25 liters/min. Flow Regulator
- 1/8" ID Superthane Ester Tubing
- Calibration Cap

Performing a Bump Test

1. Connect the regulator to the Calibration Check Gas Cylinder.
2. From the Normal Operation screen press the ▼ button to display "BUMP TEST?".
3. Verify the gas concentrations displayed match the Calibration



Check Gas Cylinder. If they do not, adjust the values through the Calibration Setup menu as described in [4.4 Device Setup](#).

4. Attach the calibration cap (see [4.10.2 Attach the Calibration Cap](#))

5. Press the  button to start the Bump Test. If calibration lockout option is selected, enter password. The hourglass will flash and the sensors will respond to the gas.



6. Open the pressure reducer valve on test gas cylinder.
7. Close the valve after bump testing.

After the Bump Test completes, the device momentarily displays “BUMP PASS” or “BUMP ERROR” along with the label of any sensor that failed before returning to Normal Operation mode. If the device fails the Bump Test, perform a calibration as described in [4.10.2 Attach the Calibration Cap](#).

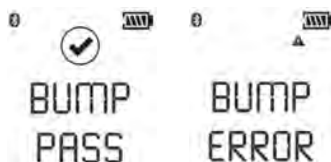

The  symbol will be displayed in the Normal Operation mode and the Bump LED will flash green for 24 hours after a successful Bump Test.

4.9 Bump LED

The device is equipped with a green Bump LED. The green LED flashes every 15 seconds under the following conditions:

- the Bump LED feature is enabled
- after a successful Bump Test (for 24 hours)
- device is in Normal Operation mode
- device is not in Low Battery warning or alarm

4.10 Calibration

The device can be calibrated either manually using this procedure or automatically using the GALAXY GX2 Test Stand. Refer to [8.7 Calibrations](#).

Calibration must be performed using a flow regulator with a flow rate set to 0.25 liters per minute.

If a battery charging cycle is interrupted before it is completed (4 hours for a fully discharged battery), allow the device's internal temperature to stabilize for 30 minutes before performing a Calibration.

NOTE: The GALAXY GX2 Test Stand is not a CSA certified calibration method.



Under normal circumstances MSA recommends calibration at least every six months, however, many European countries have their own guidelines. Please check your national legislation.

4.10.1 Fresh Air Setup and Zero Calibration



To skip the Zero procedure and move directly to the Calibration Span procedure, push the ▲ button. If no button is pushed for 30 seconds, the device prompts user to perform a Span calibration before returning to the Normal Operation mode.

1. Press and hold the ▲ button in Normal Operation mode for three seconds.
2. If calibration lockout option is selected, enter password.

ZERO CAL? screen is then displayed.

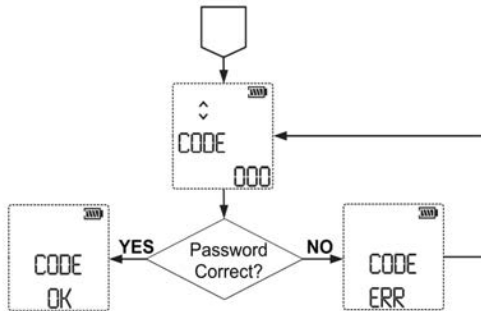

- If calibration lockout option is NOT selected:

ZERO screen displays.



3. With the device exposed to fresh air, press the ⏻ button to confirm the *ZERO CAL?* screen. A sensor refresh and Zero Calibration will occur.



Alternatively press the ▼ button to execute a Fresh Air setup (FAS). See [4.2 Turning ON and Fresh Air Setup](#) for more details.

After Zero calibration completes, the device momentarily displays “ZERO PASS” or “ZERO ERR” along with the flag of any sensor that failed.



During zero calibration the O₂ sensor is also span calibrated to 20.8% O₂ fresh air, adjusting the calibration curve as needed. During span calibration, the O₂ sensor's accuracy is checked against a known oxygen gas concentration without adjusting the calibration curve.

4.10.2 Attach the Calibration Cap

Attach the calibration cap to the device:

1. Insert tab on calibration cap into slot on device.
2. Press calibration cap as shown until it seats onto device.



3. Press both side tabs down onto device until they snap into place.
4. Ensure that the calibration cap is properly seated.
5. Connect one end of the tubing to the calibration cap.

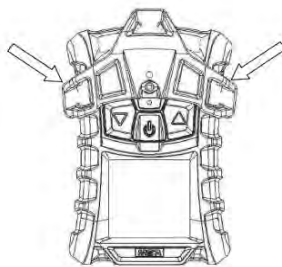

6. Connect other end of tubing to the cylinder regulator (supplied in the calibration kit).

4.10.3 Span Calibration



To skip the Span procedure, push the ▲ button.

If no button is pushed for 30 seconds, the device returns to Normal Operation mode.

1. Once the Zero is set, the SPAN CAL? screen displays.
2. Connect the regulator to the calibration check gas cylinder.
3. Connect the appropriate calibration gas to the device.
4. Attach the calibration cap (see [4.10.2 Attach the Calibration Cap](#))
5. Open the pressure reducer valve on test gas cylinder.
6. Press the  button to calibrate (span) the device.



- SPAN calibration starts.*
7. Close the valve after SPAN calibration.



- After the SPAN calibration completes, the device momentarily displays "SPAN PASS" or "SPAN ERR" along with the label of any sensor that failed then returns to Normal Operation mode.



If a sensor is nearing its end of life, this "SPAN PASS" indication will be followed by the end of sensor life warning (♥ symbol). The ♥ symbol, and the gas type of the sensor nearing its end of life, will blink for 15 seconds when the device returns to Normal Operation mode. When in Normal Operation mode, the ♥ symbol is continuously displayed.

Finishing Calibration

5 Maintenance

1. Close the valve on the regulator.
2. Remove the calibration cap.

The calibration procedure adjusts the span value for any sensor that passes the ca-libration test; sensors that fail calibration are left unchanged. Since residual gas may be present, the device may briefly go into an exposure alarm after the ca-libration sequence is completed.

Autocalibration Failure

If the span calibration is unsuccessful:

- If the device cannot calibrate one or more sensor(s), it goes to the SPAN ERR page and remains in alarm until the ▲ button is pressed.
- A sensor life indicator is displayed (Alarm symbol and ♥ symbol) to show the sensor has reached its end of life and should be replaced.

This occurs if the span calibration is unsuccessful twice.

- The device will remain in alarm state until the ▲ button is pressed.
- The Alarm symbol and ♥ symbol will remain on the display until a successful calibration or sensor in question is replaced.



A span calibration can fail for many reasons besides sensor at the end of his life. If a span calibration failure occurs, items such as remaining gas in the calibration cylinder, gas expiration date, security of the calibration cap, etc. should be verified and calibration should be repeated prior to replacing the sensor.

4.11 Time of Day Testing

This feature permits the device to be automatically calibrated on a user-defined interval. The most common use of this feature allows the user to configure the ALTAIR 4XR and the GALAXY GX2 System to automatically calibrate a device prior to the start of work-shift. See the GALAXY GX2 Operating Manual ("Automated Testing Features" section) for a complete description of how to configure the GALAXY GX2 for this mode.

On ALTAIR 4XR devices, the following settings must be configured using either MSA Link software or the GALAXY GX2 → Instrument Setup page:

- For automated calibration testing, Calibration Due must be enabled and a non-zero Calibration Interval must be entered for automatic calibration testing.
- For automated bump testing, Bump Due must be enabled and a non-zero Bump Interval must be entered for automatic bump testing.

Carefully follow all GALAXY GX2 set-up directions as described in the GALAXY GX2 Operating Manual for proper setup.

5 Maintenance

If an error occurs during operation, use the displayed error codes to determine appropriate next steps. The device should be regularly checked and maintained by qualified personnel.

WARNING!





- Repair or alteration of the device beyond the procedures described in this manual by anyone other than a person authorized by MSA, could cause the unit to fail to perform properly. Use only genuine MSA replacement parts when performing any maintenance procedures described in this manual.
- Substitution of components can seriously impair performance of the unit, alter intrinsic safety characteristics or void agency approvals.

Failure to follow these warnings can result in serious personal injury or death.

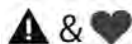

Refer to EN 60079-29-2 (Guide for the selection, installation, use and maintenance of apparatus for the detection and measurement of combustible gases or oxygen) and EN 45544-4 (Guide for the selection, installation, use and maintenance of electrical apparatus used for the direct detection and direct concentration measurement of toxic gases and vapors).

5.1 Troubleshooting

Problem	Description	Reaction
ERROR TEMP	Temperature is below -40°C (-40 °F) or above 75°C (167 °F).	Return device to normal temperature range and recalibrate. Contact MSA
ERROR EE	EEPROM Memory error	Contact MSA
ERROR PRG	Flash Memory error	Contact MSA
ERROR RAM	RAM Memory error	Contact MSA
ERROR BT	Bluetooth error	Contact MSA
ERROR UNK	Unknown error	Contact MSA
 LOW BATT	Battery warning repeats every 60 seconds.	Remove from service as soon as possible and recharge battery
 BATT ALARM	Battery is completely discharged.	Device is no longer sensing gas. Remove from service and recharge battery.
ERROR CHARGE	Charge error	Device must be between 10° C and 36° C to charge. Contact MSA if problem persists
SENSOR ERROR	Missing Sensor	Verify if sensor is properly -installed
Device does not turn on	Low battery	Charge device
 *	Sensor Warning	Sensor is near the end of its life
	Sensor Alarm	Sensor has reached the end of its life and cannot be calibrated. Replace sensor and recalibrate.
or		
 (flashing)*		

*Sensor Warning and Sensor Alarm indicate that the device detects a loss of sensor sensitivity during calibration. In addition to true loss of sensor sensitivity, the device may issue a Sensor Warning or Sensor Alarm if calibration gas is expired, misapplied or not used during the span calibration. Ensure the quality of the calibration gas and the calibration gas delivery system. Recalibration may remove the Sensor Warning or Sensor Alarm indication.

5.2 Live Maintenance Procedure - Replacing and Adding a Sensor

WARNING!

Remove and reinstall sensors carefully, ensuring that the components are not damaged; otherwise device intrinsic safety may be adversely affected, wrong readings could occur, and persons relying on this product for their safety could sustain serious personal injury or death.

WARNING!

Before handling the PC board, ensure you are properly grounded; otherwise, static charges from your body could damage the electronics. Such damage is not covered by the warranty. Grounding straps and kits are available from electronics

suppliers.

Failure to follow this warning can result in serious personal injury or death.

To add a sensor to an device that is not already equipped with a full array of sensors, remove the sensor plug from in front of the formerly unused sensor housing.



While device case is open, do not touch any internal components with metallic/conductive objects or tools. Damage to the device can occur.

1. Verify that the device is turned off.
2. Remove the four case screws, and remove the case front while carefully noting the orientation of the sensor gasket.
3. Gently lift out and properly discard the sensor to be replaced.
 - a. Using fingers only, gently remove the toxic, combustible, or oxygen sensor by gently rocking it while pulling it straight from its socket.
4. Carefully align the new sensor contact pins with the sockets on the printed circuit board and pressing it firmly in place.
 - a. Ensure tab on sensor aligns with groove at top of holder.
 - b. Insert the toxic sensor by placing it in the left-hand position of the sensor holder.
 - c. Insert the O₂ sensor by placing it in the right-hand position of the sensor holder.
 - d. Insert the combustible sensor by placing it in the middle position of the sensor holder.
 - e. If any sensor is not to be installed, ensure that a sensor plug is installed properly in its place.
5. Reinstall the case front.
6. Reinstall the screws.
 - a. Tighten each screw with a torque value of 6.00 in-lbs (+/- 0.25 in-lbs) or 0.678 Nm (+/- 0.028 Nm) to maintain the device's IP 68 rating.
7. Turn on the device.

If the sensor replaced is the same as the previous sensor:

- The device starts up normally.
- The device automatically senses that a new sensor is installed and displays the "SENSOR DSCVRY" screen.

If the sensor replaced is not the same as the previous sensor or this sensor channel was deactivated:

- The device automatically senses the difference and displays "SENSOR CHANGE".
- "ACCEPT?" appears on the display.
 - Accept the change with ▼ button or reject with ▲ button.
 - Go into the sensor setup and turn on the appropriate sensor (→ [4.4.1 Sensor Setup](#)).

8. Calibrate the device after the sensors have stabilized.

⚠ WARNING!

Calibration is required after a sensor is installed; otherwise, the device will not perform as expected and persons relying on this product for their safety could sustain serious personal injury or death.



Allow sensors to stabilize at room temperature for at least 30 minutes before calibration (→ [4.10 Calibration](#)).

5.3 Cleaning

- **Routine Cleaning:** Clean the exterior of the device regularly using only a damp cloth. Do not use cleaning agents, as many contain silicone, which will damage the combustible sensor.
- **Dust and Dirt Exposure:** Use a dry, soft bristled brush to remove any dust or dirt that has accumulated on the apparatus, especially at the sensor openings. If there is a buildup of dust or dirt particles remaining in the sensor area after brushing, use a vacuum to remove remaining particles, but maintain at least a 1/2 inch (1.3 cm) distance from the gas detector.
- **Water Exposure:** If the apparatus is exposed to water, turn the device sensor side down and gently shake water off the sensor area. Any remaining water can be removed with a clean dry cloth.

5.4 Storage

When not in use, store the device in a safe, dry place between 18 °C (64 °F) and 30 °C (86 °F). After storage, always recheck device calibration before use.

5.5 Scope of Delivery

Pack the device in its original shipping container with suitable padding. If the original container is unavailable, an equivalent container may be substituted.

6 Technical Data

Weight	7.9 oz./224 g (device with battery and clip)
Dimensions (L x W x H)	4.4 x 3.00 x 1.37 inches/112 x 76 x 33 mm – without fastening clip
Alarms	Four gas alarm LEDs, a charge status LED, an audible alarm and a vibrating alarm
Volume of audible alarm	95 dBA at 30 cm typical
Display	LCD display
Battery type	Rechargeable Li polymer battery. Must not be charged in Ex area.
Device run time (Bluetooth OFF)	24 hours at 25 °C (77 °F)
Charging time	≤ 4 hours The maximum safe area charging voltage $U_m = 6.7$ VDC
Warm up time	2 min
Temperature range	14 to 104 °F (-10 to 40 °C) Normal operating range -40 to 140 °F (-40 to 60 °C) Extended operating range 50 to 95 °F (10 to 35 °C) While charging battery -40 to +140 °F (-40 to 60 °C) Intrinsic safety ambient temperature range (ATEX, IEC) -40 to +129 °F (-40 to 54 °C) Intrinsic safety ambient temperature range (CSA, ETL)
Humidity range	15 % – 90 % relative humidity, non-condensing, 5 % – 95 % RH intermittent
Atmospheric pressure range	800 to 1200 mbar
Ingress protection	IP 68 (2 meters for 45 minutes)
Measuring methods	Combustible gases: Catalytic sensor Oxygen: Electrochemical sensor Toxic gases: Electrochemical sensor

	Combustible	O₂*	CO	H₂S
Measuring range	0-100% LEL	0-30% Vol.	0-1999 ppm	0-200 ppm
	0-5.00% Vol.CH ₄		0-1999 mg/m ³	0-284 mg/m ³
	H₂S-LC	NO₂	CO-H₂	SO₂
	0-100 ppm	0-50 ppm	0-1999 ppm	0-20 ppm

* Certified for 0 - 25 vol.% O₂

The technical and performance specifications for the specialized EX-H and EX-M sensor are the same as for the standard EX sensor.



The ppm to mg/m³ conversion is calculated at 20° C (68 °F) and at atmospheric pressure.

6.1 Factory-set Alarm Thresholds and Setpoints



Check the monitor or calibration certificate for exact alarm levels as they vary depending on national or corporate regulations.

Sensor	LOW alarm	HIGH alarm	STEL	TWA
EX (% LEL)	10	20	--	--
EX-H (% LEL)	10	20	--	--
EX-M (% vol)	0.5	1.0	--	--
O ₂ (% vol)	19.5	23.0	--	--
H ₂ S (ppm)	10	15	15	10
H ₂ S-LC(ppm)	5	10	10	1
CO (ppm)	25	100	100	25
NO ₂ (ppm)	2	5	5	2
SO ₂ (ppm)	2	5	5	2

Sensor	Min. alarm set point	Max. alarm set point
EX (% LEL)	5	60
EX-H (% LEL)	5	60
EX-M (% vol)	0.1	3.0
O ₂ (% vol)	5	24
H ₂ S (ppm)	5	175
H ₂ S-LC (ppm)	1	70
CO (ppm)	10	1700
NO ₂ (ppm)	.5	47.5
SO ₂ (ppm)	.5	17.5

Sensor	Default Calibration Setpoint	Min. Calibration Setpoint	Max. Calibration Setpoint
EX (% LEL)	58	5	100
EX-H (% LEL)	58	5	100
EX-M (% vol)	2.5	0.1	5.0
O ₂ (% vol)	15.0	5.0	30.0
H ₂ S (ppm)	20	5	200
H ₂ S-LC (ppm)	20	1	70
CO (ppm)	60	10	1700
NO ₂ (ppm)	10	1	50
SO ₂ (ppm)	10	1	20

6 Technical Data

Feature	Options
Instrument password	000 - 999
Cal Due days	1 - 180
Combustible gas type	Methane, butane, propane, pentane, nonane, hydrogen, combustible
Gas measurement units <ul style="list-style-type: none"> • Combustible sensor • Toxic sensor 	<ul style="list-style-type: none"> • % LEL or % CH₄ • ppm or mg/m³
Periodic log collection rate	Off, 15 sec, 30 sec, 1 min, 3 min, 5 min, 10 min, 15 min
Backlight timeout	Off, 10 sec, 30 sec, 1 min, 3 min, 5 min, 10 min, On

6.2 Performance Specification

Combustible Gas

Range	0 to 100 % LEL or 0 to 5 % CH ₄
Resolution	1 % LEL or 0.05 % vol CH ₄
Reproducibility	3 % LEL, 0 % to 50 % LEL reading or 0.15 % CH ₄ , 0.00 % to 2.50 % CH ₄ (normal temperature range)
	5 % LEL, 50 % to 100 % LEL reading or 0.25 % CH ₄ , 2.50 % to 5.00 % CH ₄ (normal temperature range)
	5 % LEL, 0 % to 50 % LEL reading or 0.25 % CH ₄ , 0.00 % to 2.50 % CH ₄ (extended temperature range)
	8 % LEL, 50 % to 100 % LEL reading or 0.4 % CH ₄ , 2.50 % to 5.00 % CH ₄ (extended temperature range)
Response time	90 % of final reading in less than or equal to 15 sec (Pentane) and 10 sec (methane) (normal temperature range)

Combustible Gas Cross Reference Factors for General Purpose Calibration Using Calibration Cylinder (P/N 10053022)

Combustible Gas	Methane Calibration 1.45 Vol % CH ₄ Set 33 % LEL	Pentane Simulant Calibration 1.45 Vol % CH ₄ Set 58 % LEL
Acetone*	1.09	0.62
Acetylene	1.07	0.61
Butane	1.37	0.79
Cyclohexane	1.94	1.11
Diethylether*	1.43	0.82
Ethane	1.27	0.73
Ethanol*	1.16	0.66
Ethylene	1.09	0.62
Gasoline	1.63	0.93
n-Hexane	1.86	1.06
Hydrogen	0.98	0.56
Isobutane	1.63	0.93
Isopropyl Alcohol*	1.55	0.88

Combustible Gas	Methane Calibration 1.45 Vol % CH ₄ Set 33 % LEL	Pentane Simulant Calibration 1.45 Vol % CH ₄ Set 58 % LEL
Methane	1.00	0.57
Methanol*	0.93	0.53
Nonane*	4.48	2.56
Nonane with EX-H sensor	3.03	1.73
Pentane	1.90	1.00
Propane	1.39	0.79
Propylene	1.14	0.65
Toluene*	2.09	1.19
Xylene*	4.83	2.76
Xylene with EX-H sensor	3.57	2.04

NOTE: Gas in the table above indicated with a * will have significantly longer response times, especially at lower concentration levels.

Response notes

1. Some compounds may reduce the sensitivity of the combustible gas sensor by poisoning or inhibiting the catalytic action or by polymerizing on the catalytic surface.
2. Multiply the displayed % LEL value by the conversion factor above to get the true % LEL.
3. These conversion factors should be used only if the combustible gas is known.
4. All factors are based on the IEC 100 % LEL levels
 - a. i.e. Methane 100% LEL = 4.4 Vol %,
 - b. Pentane 100% LEL = 1.1 Vol %
 - c. Propane 100% LEL = 1.7 Vol %
5. These conversion factors are typical. Individual units may vary by $\pm 25\%$ from these values.
6. The results are intended for guidance only. For the most accurate measurements, a device should be calibrated using the gas under investigation.
7. The conversion factors for the standard EX and the specialized EX-H and EX-M sensor are the same except for EX-H and Nonane and o-Xylene. The conversion factors for these two vapors are therefore especially mentioned in the table.

Oxygen

The oxygen sensor has built-in temperature compensation. However, if temperature shifts dramatically, the oxygen sensor reading may shift. Zero the device at a temperature within 30 °C (86 °F) of the work place temperature for the least effect.

Range	0 to 30 vol.% O ₂ *
Resolution	0.1 vol.% O ₂
Reproducibility	0.7 vol.% O ₂ for 0 to 30 vol.% O ₂
Response time (90% of final reading)	90 % of final reading, 16 seconds typical (normal temperature range)
Sensor Cross-Sensitivity	The oxygen sensor has no common cross-sensitivities.

* Certified for 0 - 25 vol.% O₂

Carbon Monoxide



Data is presented as the indicated output in PPM which will result from the application of the test gas.

6 Technical Data

Range	0 - 1999 ppm (0 - 1999 mg/m ³) CO
Resolution	1 ppm (1.2 mg/m ³) CO for 0 to 1999 ppm
Reproducibility	±5 ppm (5.8 mg/m ³) CO or 10 % of reading, whichever is greater (normal temperature range)
	±10 ppm (11.6 mg/m ³) CO or 20 % of reading, whichever is greater
Response time	90% of final reading in less than or equal to 15 seconds (normal temperature range)

Test Gas Applied	Concentration (PPM) Applied	CO Channel % Cross-sensitivity
Hydrogen Sulfide (H ₂ S)	40	0
Carbon Monoxide (CO)	100	100
Nitric Oxide (NO)	50	84
Nitrogen Dioxide (NO ₂)	11	0
Sulfur Dioxide (SO ₂)	9	-4
Chlorine (Cl ₂)	10	0
Hydrogen Cyanide (HCN)	30	-5
Ammonia (NH ₃)	25	0
Toluene	53	0
Isopropanol	100	-8
Hydrogen (H ₂)	100	48

Hydrogen Sulphide

Range	0 - 200 ppm (0 to 284 mg/m ³) H ₂ S
Resolution	1 ppm (1.4 mg/m ³) H ₂ S, for 3 to 200 ppm (4,3 to 284 mg/m ³) H ₂ S
Reproducibility	±2 ppm (2.8 mg/m ³) H ₂ S or 10 % of reading, whichever is greater (normal temperature range) 0 to 100 ppm (0 to 142 mg/m ³) H ₂ S,
	±5 ppm (7,1 mg/m ³) H ₂ S or 10 % of reading, whichever is greater
Response time	90 % of final reading in less than or equal to 15 seconds (normal temperature range)

Test Gas Applied	Concentration (PPM) Applied	H ₂ S Channel % Cross-sensitivity
Hydrogen Sulfide (H ₂ S)	40	100
Carbon Monoxide (CO)	100	1
Nitric Oxide (NO)	50	25
Nitrogen Dioxide (NO ₂)	11	-1
Sulfur Dioxide (SO ₂)	9	14
Chlorine (Cl ₂)	10	-14
Hydrogen Cyanide (HCN)	30	-3
Ammonia (NH ₃)	25	-1

Test Gas Applied	Concentration (PPM) Applied	H ₂ S Channel % Cross-sensitivity
Toluene	53	0
Isopropanol	100	-3
Hydrogen (H ₂)	100	0

Hydrogen Sulphide Low Concentration (H₂S-LC)

Range	0 - 100 ppm H ₂ S
Resolution	0.1 ppm H ₂ S
Reproducibility	±0.2 ppm H ₂ S or 10 % of reading, whichever is greater (normal temperature range)
	±0.5 ppm H ₂ S or 20 % of reading, whichever is greater (extended temperature range)
Response time (typical)	90% of final reading < 15 seconds (normal temperature range)

Nitrogen Dioxide

Range	0 - 50 ppm NO ₂
Resolution	0.1 ppm NO ₂
Reproducibility	±1 ppm NO ₂ or 10 % of reading, whichever is greater (normal temperature range)
	±2 ppm NO ₂ or 20 % of reading, whichever is greater (extended temperature range)
Response time (typical)	90 % of final reading < 20 seconds (normal temperature range)

Sulfur Dioxide

Range	0 - 20 ppm SO ₂
Resolution	0.1 ppm SO ₂
Reproducibility	±1 ppm SO ₂ or 10 % of reading, whichever is greater (normal temperature range)
	±2 ppm SO ₂ or 20 % of reading, whichever is greater (extended temperature range)
Response time (typical)	90 % of final reading < 20 seconds (normal temperature range)

Hydrogen Resistant CO (CO-H₂-RES)

Range	0 - 2000 ppm CO
Resolution	1 ppm CO
Reproducibility	±5 ppm CO or 10 % of reading, whichever is greater (normal temperature range)
	±10 ppm CO or 20 % of reading, whichever is greater (extended temperature range)
Response time (typical)	90% of final reading < 20 seconds (normal temperature range)
Hydrogen resistance	< 5 %

6.3 XCell Sensor Patents

- US 8826721
- US 7959777

6 Technical Data

- US 8702935
- US 8790501
- Additional patents pending

7 Ordering Information

Description	Part Number
Sensor Replacement Kits	
EX	10106722
EX-H	10121211
EX-M	10121212
O2	10106729
CO/H2S	10106725
CO/H2S-LC	10121213
CO-H2/H2S	10121214
CO/NO2	10121217
SO2/H2S-LC	10121215
Repair Kits	
Front Housing with dust filters	
• Charcoal	
○ with Bluetooth	10178360
○ without Bluetooth	10236170
• Phosphorescent	
○ with Bluetooth	10178361
○ without Bluetooth	10236169
LCD assembly	10179265
Stainless steel suspender clip, screws, & sensor gasket	10110062
Stainless steel suspender clip kit	10208107
Replacement Belt Clip Screw, Package of 50	10193731
Power Supplies	
Power Supply with Charge Connector	
• North America	10092233
• Global	10092936
Charging cradle with power supply	
• North America	10087368
• Europe	10086638
• Australia	10089487
Vehicle charging cradle	10095774
Calibration	
Pressure reducer valve 0.25 l/min	467895
Calibration assembly (cap, tube, connector)	10089321
Calibration Cylinder 58L 4-gas mix (1.45% CH ₄ , 15% O ₂ , 60 ppm CO, 20 ppm H ₂ S)	
• North America	10045035
• Europe	10053022

7 Ordering Information

Description	Part Number
Accessories	
ALTAIR Pump Probe	
• North America	10152669
• ATEX/IEC	10152668
• China	10150031
JetEye IR adapter with USB connector	10082834



GALAXY GX2 and additional accessories are available on request.

8 Appendix

8.1 Start Up Sequence (Power on)

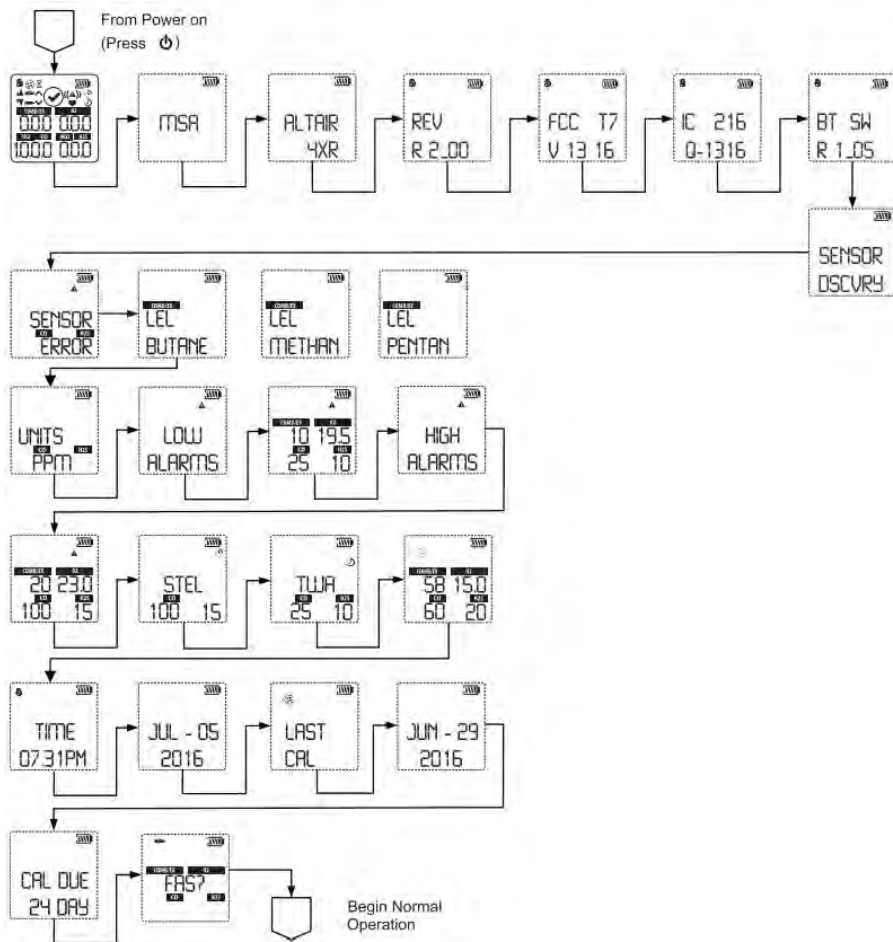

8.2 Fresh Air Setup (FAS)

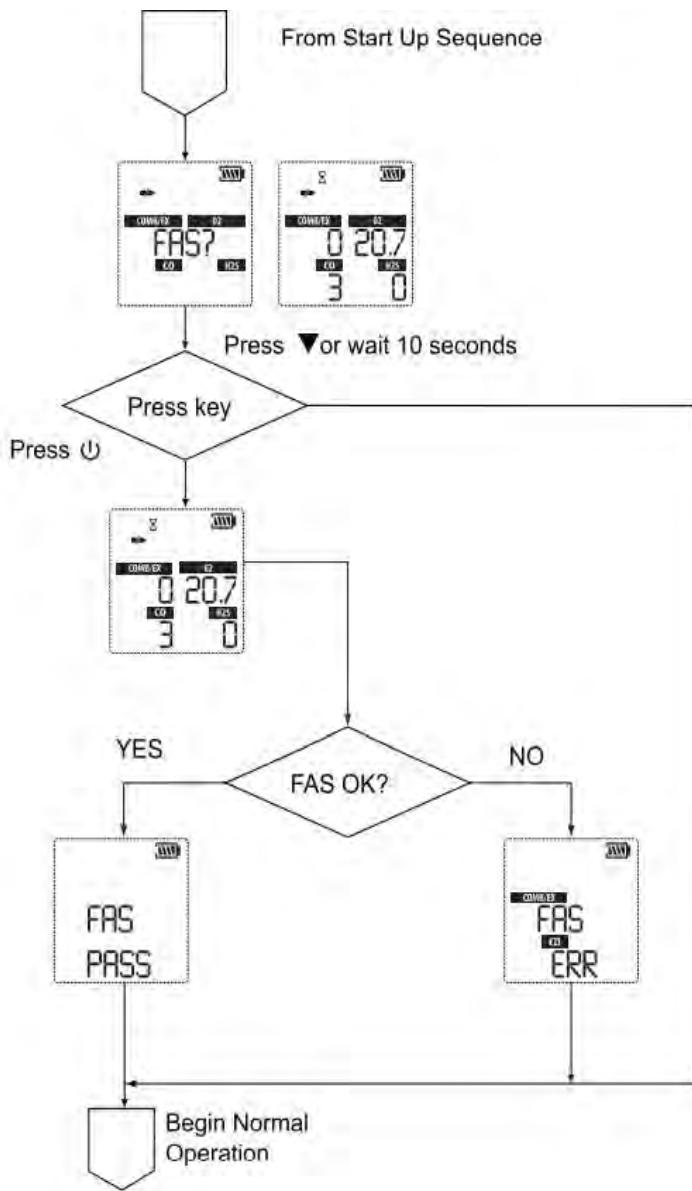

8.3 Reset Screen Controls

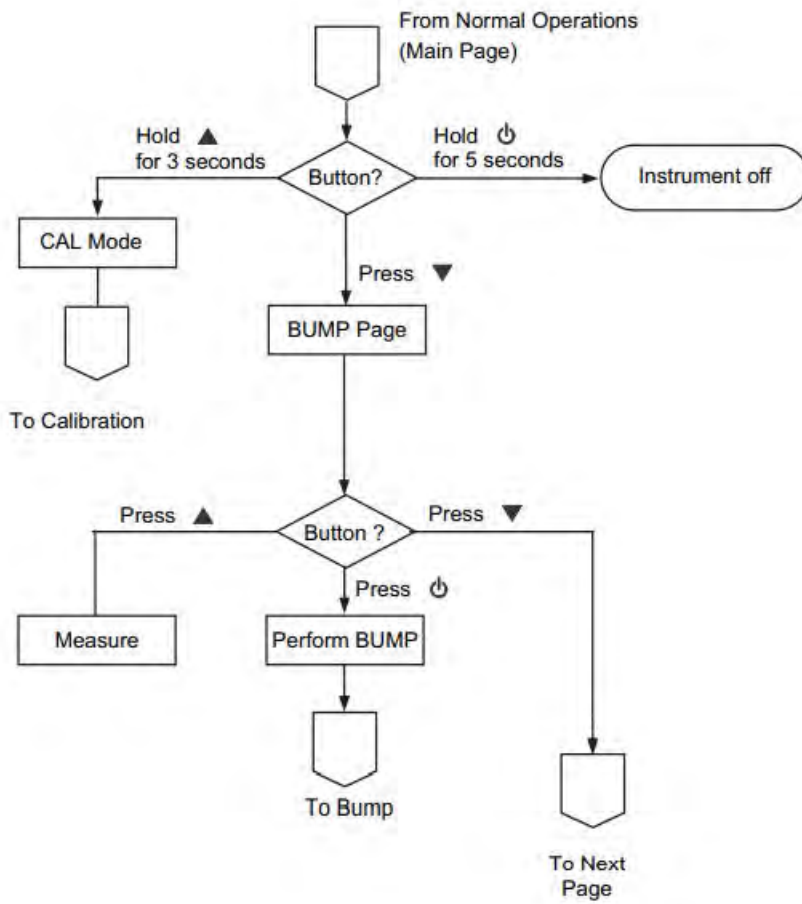

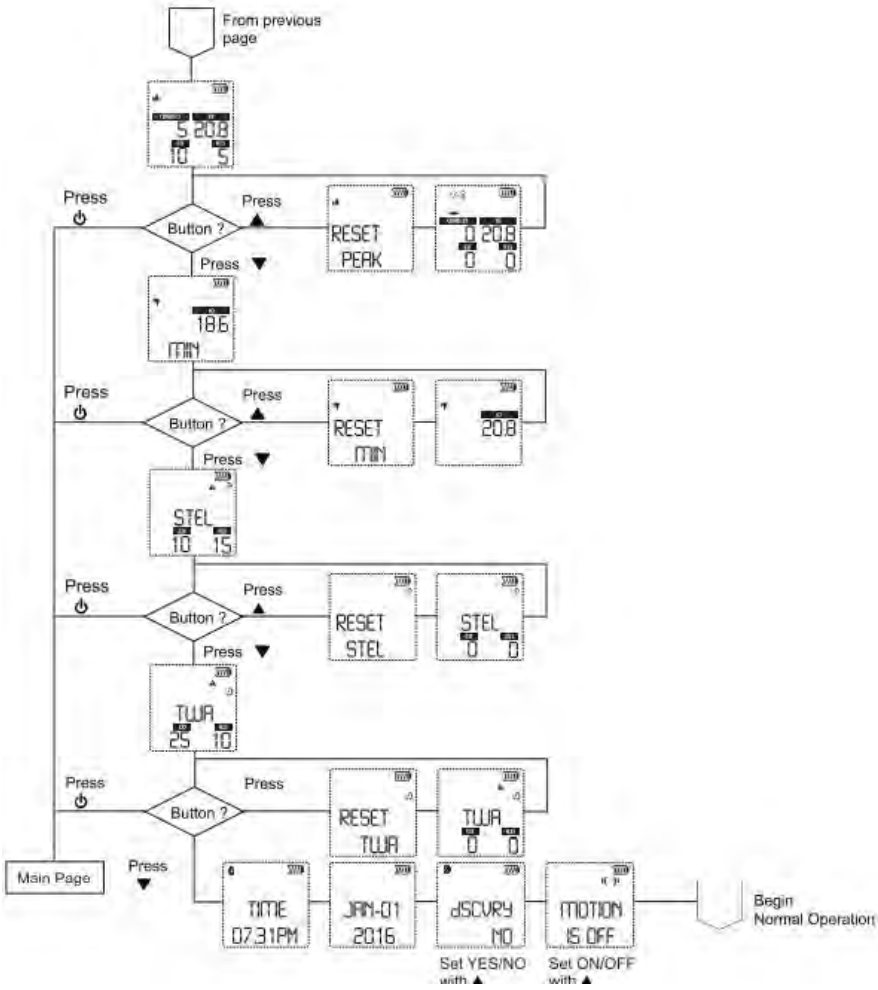

8.4 Bump Test

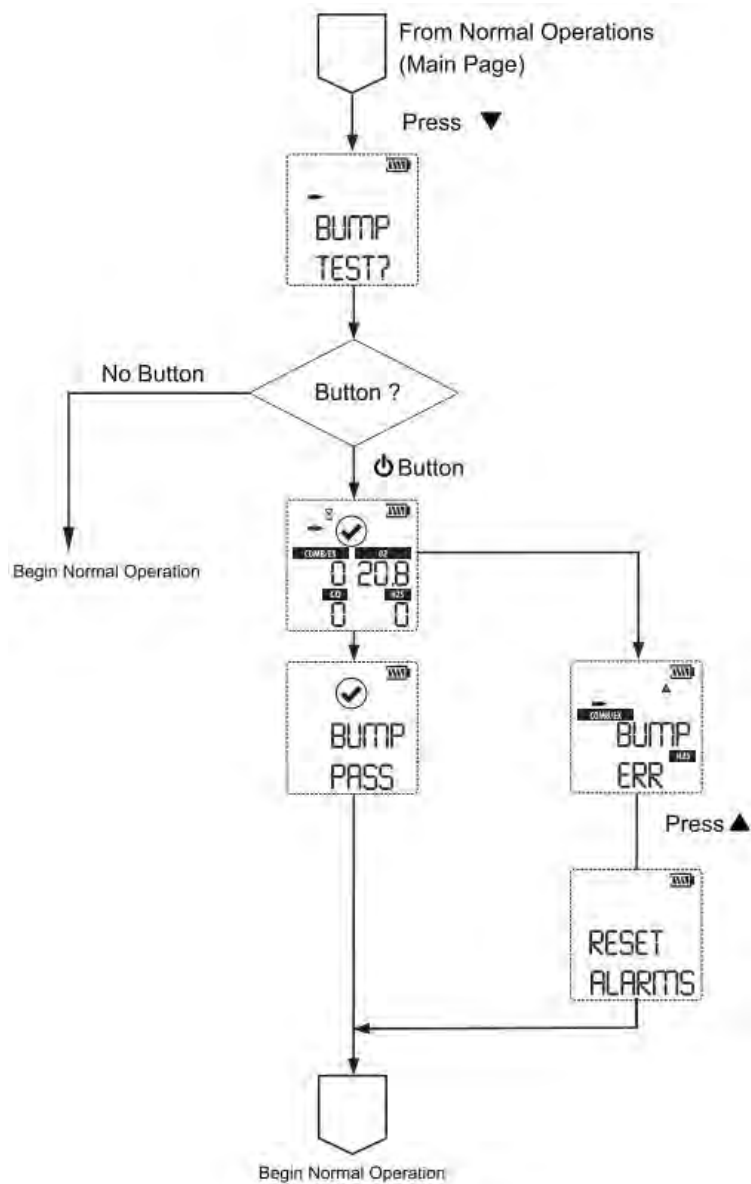

8.5 Options Setup

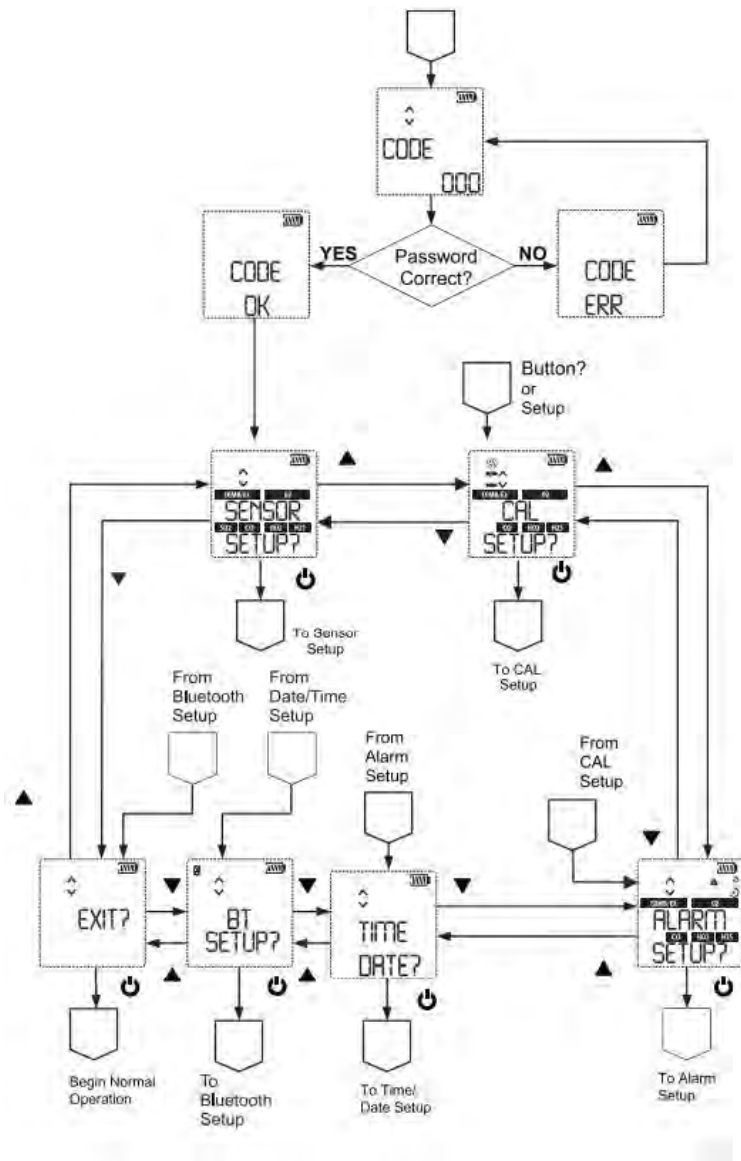

8.6 Sensor Setup

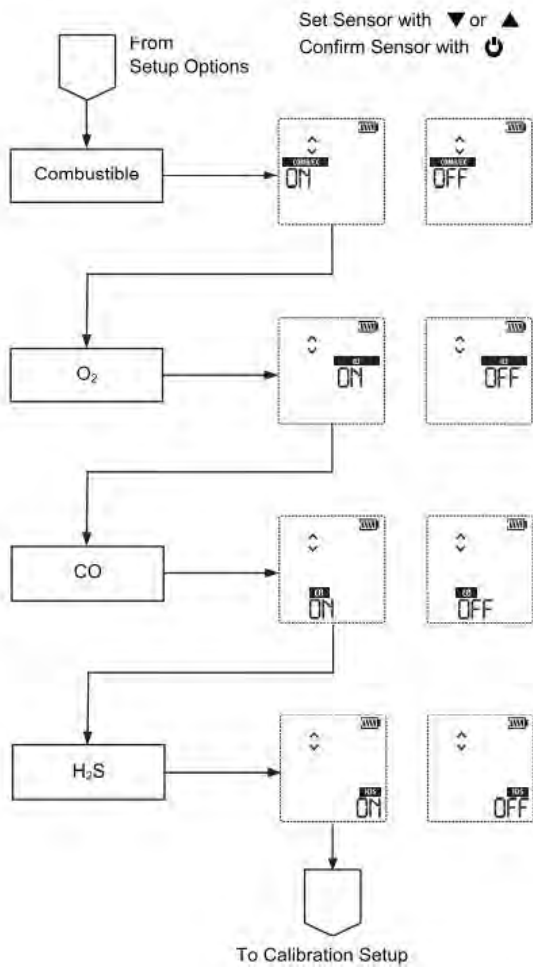

8.7 Calibrations

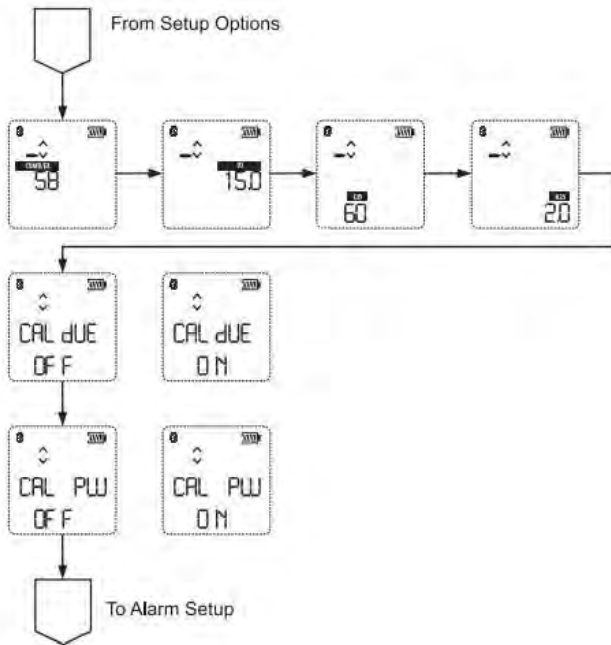
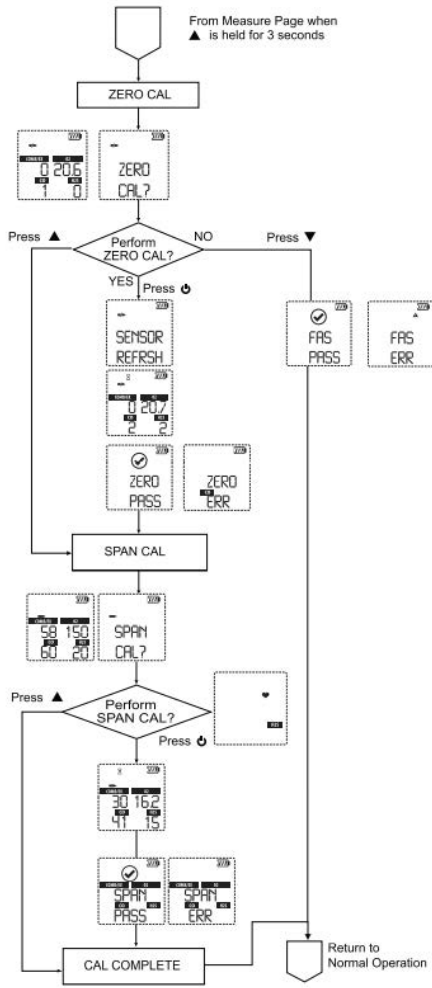

8.8 Alarm Setup

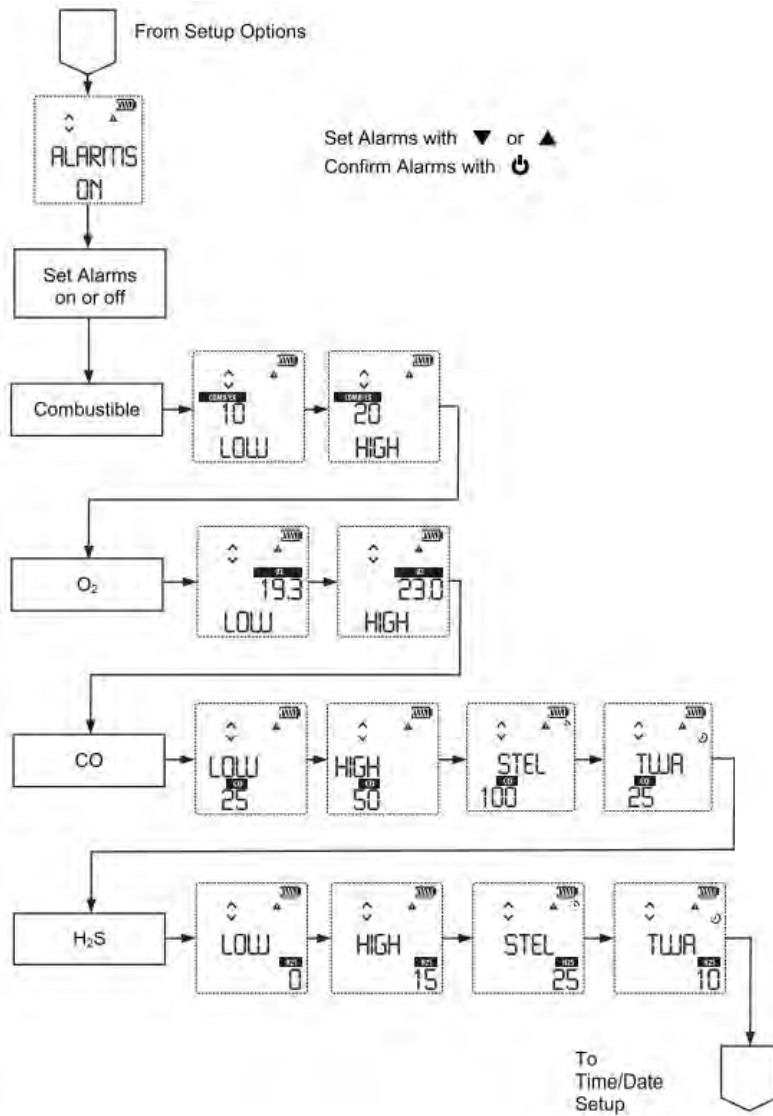

8.9 Time and Date Setup

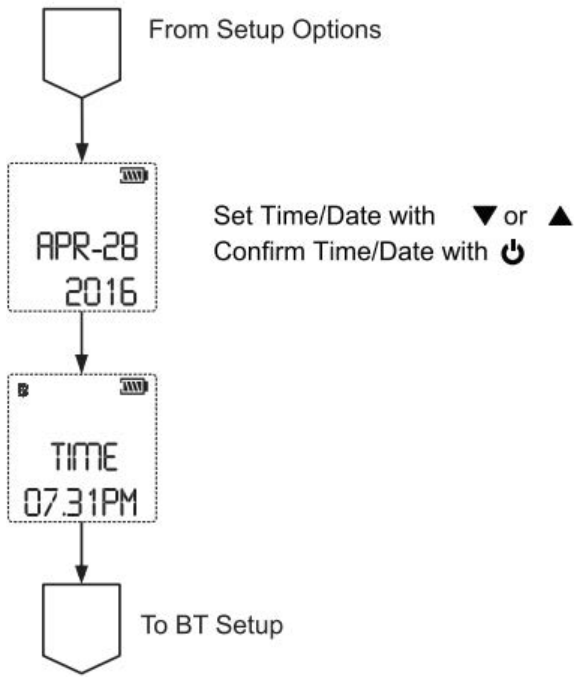

8.10 Bluetooth Setup

