

Actual Size Profile Chart

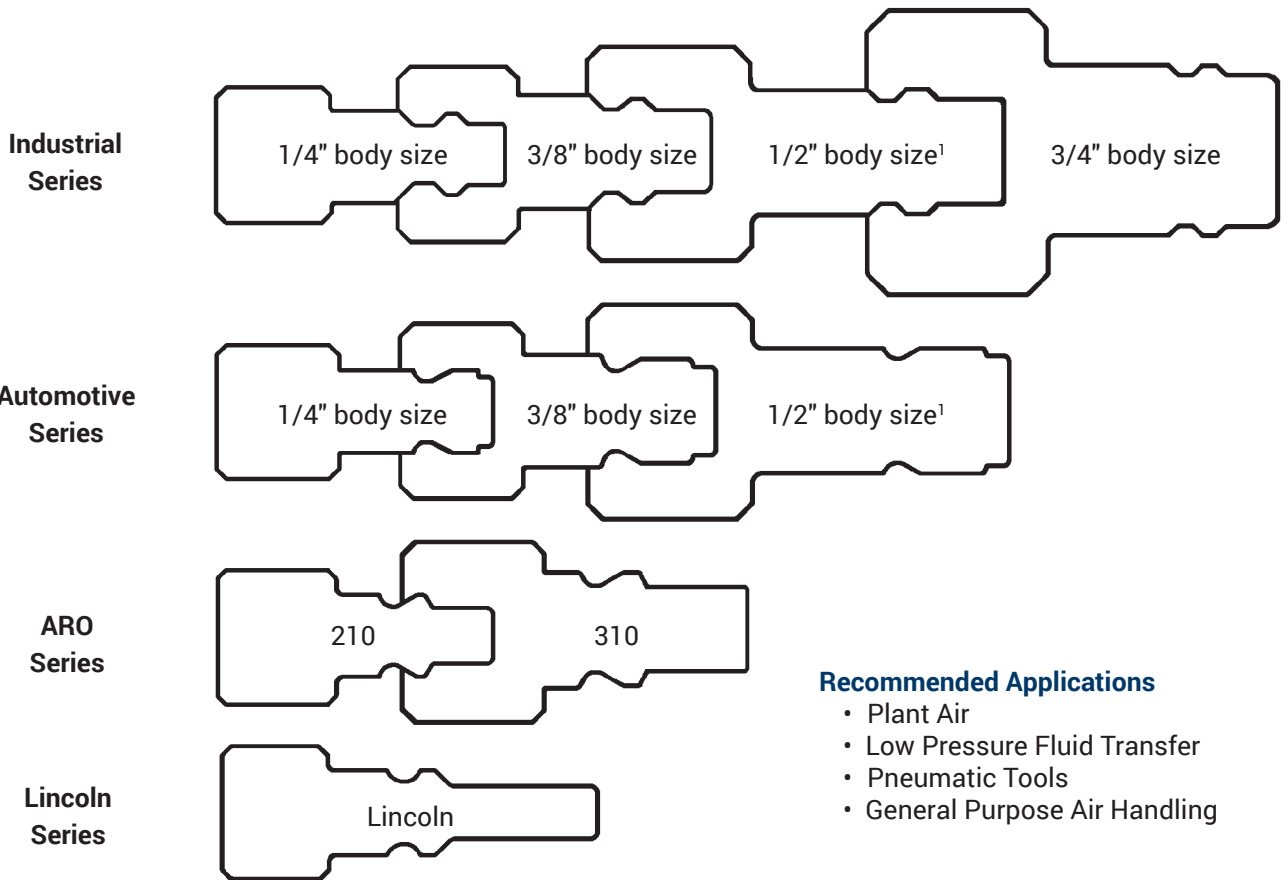

¹ 1/2" industrial series may also interchange with 1/2" automotive series



SAFETY



A short length whip hose is recommended on impact tools connected with these couplers to prevent premature wear caused by excessive vibration.

Dixon's couplings and retention devices are designed to work safely for their intended use. The selection of the proper hose, coupling and retention device, and the proper application of the coupling to the hose are of utmost importance.

Users must consider the size, temperature, application, media, pressure and hose, and coupling manufacturer's recommendations when selecting the proper hose assembly components. Dixon® recommends that all hose assemblies be tested in accordance with the Association for Rubber Products Manufacturer's (ARPM) recommendations and be inspected regularly (before each use) to ensure that they are not damaged or have become loose. Visit ARPMINC.com for more information.

Where safety devices are integral to the coupling, they must be working and utilized. The use of supplementary safety devices such as safety clips or safety cables are recommended.

If any problem is detected, couplings must be removed from service immediately.

Dixon is available to consult, train and recommend the proper selection and application of all fittings we sell. We strongly recommend that distributors and end users make use of Dixon's Testing and Recommendation Services. Call 877.963.4966 or click dixonvalve.com to learn more.

Semi-Automatic Design

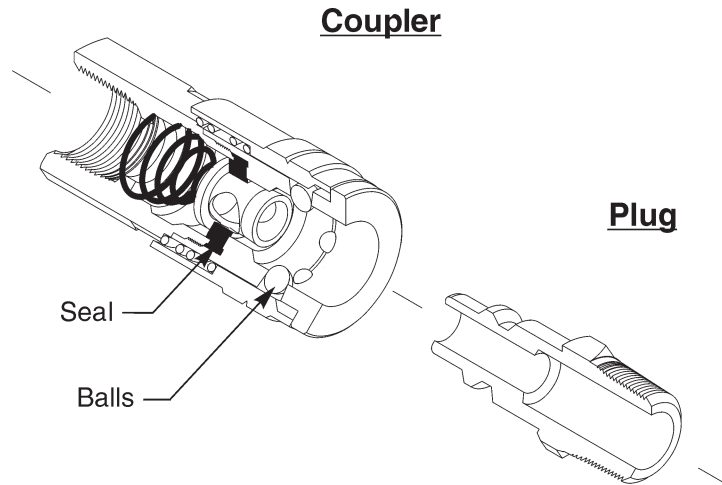

Semi-Automatic Quick-Connect Couplers are generally accepted as the fastest, easiest, and most reliable means of joining low pressure pneumatic lines.

Hardened balls or pins engage a groove in the coupler plug to hold it securely against a soft positive seal gasket. This also permits the assembly to swivel, which helps to prevent kinking or twisting of the hose. A sliding sleeve releases the locking balls or pins when retracted, permitting the plug to be inserted or removed. The sleeve automatically returns to the locked position when released. An automatic shut-off valve in the coupler seals when being uncoupled, eliminating the need for a separate shut-off.

Automatic Design

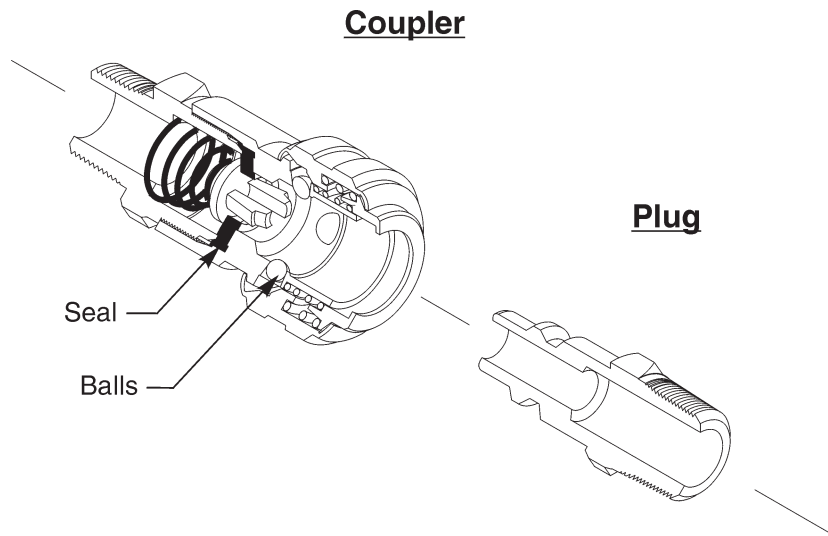

The Automatic Quick-Connect coupling design allows the user to connect and disconnect the fitting with one hand. The sleeve action is designed opposite of the conventional design which reduces the chance of accidental disconnect when pulled across obstacles.

Air Chief Universal Couplers

Universally compatible with multiple plug configurations.

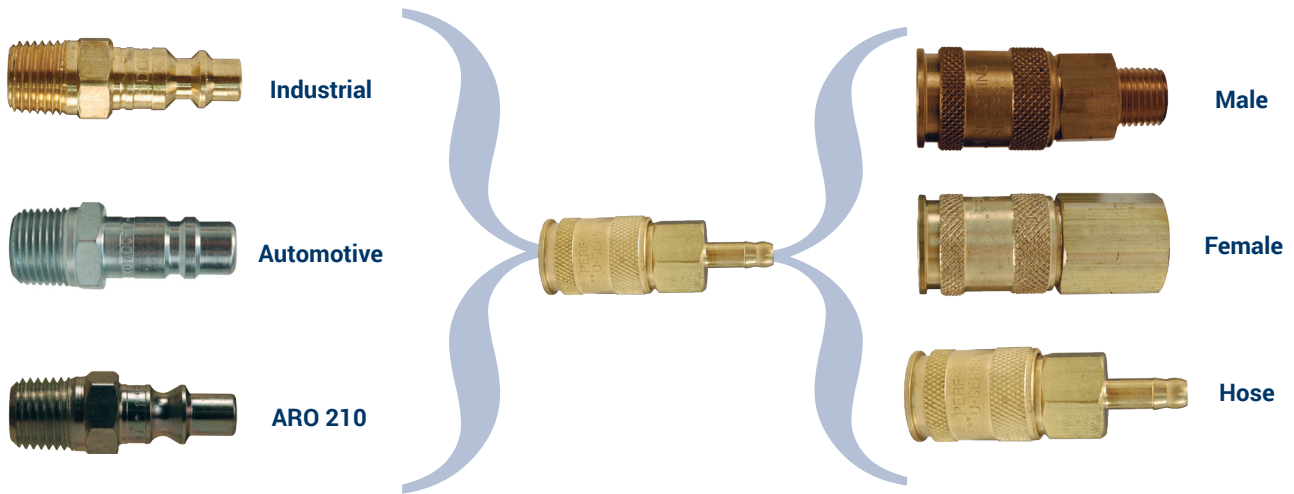

Ball Swivel Plug

Materials

- Threaded portion: brass
- Body: steel

Specification

- Pressure rating: 250 PSI
- Full flow at any angle

Industrial Ball Swivel Plug

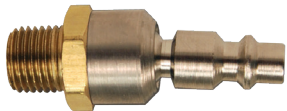

Body Size	Male NPT	Steel Part #
1/4"	1/4"	DCP21SWIV

Automotive Ball Swivel Plug

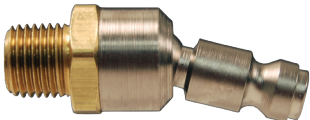

Body Size	Male NPT	Steel Part #
1/4"	1/4"	DCP1SWIV

ARO Ball Swivel Plug

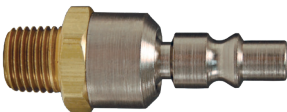

Body Size	Male NPT	Steel Part #
1/4"	1/4"	DCP37SWIV

Standard Ball Swivels

Features

- Brass and hardened steel construction
- O-ring seals
- Wobble action for increased flexibility with air driven tools



Hose Size	Male NPT	Part #
1/4"	1/4"	D444S
3/8"	1/4"	D446S

Air Chief Industrial Interchange Couplings

Features

- Interchanges with many other manufacturer's designs
- Interchanges with MIL Spec. MIL-C-4109F/A-A-59439 and ISO 6150-B
- For air service only



Specifications

- Pressure rating: **300 PSI**
- Temperature range: **-40°F to 250°F (-40°C to 121°C)**

Female Threaded Plugs

Body Size	Female NPT	Flow Rating at 100 PSI	Steel Part #
1/4"	1/8"	37 CFM	DCP2021
	1/4"	37 CFM	DCP20
	3/8"	37 CFM	DCP2023
3/8"	1/4"	70 CFM	DCP2622
	3/8"	70 CFM	DCP26
	1/2"	70 CFM	DCP2624
1/2"	3/8"	150 CFM	DCP1823
	1/2"	150 CFM	DCP18
	3/4"	150 CFM	DCP1826
3/4"	1/2"	200 CFM	DCP7024
	3/4"	200 CFM	DCP7026
	1"	200 CFM	DCP7028

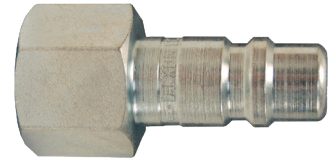

Male Threaded Plugs

Body Size	Male NPT	Flow Rating at 100 PSI	Steel Part #
1/4"	1/8"	37 CFM	DCP2101
	1/4"	37 CFM	DCP21
	3/8"	37 CFM	DCP2103
3/8"	1/4"	70 CFM	DCP2502
	3/8"	70 CFM	DCP25
	1/2"	70 CFM	DCP2504
1/2"	3/8"	150 CFM	DCP1703
	1/2"	150 CFM	DCP17
	3/4"	150 CFM	DCP1706
3/4"	1/2"	200 CFM	DCP7104
	3/4"	200 CFM	DCP7106
	1"	200 CFM	DCP7108



Air Chief Industrial Interchange Couplings

Features

- Interchanges with many other manufacturer's designs
- Interchanges with MIL Spec. MIL-C-41 09F/A-A-59439 and ISO 6150-B
- For air service only



Specifications

- Pressure rating: **300 PSI**
- Temperature range: **-40°F to 250°F (-40°C to 121°C)**

Standard Hose Barb Plugs



DCP7145

Body Size	Hose I.D.	Flow Rating at 100 PSI	Steel Part #
1/4"	5/16"	37 CFM	DCP2143
	3/8"	37 CFM	DCP2144
3/8"	1/2"	70 CFM	DCP2545
1/2"	3/4"	150 CFM	DCP1746
3/4"	1/2"	200 CFM	DCP7145
	3/4"	200 CFM	DCP7146
	1"	200 CFM	DCP7148

Push-On Hose Barb Plugs



Body Size	Hose I.D.	Flow Rating at 100 PSI	Steel Part #
1/4"	3/8"	37 CFM	DCP2144L
3/8"	1/4"	70 CFM	DCP2542L

Air Chief Industrial Interchange Couplings

Features

- Couplers shut off when disconnected
- Couplers are semi-automatic
- Interchanges with many other manufacturer's designs
- Interchanges with MIL Spec. MIL-C-4109F/A-A-59439 and ISO 6150-B
- For air service only 

Specifications

- Pressure rating: **300 PSI**
- Temperature range: **-40°F to 250°F (-40°C to 121°C)**

Semi-Automatic Female Threaded Couplers

Body Size	Female NPT	Flow Rating at 100 PSI	Brass Part #	Steel Part #
1/4"	1/8"	37 CFM	DC2021	---
	1/4"	37 CFM	DC20	---
	3/8"	37 CFM	DC2023	---
3/8"	1/4"	70 CFM	---	DC2622
	3/8"	70 CFM	---	DC26
	1/2"	70 CFM	---	DC2624
1/2"	3/8"	150 CFM	---	DC1023
	1/2"	150 CFM	---	DC10
	3/4"	150 CFM	---	DC1026

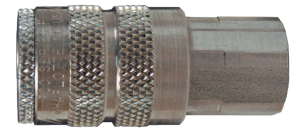

Male Threaded Couplers

Body Size	Male NPT	Flow Rating at 100 PSI	Brass Part #	Steel Part #
1/4"	1/8"	37 CFM	DC2101	---
	1/4"	37 CFM	DC21	---
	3/8"	37 CFM	DC2103	---
3/8"	1/4"	70 CFM	---	DC2502
	3/8"	70 CFM	---	DC25
	1/2"	70 CFM	---	DC2504
1/2"	3/8"	150 CFM	---	DC903
	1/2"	150 CFM	---	DC9
	3/4"	150 CFM	---	DC906



Standard Hose Barb Couplers

Body Size	Hose I.D.	Flow Rating at 100 PSI	Brass Part #	Steel Part #
1/4"	1/4"	37 CFM	DC2042	---
	5/16"	37 CFM	DC2043	---
	3/8"	37 CFM	DC2044	---
3/8"	3/8"	70 CFM	---	DC2644
	1/2"	70 CFM	---	DC2645
1/2"	3/8"	150 CFM	---	DC1044
	1/2"	150 CFM	---	DC1045
	3/4"	150 CFM	---	DC1046



Push-On Hose Barb Couplers

Body Size	Hose I.D.	Flow Rating at 100 PSI	Brass Part #	Steel Part #
1/4"	1/4"	37 CFM	DC2042L	---
	3/8"	37 CFM	DC2044L	---
3/8"	1/4"	70 CFM	---	DC2642L
	3/8"	70 CFM	---	DC2644L

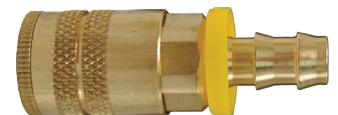

Air Chief Industrial Interchange Couplings

Features

- Couplers shut off when disconnected
- Couplers are automatic
- Interchanges with many other manufacturer's designs
- Interchanges with MIL Spec. MIL-C-4109F/A-A-59439
- For air service only 

Specifications

- Pressure rating: **300 PSI**
- Temperature range: **-40°F to 250°F (-40°C to 121°C)**

Automatic

Female Threaded Couplers



Body Size	Female NPT	Flow Rating at 100 PSI	Brass Part #
3/4"	1/2"	190 CFM	DC7024
	3/4"	190 CFM	DC7026
	1"	190 CFM	DC7028

Male Threaded Couplers



Body Size	Male NPT	Flow Rating at 100 PSI	Brass Part #
3/4"	1/2"	190 CFM	DC7104
	3/4"	190 CFM	DC7106
	1"	190 CFM	DC7108

Standard Hose Barb Couplers

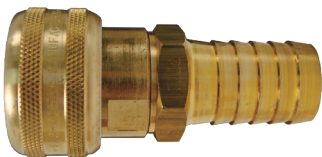

Body Size	Hose I.D.	Flow Rating at 100 PSI	Brass Part #
3/4"	1/2"	190 CFM	DC7045
	3/4"	190 CFM	DC7046
	1"	190 CFM	DC7048

Parker E-z-mate Industrial Couplings

E-z-mate couplings combine push-to-connect, exhaust-style action with a self-locking valve sleeve to guard against accidental disconnection. Simply follow the direction of the on-off arrow stamped on the yellow chromate valve sleeve. Valve sleeve acts as an integral shut off valve that allows connection and disconnection at zero pressure. When the sleeve is moved to shut off air flow, it automatically vents downstream allowing for disconnection at zero pressure and eliminating the risk of hose whip.

Features

- Meets ISO 4414 requirements for a controlled pressure release system
- Not recommended for vacuum service 

Specifications

- Pressure rating: **300 PSI**
- Temperature range (standard seals): **-40°F to 250°F (-40°C to 121°C)**

Female Threaded Couplers

Body Size	Female NPT	Flow Rating at 100 PSI	Steel Part #
1/4"	1/4"-18	37 CFM	DC20SE
	3/8"-18	37 CFM	DC2023SE
3/8"	3/8"-18	70 CFM	DC26SE
	1/2"-14	70 CFM	DC2624SE
1/2"	1/2"-14	150 CFM	DC10SE
	3/4"-14	150 CFM	DC1026SE
3/4"	3/4"-14	200 CFM	DC7026SE
	1"-11-1/2	200 CFM	DC7028SE



Male Threaded Couplers

Body Size	Male NPT	Flow Rating at 100 PSI	Steel Part #
1/4"	1/4"-18	37 CFM	DC21SE
	3/8"-18	37 CFM	DC2103SE
3/8"	3/8"-18	70 CFM	DC25SE
1/2"	1/2"-14	150 CFM	DC9SE
3/4"	3/4"-14	200 CFM	DC7106SE



Standard Hose Barb Couplers

Body Size	Hose I.D.	Flow Rating at 100 PSI	Steel Part #
1/4"	1/4"	37 CFM	DC2042SE
	3/8"	37 CFM	DC2044SE
3/8"	3/8"	70 CFM	DC2644SE
1/2"	1/2"	150 CFM	DC1045SE



Push-Lock Hose Barb Couplers

Body Size	Hose I.D.	Flow Rating at 100 PSI	Steel Part #
1/4"	1/4"	37 CFM	DC2042LSE
	3/8"	37 CFM	DC2044LSE
3/8"	3/8"	70 CFM	DC2644LSE
1/2"	1/2"	150 CFM	DC1045LSE



Legris Industrial Interchange Safety Couplers

Applications

- Suited for numerous installations including: pneumatic tools, blow guns, pneumatic automotive equipment

Features

- Composite, non-marring body
- 1/4" body size ensures excellent flow and total security due to disconnection in two steps
- Compatible with industrial interchange plugs
- For compressed air only
- Conforms to MIL-C-4109F, ISO 6150-B

Specifications

- Temperature range: **-4°F to 140°F (-40°C to 121°C)**
- Working pressure: **230 PSI**



1. vents plug side



2. disconnects

Female Threaded Automatic Couplers



Body Size	NPT Size	Part #
1/4"	1/4"	9415U0614
	3/8"	9415U0618

Male Threaded Automatic Couplers

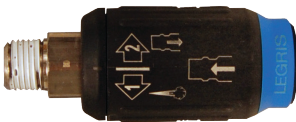

Body Size	NPT Size	Part #
1/4"	1/4"	9405U0614
	3/8"	9405U0618

Air Chief Automotive Interchange Couplings

Features

- Couplers are semi-automatic
- Interchange with popular makes of automotive quick-connect fittings such as Amflo, Dill, Milton, and Tru-Flate, some designs do not interchange with others, if you plan to interchange these couplings, make sure you have plug ends with the proper configuration

Specifications

- Pressure rating: **300 PSI**
- Temperature range: **-40°F to 250°F (-40°C to 121°C)**

Semi-Automatic

Female Threaded Plugs

Body Size	Female NPT	Flow Rating at 100 PSI	Steel Part #
1/4"	1/8"	37 CFM	DCP221
	1/4"	37 CFM	DCP2
	3/8"	37 CFM	DCP223
3/8"	1/4"	70 CFM	DCP8
	3/8"	70 CFM	DCP6
	1/2"	70 CFM	DCP624

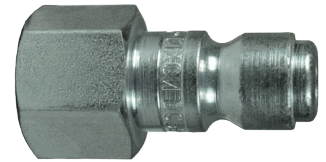

Male Threaded Plugs

Body Size	Male NPT	Flow Rating at 100 PSI	Steel Part #
1/4"	1/8"	37 CFM	DCP101
	1/4"	37 CFM	DCP1
	3/8"	37 CFM	DCP103
3/8"	1/4"	70 CFM	DCP7
	3/8"	70 CFM	DCP5



Standard Hose Barb Plugs

Body Size	Hose I.D.	Flow Rating at 100 PSI	Steel Part #
1/4"	1/4"	37 CFM	DCP142
	3/8"	37 CFM	DCP144
3/8"	3/8"	37 CFM	DCP544



Push-On Hose Barb Plugs

Body Size	Hose I.D.	Flow Rating at 100 PSI	Steel Part #
1/4"	1/4"	37 CFM	DCP142L
	3/8"	37 CFM	DCP144L
3/8"	3/8"	70 CFM	DCP544L

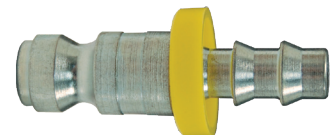

Air Chief Automotive Interchange Couplings

Features

- Couplers are semi-automatic
- Interchange with popular makes of automotive quick-connect fittings such as Amflo, Dill, Milton, and Tru-Flate, some designs do not interchange with others, if you plan to interchange these couplings, make sure you have plug ends with the proper configuration

Specifications

- Pressure rating: **300 PSI**
- Temperature range: **-40°F to 250°F (-40°C to 121°C)**

Semi-Automatic

Female Threaded Couplers

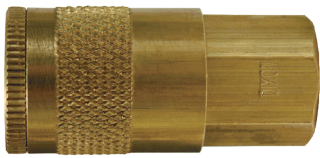

Body Size	Female NPT	Flow Rating at 100 PSI	Brass Part #	Steel Part #
1/4"	1/8"	37 CFM	DC221	---
	1/4"	37 CFM	DC2	---
	3/8"	37 CFM	DC223	---
3/8"	1/4"	70 CFM	---	DC8
	3/8"	70 CFM	---	DC6
	1/2"	70 CFM	---	DC624

Male Threaded Couplers

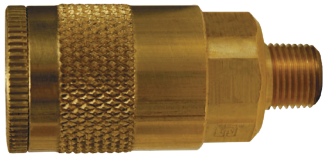

Body Size	Male NPT	Flow Rating at 100 PSI	Brass Part #	Steel Part #
1/4"	1/8"	37 CFM	DC101	---
	1/4"	37 CFM	DC1	---
	3/8"	37 CFM	DC103	---
3/8"	1/4"	70 CFM	---	DC7
	3/8"	70 CFM	---	DC5
	1/2"	70 CFM	---	DC504

Standard Hose Barb Couplers



Body Size	Hose I.D.	Flow Rating at 100 PSI	Brass Part #	Steel Part #
1/4"	1/4"	37 CFM	DC242	---
	3/8"	37 CFM	DC244	---
3/8"	3/8"	70 CFM	---	DC644
	1/2"	70 CFM	---	DC645

Push-On Hose Barb Couplers

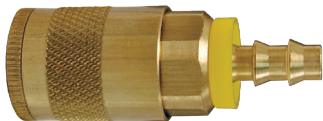

Body Size	Hose I.D.	Flow Rating at 100 PSI	Brass Part #	Steel Part #
1/4"	1/4"	37 CFM	DC242L	---
	3/8"	37 CFM	DC244L	---
3/8"	3/8"	70 CFM	---	DC644L

Air Chief Automotive Actual Size Profile Charts

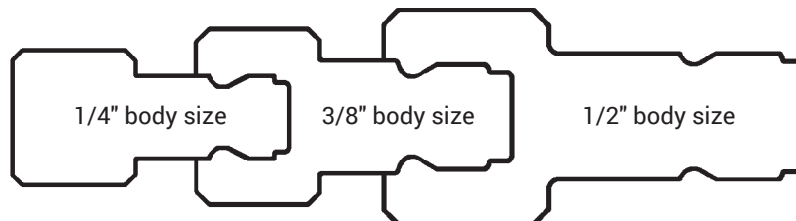

Air Chief ARO Speed Interchange Couplings

Features

- Interchanges with ARO 210 and 310 designs
- Couplers shut off when disconnected

Specification

- Pressure rating: **300 PSI** at ambient temperature **70°F (21°C)**
- Temperature range: **-40°F to 250°F (-40°C to 121°C)**

Female Threaded Plugs

Body Size	Female NPT	Flow Rating at 100 PSI	Steel Part #
1/4"	1/4"	37 CFM	DCP38
	3/8"	37 CFM	DCP3823
3/8"	3/8"	70 CFM	DCP36



Male Threaded Plugs

Body Size	Male NPT	Flow Rating at 100 PSI	Steel Part #
1/4"	1/4"	37 CFM	DCP37
	3/8"	37 CFM	DCP3703
3/8"	3/8"	70 CFM	DCP35



Standard Hose Barb

Body Size	Hose I.D.	Flow Rating at 100 PSI	Steel Part #
1/4"	1/4"	37 CFM	DCP3742



Push-On Hose Barbs

Body Size	Hose I.D.	Flow Rating at 100 PSI	Steel Part #
1/4"	1/4"	37 CFM	DCP3742L
	3/8"	37 CFM	DCP3744L

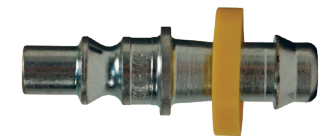

Air Chief ARO Speed Interchange Couplings

Semi-Auto Female Threaded Couplers

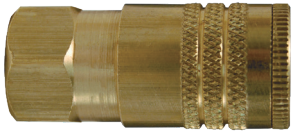

Body Size	Hose I.D.	Flow Rating at 100 PSI	Brass Part #	Steel Part #
1/4"	1/4"	37 CFM	DC38	---
	3/8"	37 CFM	DC3823	---
3/8"	3/8"	70 CFM	---	DC36

Semi-Auto Male Threaded Couplers

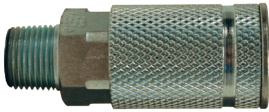

Body Size	Hose I.D.	Flow Rating at 100 PSI	Brass Part #	Steel Part #
1/4"	1/4"	37 CFM	DC37	---
	3/8"	37 CFM	DC3703	---
3/8"	3/8"	70 CFM	---	DC35

Semi-Auto Standard Hose Barb Couplers

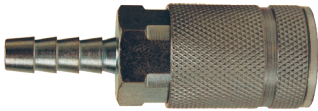

Body Size	Hose I.D.	Flow Rating at 100 PSI	Steel Part #
1/4"	1/4"	37 CFM	DC3842
	3/8"	37 CFM	DC3844

Semi-Auto Push-On Hose Barb Couplers

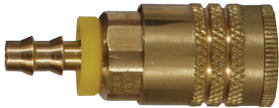

Body Size	Hose I.D.	Flow Rating at 100 PSI	Brass Part #
1/4"	1/4"	37 CFM	DC3842L
	3/8"	37 CFM	DC3844L

Air Chief ARO Actual Size Profile Charts

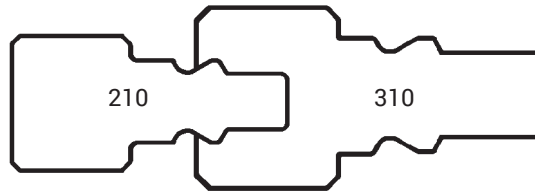

Air Chief Lincoln Interchange Couplings

Features

- Interchangeable with the Lincoln Interchange long stem series
- Couplers shut off when disconnected
- Couplers are semi-automatic

Specification

- Pressure rating: **300 PSI** at ambient temperature **70°F (21°C)**
- Temperature range: **-40°F to 250°F (-40°C to 121°C)**

Female Threaded Plug

Body Size	Female NPT	Flow Rating at 100 PSI	Steel Part #
1/4"	1/4"	37 CFM	DCP28



Male Threaded Plug

Body Size	Male NPT	Flow Rating at 100 PSI	Steel Part #
1/4"	1/4"	37 CFM	DCP27



Female Threaded Coupler

Body Size	Female NPT	Flow Rating at 100 PSI	Brass Part #
1/4"	1/4"	37 CFM	DC28

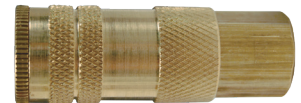

Male Threaded Coupler

Body Size	Female NPT	Flow Rating at 100 PSI	Brass Part #
1/4"	1/4"	37 CFM	DC27



Air Chief Lincoln Actual Size Profile Chart

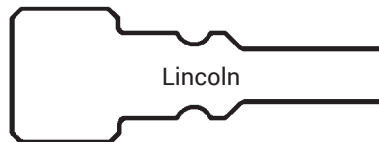

Bar Manifolds

Features

- Can be mounted on a wall or work bench, safely distributing four hose lines to a work area
- Maximum operating pressure: **300 PSI** at ambient temperature **70°F (21°C)**

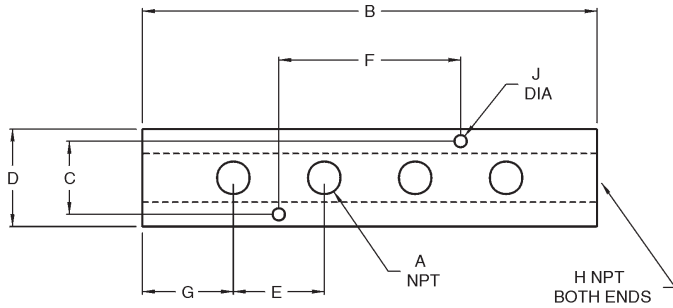

Dimensions

Aluminum Part #	A	B	C	D	E	F	G	H	J
AMF32	1/4"	7-5/8"	7/8"	1-1/4"	1-7/8"	3-3/4"	1"	3/8"	.20"
AMF42	1/4"	7-5/8"	1-1/8"	1-1/2"	1-7/8"	3-3/4"	1"	1/2"	.20"
AMF43	3/8"	8"	1-1/8"	1-1/2"	2"	4"	1"	1/2"	.20"

3 in 1 Manifolds

Features

- Supplies 3 air operated tools from a single hose permitting use of air by more than one mechanic
- Can be mounted to a pipe at workbench or overhead
- Different tools in the shop use different styles of couplers, mount 3 different style couplers on one manifold

NPT Inlet (1)	NPT Outlets (3)	Aluminum Part #
1/4"	1/4"	D3404
3/8"	1/4"	D3406
1/2"	1/4"	D3408



Flat Hex Manifolds

Feature

- Designed to lay flat on the floor, safely distributing three hose lines to the work area

NPT Inlet (1)	NPT Outlets (3)	Brass Part #
1/4"	1/4"	3122
3/8"	1/4"	3132
3/8"	3/8"	3133

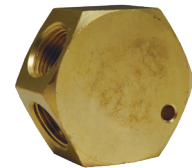

Compressor Y

Feature

- Converts a single supply source to a dual outlet

Female NPT Inlet (1)	Male NPT Outlets (2)	Iron Part #
1"	3/4"	Y10075



In-Line Lubricators

Features

- Protects portable or stationary air tools by efficiently oiling the tool mechanisms; each time an air tool is operated a fine mist of oil is injected into it along with the air from the compressor
- Installation is recommended within 25' of the tool to be lubricated, refer to the arrow for proper air flow direction
- Transparent sight disc allows visual inspection of oil level
- Oil flow regulated by screwdriver screw adjustment; minimum flow rate is 30 SCFM
- Not recommended for constant flow applications
- For reciprocating tools only
- Type of oil to use: any petroleum-based, non-detergent lightweight oil (SAE 10/150SSU) which will readily break up into a mist, i.e., Mobil DTE light or comparable oil, do not use any synthetic oil or oils containing additives or solvents
- See page 273 for air tool lubricant



NPT Size	Oil Capacity	Maximum Working Pressure at Ambient Temperature (70°F)	Air Flow at 70 PSI	Aluminum Part #
1/2"	1.4 fluid ozs.	500 PSI	30 SCFM	PL300
3/4"	3.7 fluid ozs.	200 PSI	70 SCFM	PL400
3/4"	11.0 fluid ozs.	300 PSI	70 SCFM	PL400L
1"	16.0 fluid ozs.	250 PSI	100 SCFM	PL500

Replacement Parts

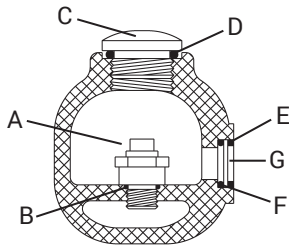

Description	Part #
(A) oil adjustment valve assembly	851661
(B) valve gasket	452531
(C) fill plug	452525
(D) fill plug O-ring	700013-214
(E) sight disk	452532
(F) sight disk seal	700013-016
(G) sight disk lock nut	452533

In-Line Air Filter

Features

- Protects small air tools, such as impact wrenches, nut runners, grinders, and screwdrivers
- All-anodized, compact housing
- Install directly before the air tool
- Male x female configuration
- Standard 40 micron element ensures minimum pressure drop
- Elements can be replaced quickly



Specifications

- Maximum operating pressure: 500 PSI
- Temperature range: 35°F to 200°F (2°C to 93°C)
- Air flow: 140 SCFM

Male NPT	Overall Length	Diameter	Aluminum Part #
3/4"	3-13/16"	1-1/2"	9076M

Disposable In-Line Nipple Filters



Features

- For filtration of water, oil, and air
- Compact and lightweight
- Can be installed at point of use
- Shape element is conical rather than disc, providing a larger filtering flow and a true, uninterrupted axial flow
- Available in 40 micron or 90 micron

Specifications

- Maximum operating pressure: **300 PSI**
- Temperature range: **35°F to 300°F (2°C to 149°C)**

Male NPT	Overall Length	Hex	Air Flow	Brass Part #
1/8"	1-1/4"	7/16"	10 SCFM	ASP3101-40
				ASP3101-90
1/4"	1-1/2"	9/16"	20 SCFM	ASP3102-40
				ASP3102-90
3/8"	1-3/4"	11/16"	30 SCFM	ASP3103-40
				ASP3103-90
1/2"	2"	7/8"	50 SCFM	ASP3104-40
				ASP3104-90

In-Line Lubricators with Filters

Feature

- Consists of 9076M particle filter with 40 micron sintered bronze element and PL400 (3.7 ounce) or PL400L (11.0 ounce) lubricator



NPT Size	Oil Capacity	Max. Working Pressure at Ambient Temperature 70°F (21°C)	Aluminum Part #
3/4"	3.7 fluid ozs.	200 PSI	PL400WF
	11.0 fluid ozs.	300 PSI	PL400LWF

Mini In-Line Lubricators

Features

- Cannot be filled under pressure
- Oil capacity: 1/4 fluid ounce

Specifications

- Flow rating: 22 SCFM at 100 PSIG
- Maximum operating pressure: 200 PSIG
- Maximum temperature: **150°F (66°C)**



Female NPT Inlet	Outlet	Aluminum Part #
1/4"	1/4" female NPT	ML200
	1/4" male NPT	ML200M
3/8"	3/8" male NPT	ML300M

Mini In-Line Filter

Features

- Either port may be used as an inlet port
- Filter element rated at 5 microns

Specifications

- Flow rating: 17 SCFM inlet pressure at 90 PSIG with **5 PSI** pressure drop
- Maximum operating pressure: 200 PSIG
- Temperature range: **32°F to 150°F (0°C to 66°C)**



Female NPT	Male NPT	Aluminum Part #
1/4"	1/4"	MF200

Conical Mufflers

Application

- Threads into the exhaust ports of air tool, valves, cylinders, and other pneumatic equipment

Features

- Reduces noise levels below 90 dBA to conform with OSHA standards
- 40 micron bronze filter element
- Element is bonded directly to the fitting and is not replaceable

Specifications

- Maximum operating pressure: **300 PSI**
- Temperature range: **35°F to 300°F (2°C to 149°C)**

NPT Thread	Overall Length	Nickel-Plated Steel Part #
1/8"	1-1/8"	CMF18
1/4"	1-3/8"	CMF28
3/8"	1-1/2"	CMF38
1/2"	1-7/8"	CMF48
3/4"	2-1/4"	CMF68
1"	2-7/8"	CMF88



Speed Control Mufflers

Features

- Safe and infinite variations of metering air flow at acceptable sound levels on exhaust ports of air valves
- Speed of operating cylinder or air tool may be increased or decreased with adjusting screw; the final position is locked in place by the lock nut
- Exhaust air noise is eliminated by a surrounding sleeve of sintered bronze
- Element: 40 micron sintered bronze

Specifications

- Maximum operating pressure: **300 PSI**
- Temperature range: **35°F to 300°F (2°C to 149°C)**

NPT Thread	Approximate Full Operating Height	Maximum Adjusted SCFM	Brass Part #
1/8"	1-5/16"	30	SCM18
1/4"	1-9/16"	40	SCM28
3/8"	1-5/8"	62	SCM38
1/2"	2"	103	SCM48
3/4"	2-3/8"	110	SCM68
1"	2-1/2"	140	SCM88



brass

Breather Vents

Applications

- Used on single-acting cylinders or valves to prevent dirt and foreign particles from entering ports open to the atmosphere
- Provides vacuum relief or pressure equalization on gear boxes, oil tanks, or reservoirs

Features

- Standard pipe thread connections for quick assembly and removal for cleaning
- Nickel plated steel insert with a bronze filter
- 40 micron filter element

Specifications

- Maximum operating pressure: **150 PSI**
- Temperature range: **35°F to 300°F (2°C to 149°C)**

NPT Thread	Overall Length	Nickel-Plated Steel Part #
1/8"	7/16"	ASP-1BV
1/4"	5/8"	ASP-2BV
3/8"	3/4"	ASP-3BV
1/2"	7/8"	ASP-4BV
3/4"	1"	ASP-6BV
1"	1-5/16"	ASP-8BV



Brass Needle Valves

Features

- Metal-to-metal seats allow positive sealing and flow adjustment
- Designed for air and water applications
- Maximum working pressure: **150 PSI** at ambient temperature (70°F)

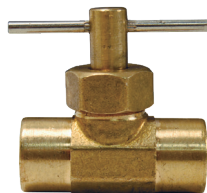

Female NPT	Female NPT	Brass Part #
1/8"	1/8"	NV2F
1/4"	1/4"	NV4F

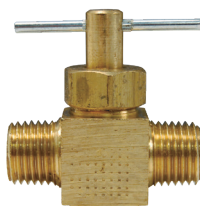

Male NPT	Male NPT	Brass Part #
1/4"	1/4"	NV4M

In-Line Swivels

Features

- For air service only 
- Rated to **250 PSI** at ambient temperature (70°F), minimum **35 PSI**
- Heavy-duty, free turning steel swivel

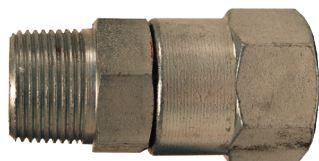

Male NPT	Female NPT	Steel Part #
3/8"	1/2"	SV17
1/2"	1/2"	SV20
3/4"	3/4"	SV26

Features

- For air service only 
- Rated to **150 PSI** at ambient temperature (70°F)

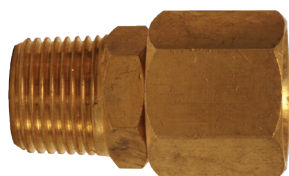

Male NPT	Female NPT	Brass Part #
1/4"	1/4"	D344R
3/8"	3/8"	D366R

Air Tool Swivels

Features

- Swivels at two locations so air hose can drop directly to the floor
- Rated to **150 PSI** at ambient temperature (70°F)
- Do not use with percussion tools 



D344U



D346U, D348U

Size	Aluminum Part #
1/4"	D344U ¹
3/8"	D346U
1/2"	D348U

¹D344U is a non-marring composite.

Valves

Button

Thread	Brass Part #
1/4" NPT female	BV2F
1/4" NPT male	BV2M



Tank Filler

Applications

- Used on compressed air tanks and other applications

Feature

- Standard valve stem thread

Connection	Length	Nickel-Plated Part #	Length	Brass Part #
1/8" NPT	.85"	TFV1S	---	---
	1.24"	TFV1L	---	---
1/4" NPT	1"	TFV2	---	---
1/4" barb	---	---	1.57"	TFV2HB



TFV1S



TFV2



TFV1L



TFV2HB

Brass Lever External Drains

Application

- For air service only

Specification

- Maximum operating pressure: 30 PSI at ambient temperature 70°F (21°C)

Female NPT	Male NPT	Brass Part #
1/4"	1/4"	LDC2

Male NPT	Male NPT	Brass Part #
1/4"	1/4"	LDCM2

Female NPT	Female NPT	Brass Part #
1/4"	1/4"	LDCF2

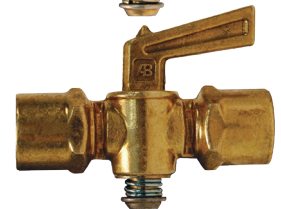
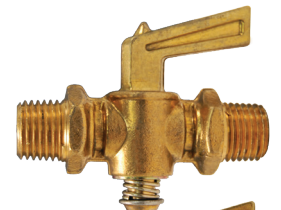
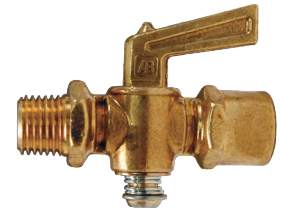

Brass External Drain Cocks

Application

- Designed for low pressure water and air applications

Specification

- Maximum operating pressure: 150 PSI at ambient temperature 70°F (21°C)
- Temperature range: -65°F to 250°F (-54°C to 121°C)

NPT Size	Brass Part #
1/8"	D02
1/4"	D04



Flow Control Valves

Brass Series-F

Features

- Provides precision flow control and full shutoff in one flow direction; automatically allows unrestricted flow in the opposite direction
- Two-step needle for fine adjustments at low flow with first three turns of the adjusting knob; next three turns give full-open needle position and conventional throttling control
- When flow is reversed the heavy-duty poppet/retainer permits full flow return capacity
- Color coded scale simplifies flow setting, resetting, adjusting, and return to an original flow
- A set screw locks the valve on any desired setting

Material

- Seal: Nitrile

Specifications

- 1/8" - 3/4" maximum operating pressure: **2,000 PSI** at ambient temperature **70°F (21°C)**, **1" 500 PSI** at ambient temperature **70°F (21°C)**
- Operating temperature range: **-20°F to 250°F (-29°C to 121°C)**
- Cracking pressure: **5 PSI**



Female NPTF	Brass Part #
1/8"	BFC200
1/4"	BFC400
3/8"	BFC600
1/2"	BFC800
3/4"	BFC1200
1"	BFC1600

Brass Series-N

Features

- For use as speed control on hydraulic and pneumatic systems where a reverse flow check valve is not needed
- Provides excellent control and reliable shutoff in a very small envelope
- Color-coded scale simplifies setting, resetting, adjusting, and quick return to a previous speed setting

Material

- Seal: Nitrile

Specifications

- 1/8" - 3/4" maximum operating pressure: **2,000 PSI** at ambient temperature **70°F (21°C)**, **1" 500 PSI** at ambient temperature **70°F (21°C)**
- Operating temperature range: **-20°F to 250°F (-29°C to 121°C)**
- Cracking pressure: **5 PSI**



Female NPTF	Brass Part #
1/8"	BN200
1/4"	BN400
3/8"	BN600
1/2"	BN800
3/4"	BN1200
1"	BN1600

Series-C Check Valves

Feature

- Provides free flow in one direction and dependable shutoff in the opposite direction

Material

- Seal: Nitrile

Specifications

- Maximum operating pressure: Brass **2,000 PSI** at **70°F (21°C)**; Steel **5,000 PSI** at **70°F (21°C)**
- Cracking pressure: **5 PSI**



brass



steel

Female NPT	Free Flow GPM	Maximum Operating PSI at 70°F (21°C)	Brass Part #	Maximum Operating PSI at 70°F (21°C)	Steel Part #
1/8"	3	2,000	BCV200	5,000	SCV200
1/4"	5	2,000	BCV400	5,000	SCV400
3/8"	8	2,000	BCV600	5,000	SCV600
1/2"	15	2,000	BCV800	5,000	SCV800

Safety Pop-Off Valves

Applications

- For use on compressors and in compressed air service

Feature

- Designed to protect un-fired pressure vessels from over-pressure

Specifications

- ASME Code, National Board Certified
- CSA B51-03 certified
- Maximum temperature: 400°F (204°C)

Soft Seat

Feature

- Constructed of precision machined brass bar stock with a silicone disc sealing on the brass

Male NPT	Preset Pressure PSI	SCFM	Brass Part #
1/4"	100	51	KSV10-100
	125	62	KSV10-125
	150	73	KSV10-150
	175	84	KSV10-175



Standard

Features

- Brass valves are supplied with a stainless steel ball and silicone disc
- Stainless valves are all stainless construction with a soft seat

Male NPT	Preset Pressure PSI	SCFM	Brass Part #	SCFM	Stainless Steel Part #
1/4"	30	30	SV30	35	SV30SS
	100	90	SV100	92	SV100SS
	125	110	SV125	112	SV125SS
	150	130	SV150	132	SV150SS
	175	150	SV175	153	SV175SS
	200	170	SV200	173	SV200SS



brass



stainless steel

Heavy Duty, High Capacity

Feature

- All brass construction with stainless steel ball on a precision machined brass seat

Male NPT	Preset Pressure PSI	SCFM	Brass Part #
1/2"	30	73	SV30HD ¹
	100	208	SV100HD
	125	254	SV125HD
	150	300	SV150HD
	175	346	SV175HD
	200	391	SV200HD



¹Constructed with soft seat

Safety Blow Guns

Safety blow guns have a safety tip which prevents buildup of tip pressure in the event the outlet is obstructed or "dead ended". They comply with the requirements for OSHA 1910.242 (B) and 1910.95 when used on air lines of **150 PSI** or less.



Features

- Design comfortably fits contour of the hand minimizing user fatigue
- Ergonomic large lever with black vinyl grip allows for easy air flow activation
- 1/4" female NPT inlet

Air Chief

The Air Chief safety blow gun is designed to conform to OSHA Standard 1910.242 (B) permitting a maximum of **30 PSI** outlet pressure when dead ended based on a maximum of **150 PSI** inlet pressure as well as OSHA Standard 1910.95 regulating occupational noise level exposure. Safety glasses or shield must be worn when using any blow gun.



Features

- Recessed internal slotted screw allows easy access to valve assembly for repairs or replacement
- Chrome-plated zinc die cast body, nickel-plated steel lever, vinyl thumb grip, stainless steel spring, brass valve, nitrile rubber seals, and nickel-plated brass tip combine for superior corrosion resistance

Part

D204-30

Premium

The premium safety blow gun is designed to conform to OSHA Standard 1910.242 (B) permitting a maximum of **30 PSI** outlet pressure when dead ended based on a maximum of **150 PSI** inlet pressure as well as OSHA Standard 1910.95 regulating occupational noise level exposure. Safety glasses or shield must be worn when using any blow gun.



Feature

- Zinc die cast body with a black powder coat finish, nickel-plated steel lever, vinyl thumb grip, stainless steel spring, brass valve, nitrile rubber seals, and nickel-plated brass tip

Part

D204-30P

Safety Air Booster

The multiple holes in the safety booster tip of the safety air booster gun create a venturi effect that increases air flow (working capacity) while still remaining compliant with OSHA Standard 1910.242 (B). Safety glasses or shield must be worn when using any blow gun.



Feature

- Chrome-plated zinc die cast body, nickel-plated steel lever, vinyl thumb grip, stainless steel spring, brass valve, nitrile rubber seals, and nickel-plated brass tip provide superior corrosion resistance

Part

D204-30SB

Pistol Grip

Features

- Contoured pistol-grip for safe, comfortable handling, even with greasy hands
- Convenient hang-up hook
- 1/4" female NPT inlet
- Safety glasses or shield must be worn when using any blow gun 

Specifications

- Conforms to US Department of Labor, OSHA Standard 1910.242 (B) allowing a maximum of **30 PSI** outlet pressure at the nozzle when dead-ended
- Conforms to US Department of Labor, OSHA Standard 1910.95 regulating noise level exposure
- Excepts all standard 1/8" tips and extensions
- **150 PSI** maximum inlet



Part #

PG700

Extended Nozzle Pistol Grip

Features

- Variable output trigger enables user to control air flow
- Slender 5" extended nozzle allows access to hard-to-reach places
- Lightweight and ergonomic design reduces user fatigue
- Side holes allow air to escape if nozzle tip is dead-ended, thus preventing back pressure buildup
- 1/4" female NPT inlet
- Safety glasses or shield must be worn when using any blow gun 

Materials

- Spring: stainless steel
- Body: polymer

Specifications

- Models that are designated as safety conform to OSHA standards for noise levels (1910.95) and **30 PSI** dead-end pressure (1910.242B)
- Pressure rating: **150 PSI**
- Temperature rating: **-40°F to 165°F (-40°C to 73°C)**



Part #

ENBG1

NOTE: Compressed air service only

Safety Tip

Features

- 1/8" male NPT connection
- Can be used with all Dixon[®] Air Chief lever operated blow guns as well as most blow guns from other manufacturers

Nickel-Plated Brass Part #

SST10

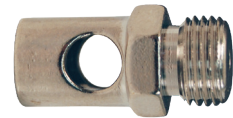

Rubber Non-Safety Tip

Features

- 1/8" male NPT connection
- Can be used with all Dixon Air Chief lever operated blow guns as well as most blow guns from other manufacturers

Rubber Coated Nickel-Plated Brass Part #

D201RT



Extensions

Features

- Supplied with 1/8" male NPT connections
- Allow easier access to blow-off applications in high or hard to reach places
- Can be used with all Dixon Air Chief lever operated blow guns as well as most blow guns from other manufacturers
- Brass base with a rugged steel extension tube, all nickel-plated

Size Extension	Part #
6"	BGE6
10"	BGE10
12"	BGE12
18"	BGE18
24"	BGE24



Non-Safety Blow Guns

Non-safety blow guns do not have a safety by-pass to prevent buildup of tip pressure in the event of tip blockage. They may be used for cleaning purposes only if the air supply (inlet pressure) has been reduced to **30 PSI** or less.



Features

- Designed to comfortably fit the contour of the hand, minimizing user fatigue
- Ergonomic large lever with vinyl grip allows for easy air flow activation
- 1/4" female NPT inlet

Brass Tip

The ventless, nickel-plated tip provides the most economical means of achieving a concentrated stream of air for many blow-off applications. All other components and design features are the same as our Air Chief safety blow gun (D204-30). Must be used on air lines having a maximum regulated pressure of **30 PSI** in order to comply with OSHA Standard 1910.242 (B). Safety glasses or shield must be worn when using any blow gun.



Feature

- Chrome-plated zinc die cast body, nickel-plated steel lever, vinyl thumb grip, stainless steel spring, brass valve, nitrile rubber seals, and ventless, nickel-plated brass tip provide superior corrosion resistance

Part

D605

Rubber Tip

The rubber tip will not scratch or mar delicate surfaces. The conical, rubber tip can also be used to create a seal between the blow gun and fluid lines (or any other opening). Base of the tip is nickel-plated brass for additional corrosion resistance. Must be used on air lines having a maximum regulated pressure of **30 PSI** in order to comply with OSHA Standard 1910.242 (B). Safety glasses or shield must be worn when using any blow gun.



Feature

- Chrome-plated zinc die cast body, nickel-plated steel lever, vinyl thumb grip, stainless steel spring, brass valve, nitrile rubber seals, and rubber tip with a nickel-plated brass base provide superior corrosion resistance

Part

D201

Safety Vented Ball Valves

Applications

- For air service only
- Vent downstream air in accordance with OSHA regulation 1910.147 for pneumatic systems

Features

- Pressure rating: **600 PSI**
- Brass valve
- Chromium-plated ball
- RTFE seats and stuffing box ring
- Blow-out proof stem design
- Adjustable packing gland



female NPT x female NPT

Size	Port	Brass Part #
1/4"	full	BBV25LV
3/8"	full	BBV38LV
1/2"	full	BBV50LV
3/4"	standard	BBV75LV
1"	standard	BBV100LV
1-1/4"	standard	BBV125LV
1-1/2"	standard	BBV150LV
2"	standard	BBV200LV

NOTE: Valve closed and draining. Upstream seat stop air flow. Downstream system is vented to atmosphere.

Coil-Chief Self-Storing Air Hose

fittings included

Feature

- Supplied with swivel on one end

Hose I.D.	Length	Male NPT	Working Pressure at 70°F	Nylon Part #
1/4"	12'	1/4"	185	CC1412
1/4"	25'	1/4"	185	CC1425
1/4"	50'	1/4"	185	CC1450
3/8"	25'	3/8"	165	CC3825
3/8"	50'	3/8"	165	CC3850
1/2"	25'	1/2"	170	CC1225
1/2"	50'	1/2"	170	CC1250



bulk hose - no fittings

Feature

- Needs assembly kits for ends

Hose I.D.	Length	Nylon Part #
1/4"	100'	CC14100B
3/8"	100'	CC38100B
1/2"	100'	CC12100B



Assembly Kits

Feature

- Kits include fittings, nut, insert, ferrule, and spring guard

Size	Fitting Type	Part #
1/4"	rigid male	RK090
1/4"	swivel male	RK092
3/8"	rigid male	RK110
3/8"	swivel male	RK112
1/2"	rigid male	RK118
1/2"	swivel male	RK119



RK110 assembly kit

Polyurethane Self-Storing Air Hose

(fittings included)

Features

- Extremely flexible - resists kinking
- Impervious to abrasions, heat, and oil
- Superior elasticity and coil memory
- Both ends swivel

Hose I.D.	Length	Male NPT	Working Pressure (PSI)	Polyurethane Part #
1/4"	10'	1/4"	145	PU1410
1/4"	15'	1/4"	145	PU1415
1/4"	25'	1/4"	145	PU1425
3/8"	15'	3/8"	135	PU3815
3/8"	20'	3/8"	135	PU3820
3/8"	25'	3/8"	135	PU3825
3/8"	50'	3/8"	135	PU3850
1/2"	15'	1/2"	155	PU1215



Repair Kits

Tubing Size		Size	Type	Brass Part #
I.D.	O.D.			
1/4"	3/8"	1/4"	swivel male	PSM0404
3/8"	9/16"	1/4"	swivel male	PSM0604



